



Alienware m15 Service Manual

Notes, cautions, and warnings

-  **NOTE:** A NOTE indicates important information that helps you make better use of your product.
 -  **CAUTION:** A CAUTION indicates either potential damage to hardware or loss of data and tells you how to avoid the problem.
 -  **WARNING:** A WARNING indicates a potential for property damage, personal injury, or death.
-

Contents

Before working inside your computer	8
Before you begin	8
After working inside your computer	9
Safety instructions	10
Electrostatic discharge—ESD protection.....	10
ESD field service kit	11
Components of an ESD field service kit.....	11
ESD protection summary	11
Transporting sensitive components.....	12
Lifting equipment	12
Recommended tools	13
Screw list	14
Removing the base cover	16
Procedure.....	16
Replacing the base cover	19
Procedure.....	19
Removing the battery (half-length)	22
Prerequisites.....	22
Procedure.....	22
Replacing the battery (half-length)	23
Procedure	23
Post-requisites.....	23
Removing the battery (full-length)	24
Prerequisites.....	24
Procedure.....	24
Replacing the battery (full-length)	25
Procedure	25
Post-requisites.....	25
Removing the hard drive	26
Prerequisites.....	26
Procedure.....	26

Replacing the hard drive.....	28
Procedure.....	28
Post-requisites.....	30
Removing the memory modules.....	31
Prerequisites.....	31
Procedure.....	31
Replacing the memory modules.....	33
Procedure	33
Post-requisites.....	33
Removing the heat sink.....	34
Prerequisites.....	34
Procedure.....	34
Replacing the heat sink.....	36
Procedure	36
Post-requisites.....	37
Removing the fans.....	38
Prerequisites.....	38
Procedure.....	38
Replacing the fans.....	40
Procedure	40
Post-requisites.....	41
Removing the wireless card.....	42
Prerequisites.....	42
Procedure.....	42
Replacing the wireless card.....	44
Procedure.....	44
Post-requisites.....	45
Removing the solid-state drive/Intel Optane memory module.....	46
Prerequisites.....	46
Procedure to remove M.2 2230 solid-state drive.....	46
Procedure to remove M.2 2280 solid-state drive.....	47
Replacing the solid-state drive/Intel Optane memory module.....	49
Procedure to replace M.2 2230 solid-state drive.....	49
Procedure to replace M.2 2280 solid-state drive.....	51
Post-requisites.....	52

Removing the I/O board.....	53
Prerequisites.....	53
Procedure.....	53
Replacing the I/O board.....	55
Procedure.....	55
Post-requisites.....	56
Removing the coin-cell battery.....	57
Prerequisites.....	57
Procedure.....	57
Replacing the coin-cell battery.....	58
Procedure.....	58
Post-requisites.....	58
Removing the touchpad.....	59
Prerequisites.....	59
Procedure.....	59
Replacing the touchpad.....	60
Procedure.....	60
Post-requisites.....	61
Removing the speakers.....	62
Prerequisites.....	62
Procedure.....	62
Replacing the speakers.....	63
Procedure	63
Post-requisites.....	63
Removing the power-adapter port.....	64
Prerequisites.....	64
Procedure.....	64
Replacing the power-adapter port.....	65
Procedure.....	65
Post-requisites.....	65
Removing the display assembly.....	66
Prerequisites.....	66
Procedure.....	66

Replacing the display assembly.....	69
Procedure.....	69
Post-requisites.....	71
Removing the system board.....	72
Prerequisites.....	72
Procedure.....	72
Replacing the system board.....	76
Procedure	76
Post-requisites.....	78
Entering the Service Tag in the BIOS setup program.....	78
Removing the power-button board.....	79
Prerequisites.....	79
Procedure.....	79
Replacing the power-button board.....	80
Procedure.....	80
Post-requisites.....	80
Removing the keyboard.....	81
Prerequisites.....	81
Procedure.....	81
Replacing the keyboard.....	83
Procedure.....	83
Post-requisites.....	90
Removing the palm rest.....	91
Prerequisites.....	91
Procedure.....	91
Replacing the palm rest.....	93
Procedure.....	93
Post-requisites.....	93
Device drivers.....	95
Intel Chipset Software Installation Utility.....	95
Video drivers.....	95
Intel Serial IO driver.....	95
Intel Trusted Execution Engine Interface.....	95
Intel Virtual Button driver.....	95
Wireless and Bluetooth drivers.....	95

System setup.....	96
BIOS overview.....	96
Entering BIOS setup program.....	96
Navigation keys.....	96
Boot Sequence.....	96
System setup options.....	97
Clearing CMOS settings.....	100
Clearing BIOS (System Setup) and System passwords.....	101
Troubleshooting.....	102
Flashing the BIOS.....	102
Flashing BIOS (USB key).....	102
Enhanced Pre-Boot System Assessment (ePSA) diagnostics.....	102
Running the ePSA diagnostics.....	103
System diagnostic lights.....	103
Enabling Intel Optane memory.....	104
Disabling Intel Optane memory.....	104
WiFi power cycle.....	104
Flea power release.....	105
Getting help and contacting Alienware.....	106
Self-help resources.....	106
Contacting Alienware.....	106

Before working inside your computer

 **NOTE:** The images in this document may differ from your computer depending on the configuration you ordered.

Before you begin

- 1 Save and close all open files and exit all open applications.
- 2 Shut down your computer. Click **Start** →  **Power** → **Shut down**.

 **NOTE:** If you are using a different operating system, see the documentation of your operating system for shut-down instructions.

- 3 Disconnect your computer and all attached devices from their electrical outlets.
- 4 Disconnect all attached network devices and peripherals, such as keyboard, mouse, and monitor from your computer.
- 5 Remove any media card and optical disc from your computer, if applicable.









After working inside your computer

 **CAUTION: Leaving stray or loose screws inside your computer may severely damage your computer.**

- 1 Replace all screws and ensure that no stray screws remain inside your computer.
- 2 Connect any external devices, peripherals, or cables you removed before working on your computer.
- 3 Replace any media cards, discs, or any other parts that you removed before working on your computer.
- 4 Connect your computer and all attached devices to their electrical outlets.
- 5 Turn on your computer.

Safety instructions

Use the following safety guidelines to protect your computer from potential damage and ensure your personal safety.

-  **WARNING:** Before working inside your computer, read the safety information that shipped with your computer. For more safety best practices, see the Regulatory Compliance home page at www.dell.com/regulatory_compliance.
-  **WARNING:** Disconnect all power sources before opening the computer cover or panels. After you finish working inside the computer, replace all covers, panels, and screws before connecting to the electrical outlet.
-  **CAUTION:** To avoid damaging the computer, ensure that the work surface is flat and clean.
-  **CAUTION:** To avoid damaging the components and cards, handle them by their edges, and avoid touching pins and contacts.
-  **CAUTION:** You should only perform troubleshooting and repairs as authorized or directed by the Dell technical assistance team. Damage due to servicing that is not authorized by Dell is not covered by your warranty. See the safety instructions that shipped with the product or at www.dell.com/regulatory_compliance.
-  **CAUTION:** Before touching anything inside your computer, ground yourself by touching an unpainted metal surface, such as the metal at the back of the computer. While you work, periodically touch an unpainted metal surface to dissipate static electricity, which could harm internal components.
-  **CAUTION:** When you disconnect a cable, pull on its connector or on its pull tab, not on the cable itself. Some cables have connectors with locking tabs or thumb-screws that you must disengage before disconnecting the cable. When disconnecting cables, keep them evenly aligned to avoid bending any connector pins. When connecting cables, ensure that the ports and connectors are correctly oriented and aligned.
-  **CAUTION:** Press and eject any installed card from the media-card reader.

Electrostatic discharge—ESD protection

ESD is a major concern when you handle electronic components, especially sensitive components such as expansion cards, processors, memory DIMMs, and system boards. Very slight charges can damage circuits in ways that may not be obvious, such as intermittent problems or a shortened product life span. As the industry pushes for lower power requirements and increased density, ESD protection is an increasing concern.

Due to the increased density of semiconductors used in recent Dell products, the sensitivity to static damage is now higher than in previous Dell products. For this reason, some previously approved methods of handling parts are no longer applicable.

Two recognized types of ESD damage are catastrophic and intermittent failures.

- **Catastrophic** – Catastrophic failures represent approximately 20 percent of ESD-related failures. The damage causes an immediate and complete loss of device functionality. An example of catastrophic failure is a memory DIMM that has received a static shock and immediately generates a "No POST/No Video" symptom with a beep code emitted for missing or nonfunctional memory.
- **Intermittent** – Intermittent failures represent approximately 80 percent of ESD-related failures. The high rate of intermittent failures means that most of the time when damage occurs, it is not immediately recognizable. The DIMM receives a static shock, but the tracing is merely weakened and does not immediately produce outward symptoms related to the damage. The weakened trace may take weeks or months to melt, and in the meantime may cause degradation of memory integrity, intermittent memory errors, etc.

The more difficult type of damage to recognize and troubleshoot is the intermittent (also called latent or "walking wounded") failure.

Perform the following steps to prevent ESD damage:

- Use a wired ESD wrist strap that is properly grounded. The use of wireless anti-static straps is no longer allowed; they do not provide adequate protection. Touching the chassis before handling parts does not ensure adequate ESD protection on parts with increased sensitivity to ESD damage.
- Handle all static-sensitive components in a static-safe area. If possible, use anti-static floor pads and workbench pads.

- When unpacking a static-sensitive component from its shipping carton, do not remove the component from the anti-static packing material until you are ready to install the component. Before unwrapping the anti-static packaging, ensure that you discharge static electricity from your body.
- Before transporting a static-sensitive component, place it in an anti-static container or packaging.

ESD field service kit

The unmonitored Field Service kit is the most commonly used service kit. Each Field Service kit includes three main components: anti-static mat, wrist strap, and bonding wire.

Components of an ESD field service kit

The components of an ESD field service kit are:

- **Anti-Static Mat** – The anti-static mat is dissipative and parts can be placed on it during service procedures. When using an anti-static mat, your wrist strap should be snug and the bonding wire should be connected to the mat and to any bare metal on the system being worked on. Once deployed properly, service parts can be removed from the ESD bag and placed directly on the mat. ESD-sensitive items are safe in your hand, on the ESD mat, in the system, or inside a bag.
- **Wrist Strap and Bonding Wire** – The wrist strap and bonding wire can be either directly connected between your wrist and bare metal on the hardware if the ESD mat is not required, or connected to the anti-static mat to protect hardware that is temporarily placed on the mat. The physical connection of the wrist strap and bonding wire between your skin, the ESD mat, and the hardware is known as bonding. Use only Field Service kits with a wrist strap, mat, and bonding wire. Never use wireless wrist straps. Always be aware that the internal wires of a wrist strap are prone to damage from normal wear and tear, and must be checked regularly with a wrist strap tester in order to avoid accidental ESD hardware damage. It is recommended to test the wrist strap and bonding wire at least once per week.
- **ESD Wrist Strap Tester** – The wires inside of an ESD strap are prone to damage over time. When using an unmonitored kit, it is a best practice to regularly test the strap prior to each service call, and at a minimum, test once per week. A wrist strap tester is the best method for doing this test. If you do not have your own wrist strap tester, check with your regional office to find out if they have one. To perform the test, plug the wrist-strap's bonding-wire into the tester while it is strapped to your wrist and push the button to test. A green LED is lit if the test is successful; a red LED is lit and an alarm sounds if the test fails.
- **Insulator Elements** – It is critical to keep ESD sensitive devices, such as plastic heat sink casings, away from internal parts that are insulators and often highly charged.
- **Working Environment** – Before deploying the ESD Field Service kit, assess the situation at the customer location. For example, deploying the kit for a server environment is different than for a desktop or portable environment. Servers are typically installed in a rack within a data center; desktops or portables are typically placed on office desks or cubicles. Always look for a large open flat work area that is free of clutter and large enough to deploy the ESD kit with additional space to accommodate the type of system that is being repaired. The workspace should also be free of insulators that can cause an ESD event. On the work area, insulators such as Styrofoam and other plastics should always be moved at least 12 inches or 30 centimeters away from sensitive parts before physically handling any hardware components.
- **ESD Packaging** – All ESD-sensitive devices must be shipped and received in static-safe packaging. Metal, static-shielded bags are preferred. However, you should always return the damaged part using the same ESD bag and packaging that the new part arrived in. The ESD bag should be folded over and taped shut and all the same foam packing material should be used in the original box that the new part arrived in. ESD-sensitive devices should be removed from packaging only at an ESD-protected work surface, and parts should never be placed on top of the ESD bag because only the inside of the bag is shielded. Always place parts in your hand, on the ESD mat, in the system, or inside an anti-static bag.
- **Transporting Sensitive Components** – When transporting ESD sensitive components such as replacement parts or parts to be returned to Dell, it is critical to place these parts in anti-static bags for safe transport.

ESD protection summary

It is recommended that all field service technicians use the traditional wired ESD grounding wrist strap and protective anti-static mat at all times when servicing Dell products. In addition, it is critical that technicians keep sensitive parts separate from all insulator parts while performing service and that they use anti-static bags for transporting sensitive components.

Transporting sensitive components

When transporting ESD sensitive components such as replacement parts or parts to be returned to Dell, it is critical to place these parts in anti-static bags for safe transport.

Lifting equipment

Adhere to the following guidelines when lifting heavy weight equipment:

 **CAUTION: Do not lift greater than 50 pounds. Always obtain additional resources or use a mechanical lifting device.**

- 1 Get a firm balanced footing. Keep your feet apart for a stable base, and point your toes out.
- 2 Tighten stomach muscles. Abdominal muscles support your spine when you lift, offsetting the force of the load.
- 3 Lift with your legs, not your back.
- 4 Keep the load close. The closer it is to your spine, the less force it exerts on your back.
- 5 Keep your back upright, whether lifting or setting down the load. Do not add the weight of your body to the load. Avoid twisting your body and back.
- 6 Follow the same techniques in reverse to set the load down.

Recommended tools

The procedures in this document may require the following tools:

- Philips screwdriver #1
- Flat-head screwdriver
- Plastic scribe













Screw list







 **NOTE:** When removing screws from a component, it is recommended to note the screw type, the quantity of screws, and then place them in a screw storage box. This is to ensure that the correct number of screws and correct screw type is restored when the component is replaced.

 **NOTE:** Some computers have magnetic surfaces. Ensure that the screws are not left attached to such surface when replacing a component.

 **NOTE:** Screw color may vary with the configuration ordered.

Table 1. Screw list

Component	Secured to	Screw type	Quantity	Screw image
Base cover	Palm-rest assembly	M2.5x10	6	
Base cover	Palm-rest assembly	M2.5x10	2	
Battery (Half-length)	Palm-rest assembly	M2x5	4	
Battery (Full-length)	Palm-rest assembly	M2x5	6	
Hard-drive assembly	Palm-rest assembly	M2x5	4	
Heat-sink assembly	System board	M2x3	5	
Heat-sink assembly	System board	M2x5	1	
Fan	Heat sink	M2x3	2	
Wireless-card bracket	System board	M2x3	1	
Solid-state drive bracket	Palm-rest assembly	M2x3	1	
Solid-state drive	Solid-state drive bracket	M2x2	1	
I/O board	Palm-rest assembly	M2x5	1	
Touchpad	Palm-rest assembly	M2x2.5	4	

Component	Secured to	Screw type	Quantity	Screw image
Hinges	Palm-rest assembly	M2.5x2.5	2	
Power-adapter port	System board and palm-rest assembly	M2x3	1	
Power-button board	Palm-rest assembly	M2x3	3	
USB Type-C port bracket	System board	M2x3	1	
System board	Palm-rest assembly	M2x2	5	
Keyboard bracket	Palm-rest assembly	M1.2x2.2	8	
Keyboard	Palm-rest assembly	M1.2x1.9	33	

Removing the base cover

WARNING: Before working inside your computer, read the safety information that shipped with your computer and follow the steps in [Before working inside your computer](#). After working inside your computer, follow the instructions in [After working inside your computer](#). For more safety best practices, see the Regulatory Compliance home page at www.dell.com/regulatory_compliance.

Procedure

- 1 Loosen the three captive screws on the base cover.
- 2 Remove the six screws (M2.5x10) that secure the base cover to the palm-rest assembly.
- 3 Remove the two screws (M2.5x10) from the back that secure the base cover to the palm-rest assembly.

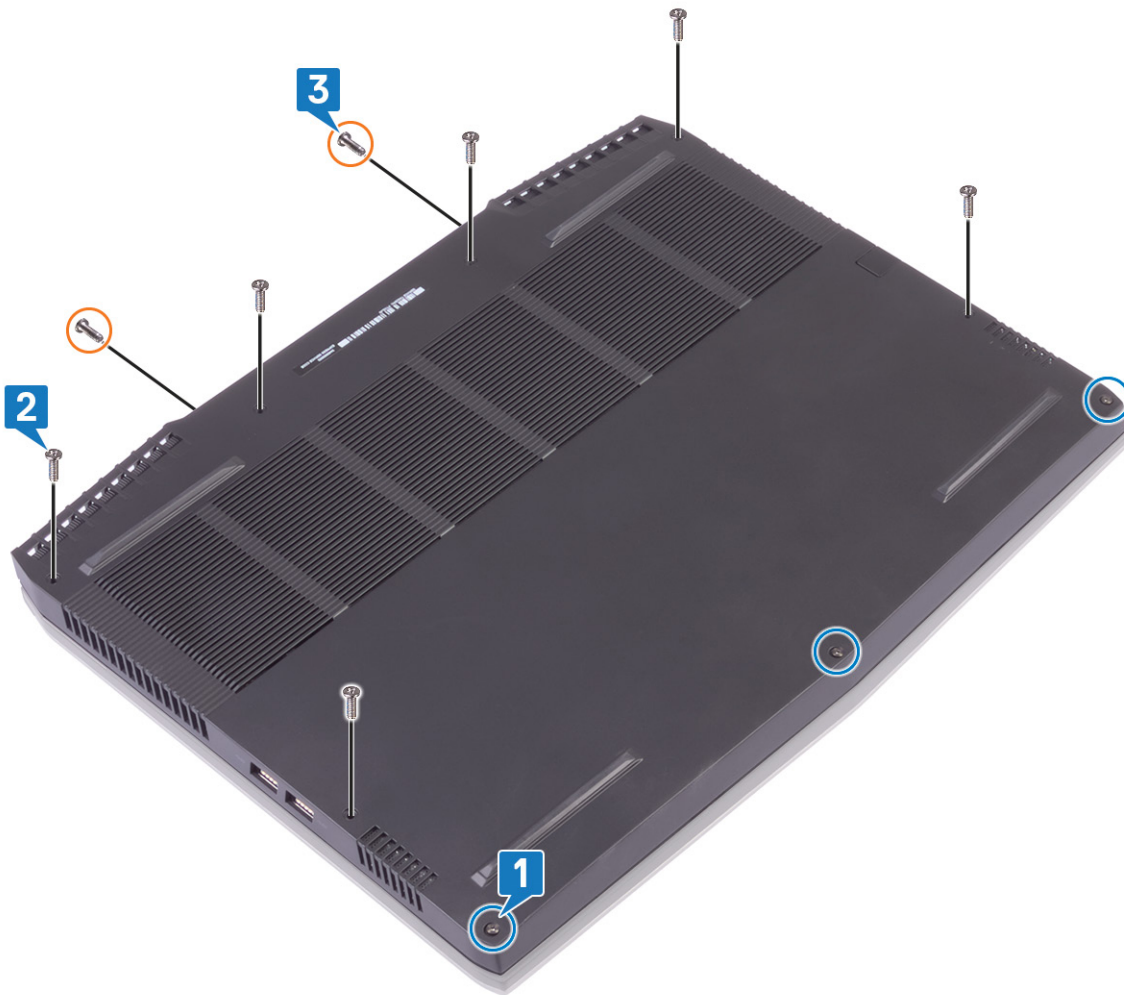

- 4 Using a plastic scribe, pry the base cover from the computer base.

5 Rotate the base cover from front to back and remove the base cover off the palm-rest assembly.

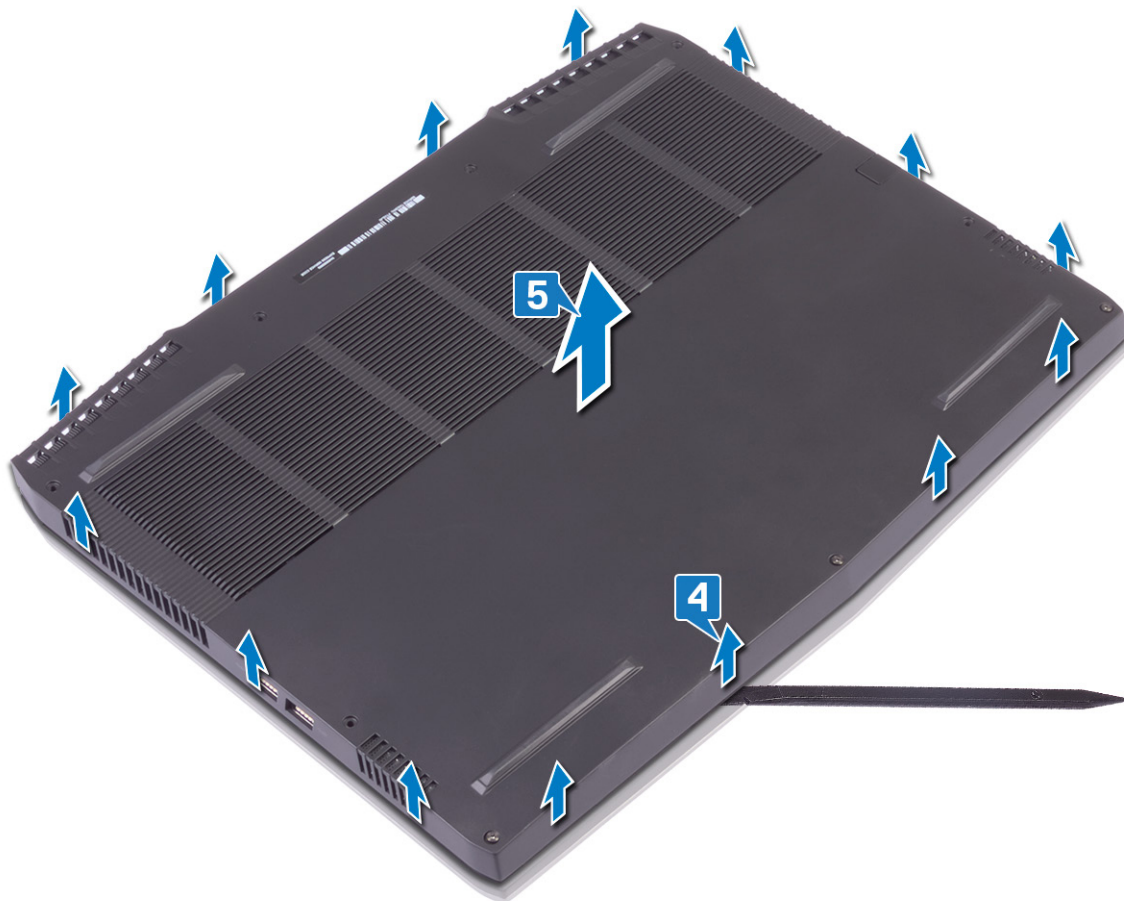

- Using the pull tab, disconnect the battery cable from the system board.

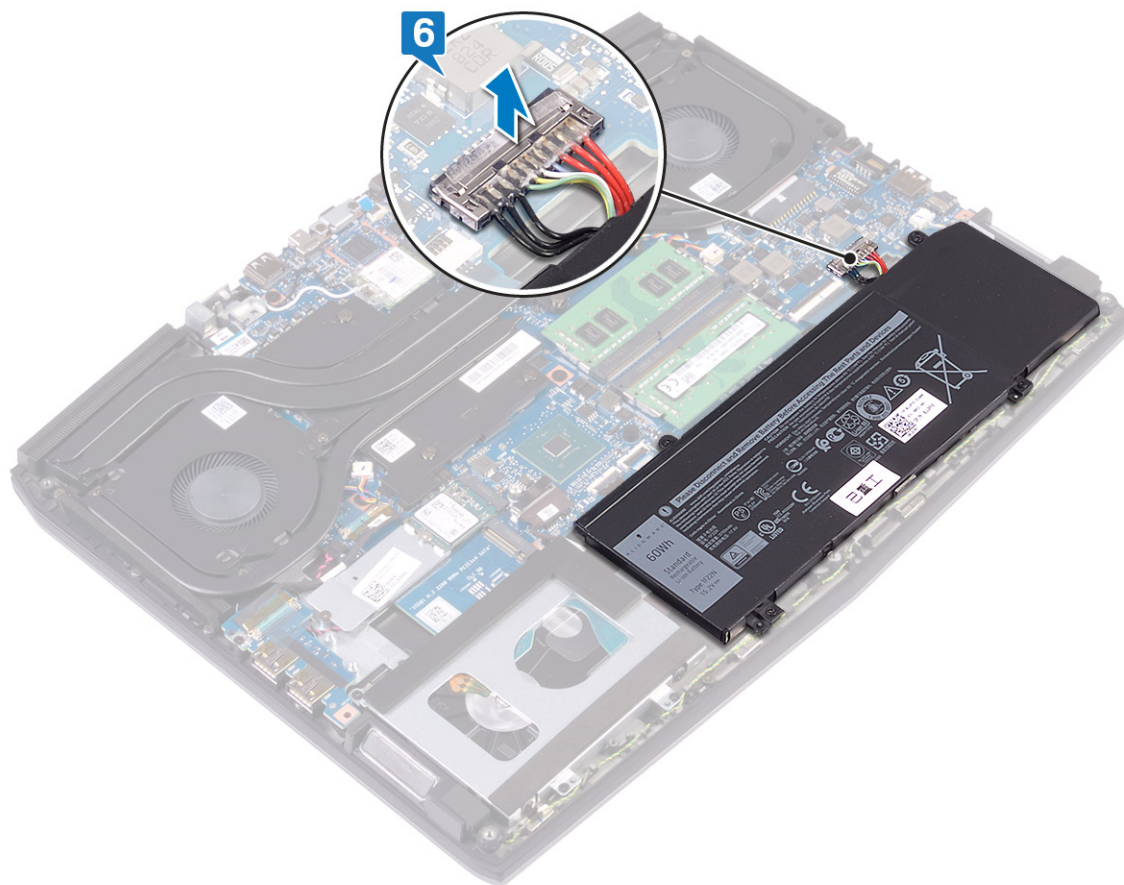

- Press and hold the power button for 5 seconds to ground the computer and drain the flea power.

Replacing the base cover

WARNING: Before working inside your computer, read the safety information that shipped with your computer and follow the steps in [Before working inside your computer](#). After working inside your computer, follow the instructions in [After working inside your computer](#). For more safety best practices, see the Regulatory Compliance home page at www.dell.com/regulatory_compliance.

Procedure

- 1 Connect the battery cable to the system board.

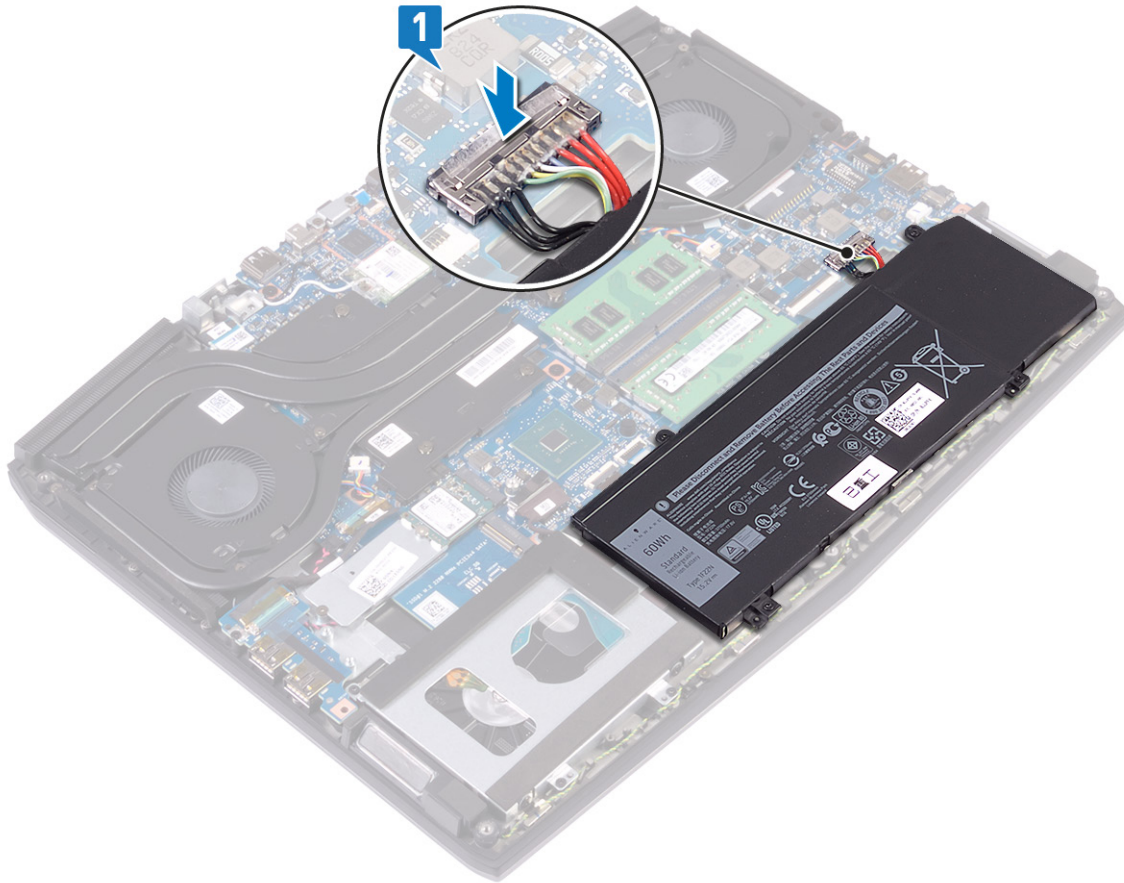

- 2 Rotate the cover from back to front and place the base cover on the palm-rest assembly, and snap the base cover into place.



- 3 Tighten the captive screws on the base cover.
- 4 Replace the six screws (M2.5x10) that secure the base cover to the palm-rest assembly.

- 5 Replace the two screws (M2.5x10) in the back that secure the base cover to the palm-rest assembly.

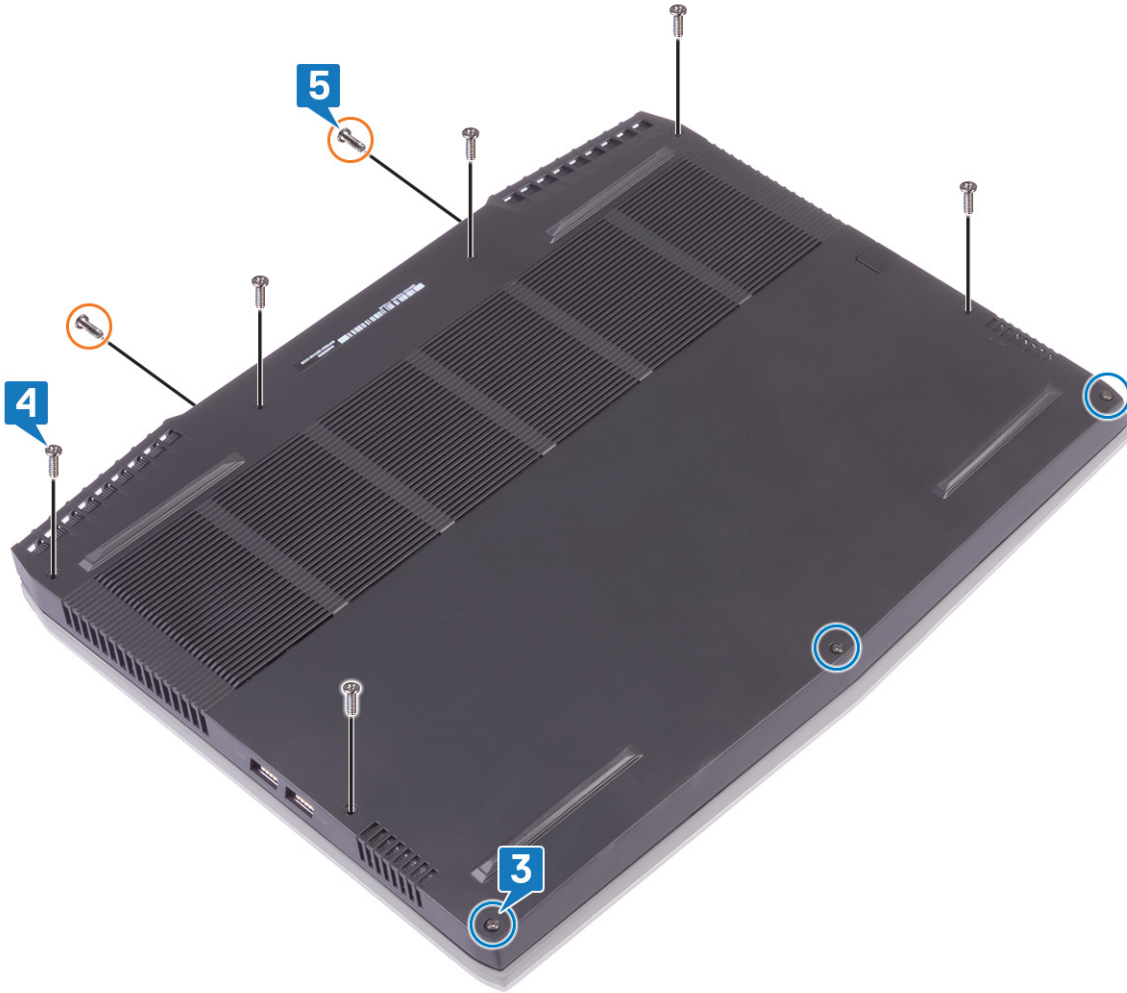

Removing the battery (half-length)

WARNING: Before working inside your computer, read the safety information that shipped with your computer and follow the steps in [Before working inside your computer](#). After working inside your computer, follow the instructions in [After working inside your computer](#). For more safety best practices, see the Regulatory Compliance home page at www.dell.com/regulatory_compliance.

Prerequisites

Remove the [base cover](#).

Procedure

- 1 Using the pull tab, disconnect the battery cable from the system board (applicable only if not disconnected earlier).
- 2 Remove the four screws (M2x5) that secure the battery to the palm-rest assembly.
- 3 Lift the battery off the palm-rest assembly.

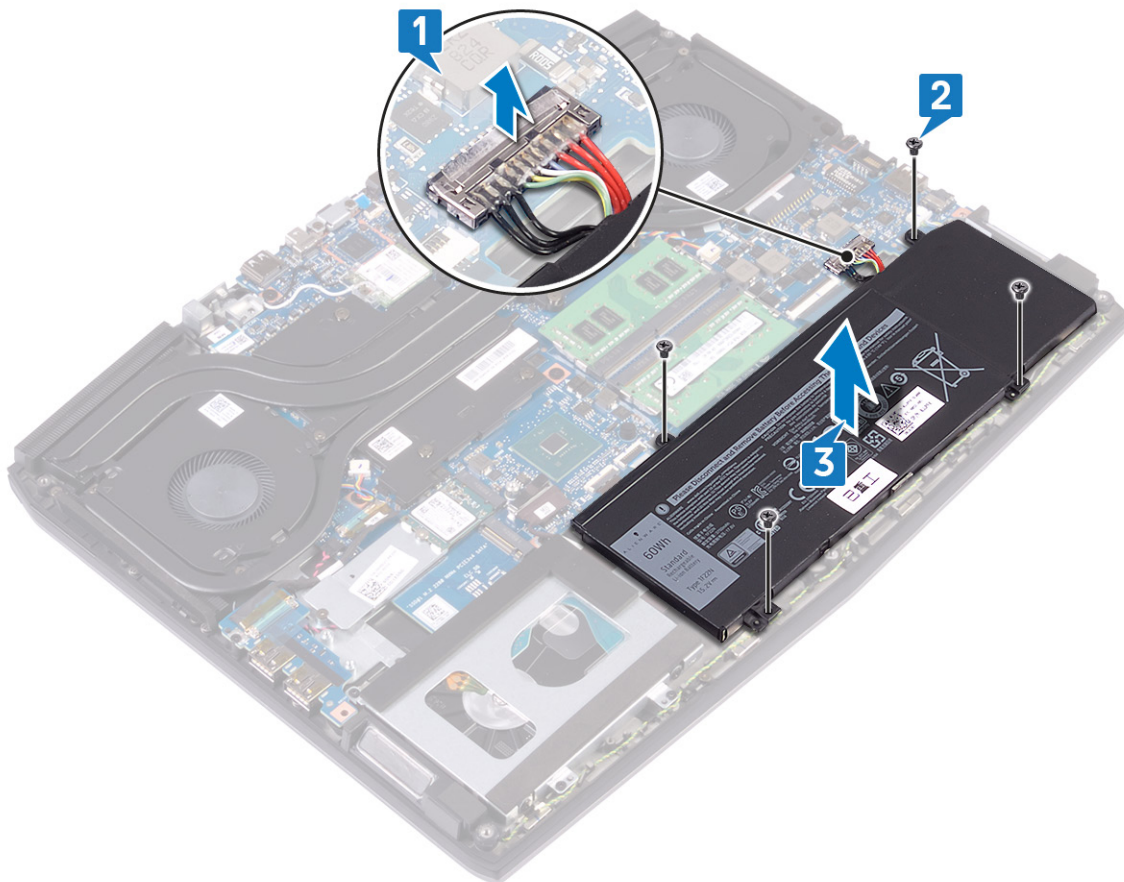

Replacing the battery (half-length)

WARNING: Before working inside your computer, read the safety information that shipped with your computer and follow the steps in [Before working inside your computer](#). After working inside your computer, follow the instructions in [After working inside your computer](#). For more safety best practices, see the Regulatory Compliance home page at www.dell.com/regulatory_compliance.

Procedure

- 1 Align the screw holes on the battery with the screw holes on the palm-rest assembly.
- 2 Replace the four screws (M2x5) that secure the battery to the palm-rest assembly.
- 3 Connect the battery cable to the system board.

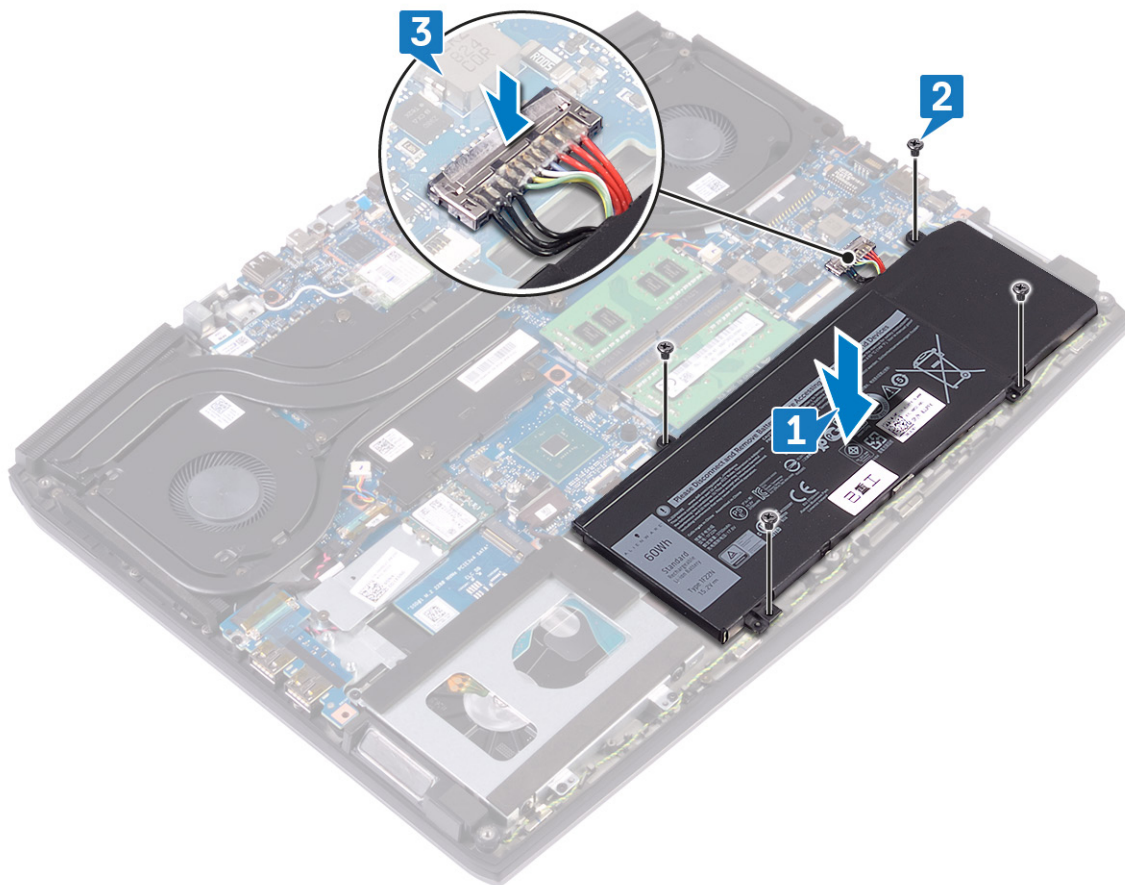

Post-requisites

Replace the [base cover](#).

Removing the battery (full-length)

WARNING: Before working inside your computer, read the safety information that shipped with your computer and follow the steps in [Before working inside your computer](#). After working inside your computer, follow the instructions in [After working inside your computer](#). For more safety best practices, see the Regulatory Compliance home page at www.dell.com/regulatory_compliance.

Prerequisites

Remove the [base cover](#).

Procedure

- 1 Using the pull tab, disconnect the battery cable from the system board (applicable only if not disconnected earlier).
- 2 Remove the six screws (M2x5) that secure the battery to the palm-rest assembly.
- 3 Lift the battery off the palm-rest assembly.

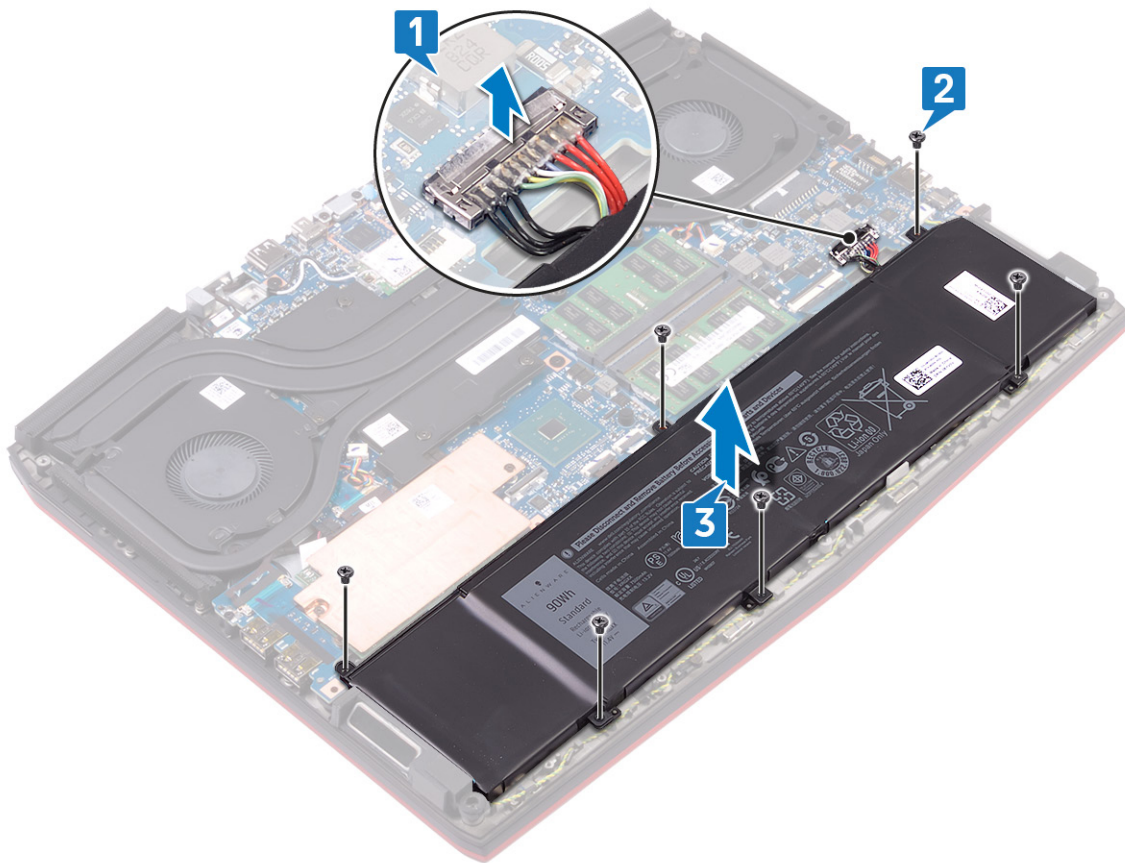

Replacing the battery (full-length)

WARNING: Before working inside your computer, read the safety information that shipped with your computer and follow the steps in [Before working inside your computer](#). After working inside your computer, follow the instructions in [After working inside your computer](#). For more safety best practices, see the Regulatory Compliance home page at www.dell.com/regulatory_compliance.

Procedure

- 1 Align the screw holes on the battery with the screw holes on the palm-rest assembly.
- 2 Replace the six screws (M2x5) that secure the battery to the palm-rest assembly.
- 3 Connect the battery cable to the system board.

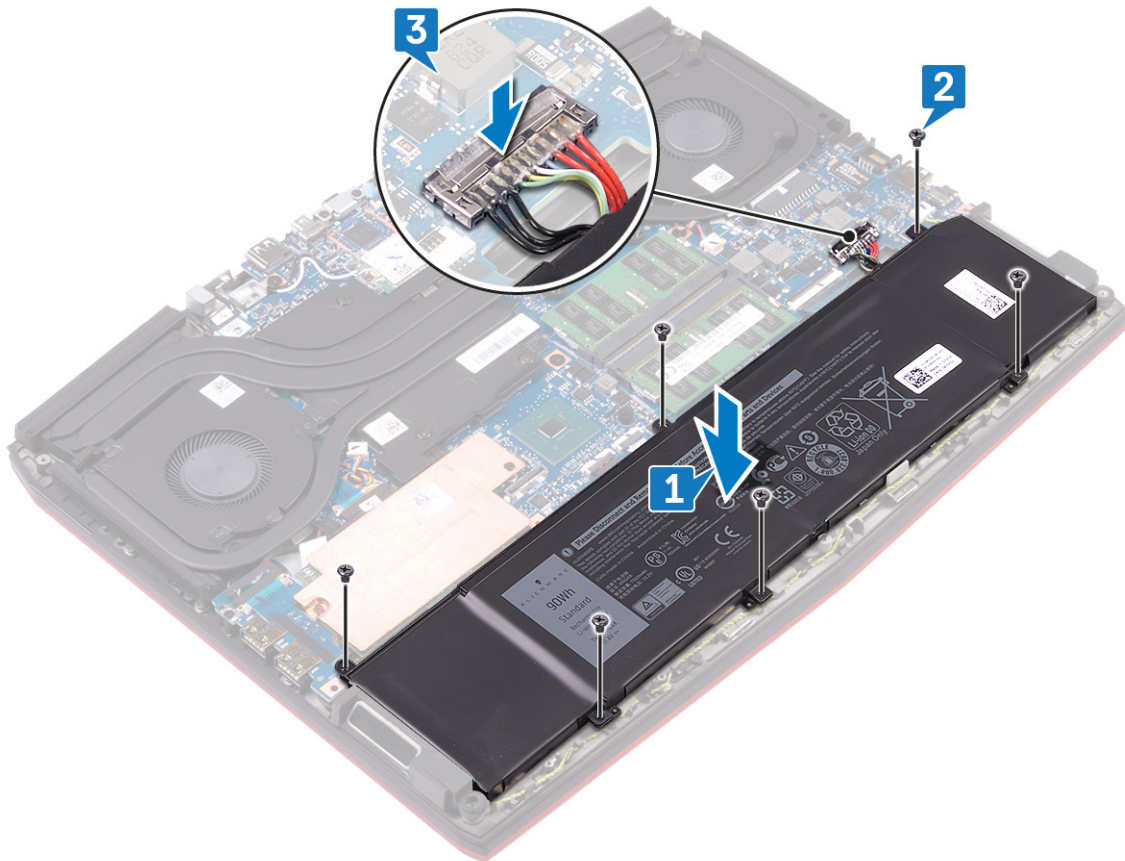

Post-requisites

Replace the [base cover](#).

Removing the hard drive

If your computer is using a SATA storage device accelerated by Intel Optane memory, disable Intel Optane before removing the SATA storage device. For more information about disabling the Intel Optane, see [Disabling Intel Optane](#).

⚠ WARNING: Before working inside your computer, read the safety information that shipped with your computer and follow the steps in [Before working inside your computer](#). After working inside your computer, follow the instructions in [After working inside your computer](#). For more safety best practices, see the Regulatory Compliance home page at www.dell.com/regulatory_compliance.

⚠ CAUTION: Hard drives are fragile. Exercise care when handling the hard drive.

⚠ CAUTION: To avoid data loss, do not remove the hard drive while the computer is in sleep or on state.

Prerequisites

Remove the [base cover](#).

Procedure

✎ NOTE: The hard drive is not available on systems shipped with 6-cell (full-length) battery.

- 1 Using the pull tab, disconnect the hard-drive cable from the system board.
- 2 Remove the four screws (M2x5) that secure the hard-drive assembly to the palm-rest assembly.
- 3 Lift the hard-drive assembly along with its cable off the palm-rest assembly.

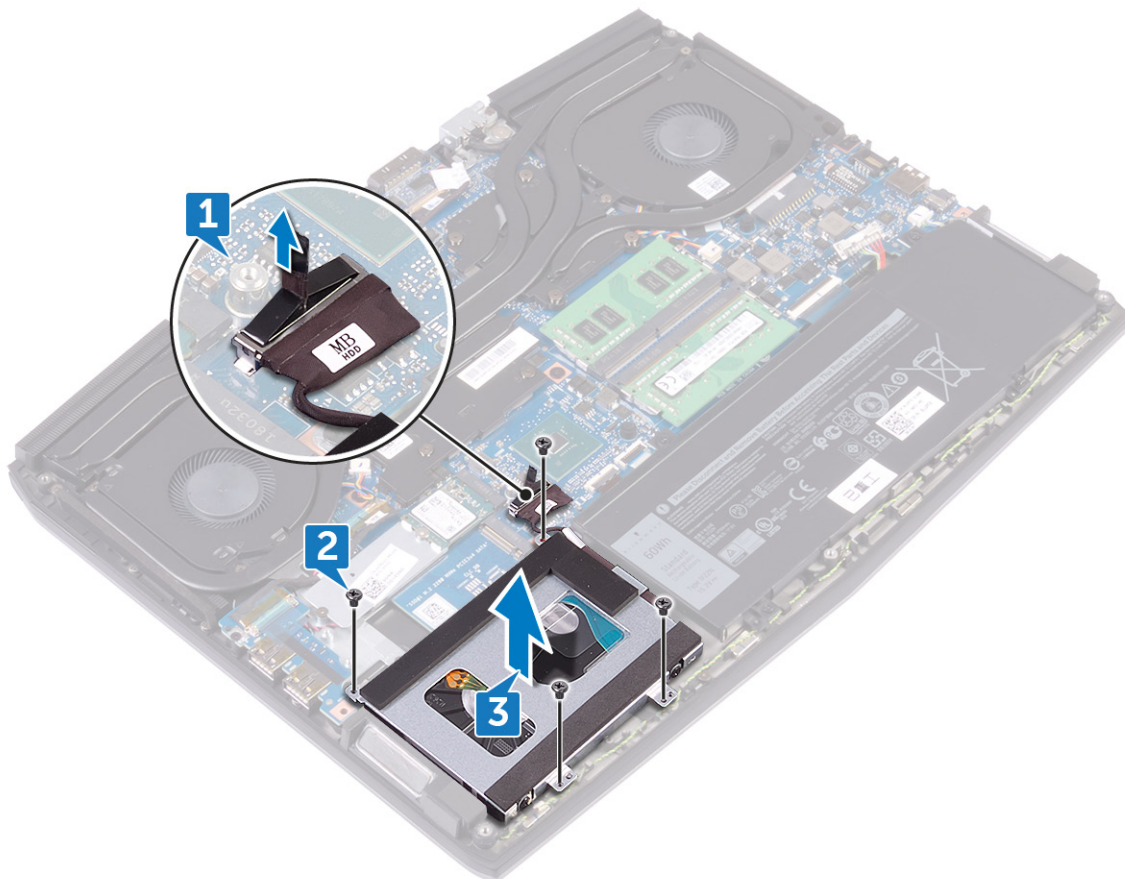

- 4 Remove the four screws (M3x3) that secure the hard-drive bracket to the hard drive.
- 5 Lift the hard drive off the hard-drive bracket.

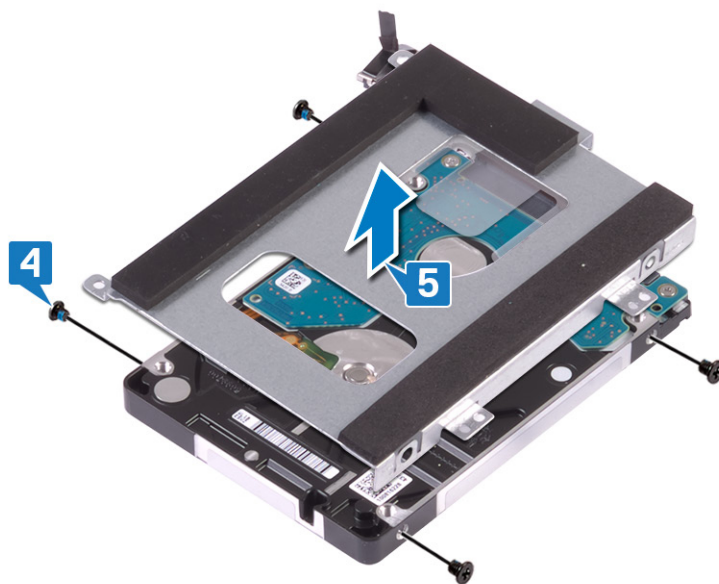

- 6 Disconnect the interposer from the hard-drive assembly.

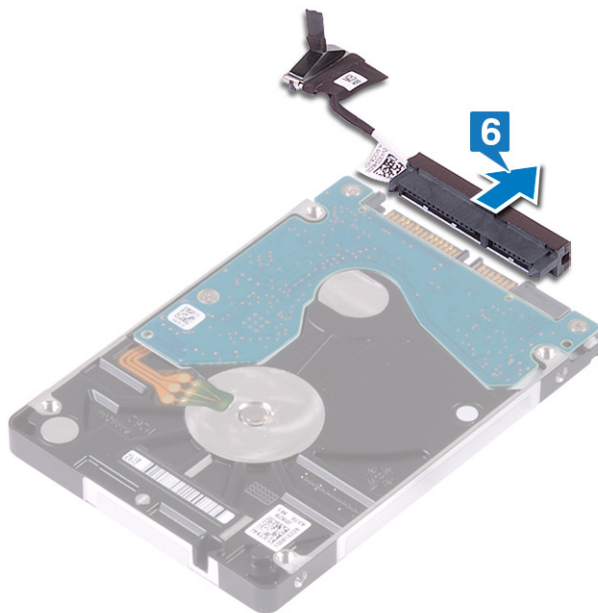

Replacing the hard drive

Enable Intel Optane after replacing the SATA storage. For more information about enabling the Intel Optane, see [Enabling Intel Optane](#).

⚠ WARNING: Before working inside your computer, read the safety information that shipped with your computer and follow the steps in [Before working inside your computer](#). After working inside your computer, follow the instructions in [After working inside your computer](#). For more safety best practices, see the Regulatory Compliance home page at www.dell.com/regulatory_compliance.

⚠ CAUTION: Hard drives are fragile. Exercise care when handling the hard drive.

Procedure

✎ NOTE: The hard drive is not available on systems shipped with 6-cell (full-length) battery.

- 1 Connect the interposer to the hard-drive assembly.

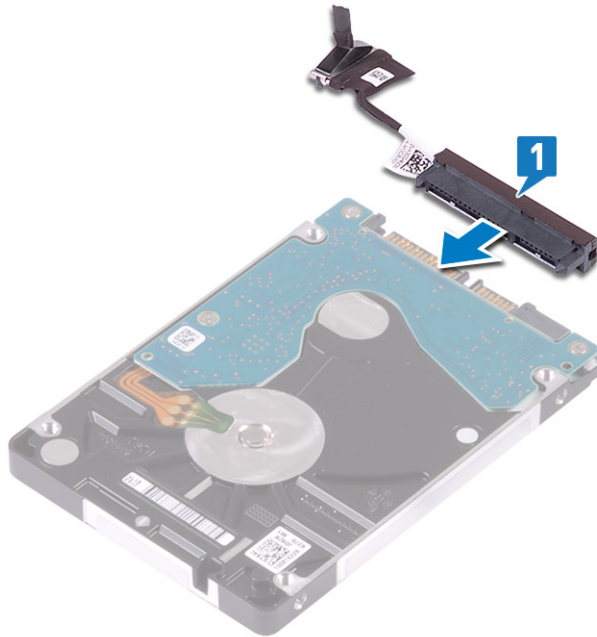

- 2 Place the hard-drive bracket on the hard drive and align the screw holes on the hard-drive bracket with the screw holes on the hard drive.

- 3 Replace the four screws (M3x3) that secure the hard-drive bracket to the hard drive.

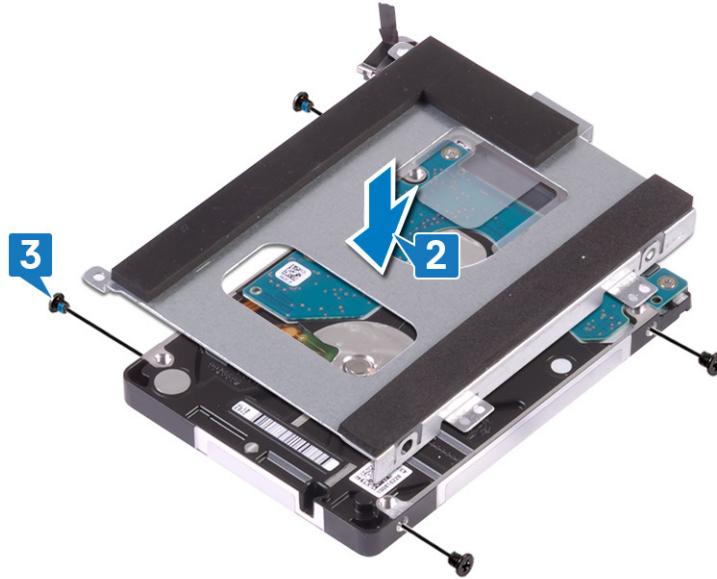

- 4 Align the screw holes on the hard-drive assembly with the screw holes on the palm-rest assembly.
- 5 Replace the four screws (M2x5) that secure the hard-drive assembly to the palm-rest assembly.
- 6 Connect the hard-drive cable to the system board.

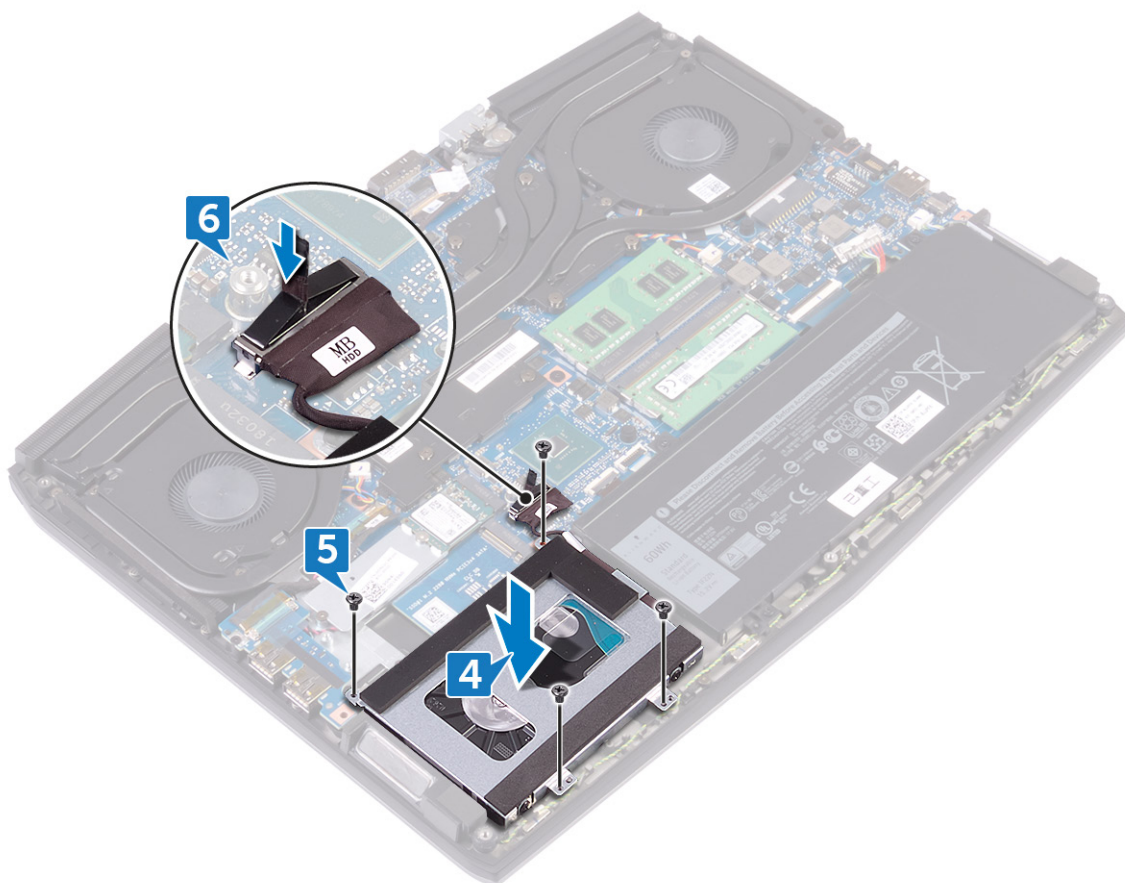

Post-requisites

Replace the [base cover](#).

Removing the memory modules

WARNING: Before working inside your computer, read the safety information that shipped with your computer and follow the steps in [Before working inside your computer](#). After working inside your computer, follow the instructions in [After working inside your computer](#). For more safety best practices, see the Regulatory Compliance home page at www.dell.com/regulatory_compliance.

Prerequisites

Remove the [base cover](#).

Procedure

- 1 Locate the memory modules on your computer.

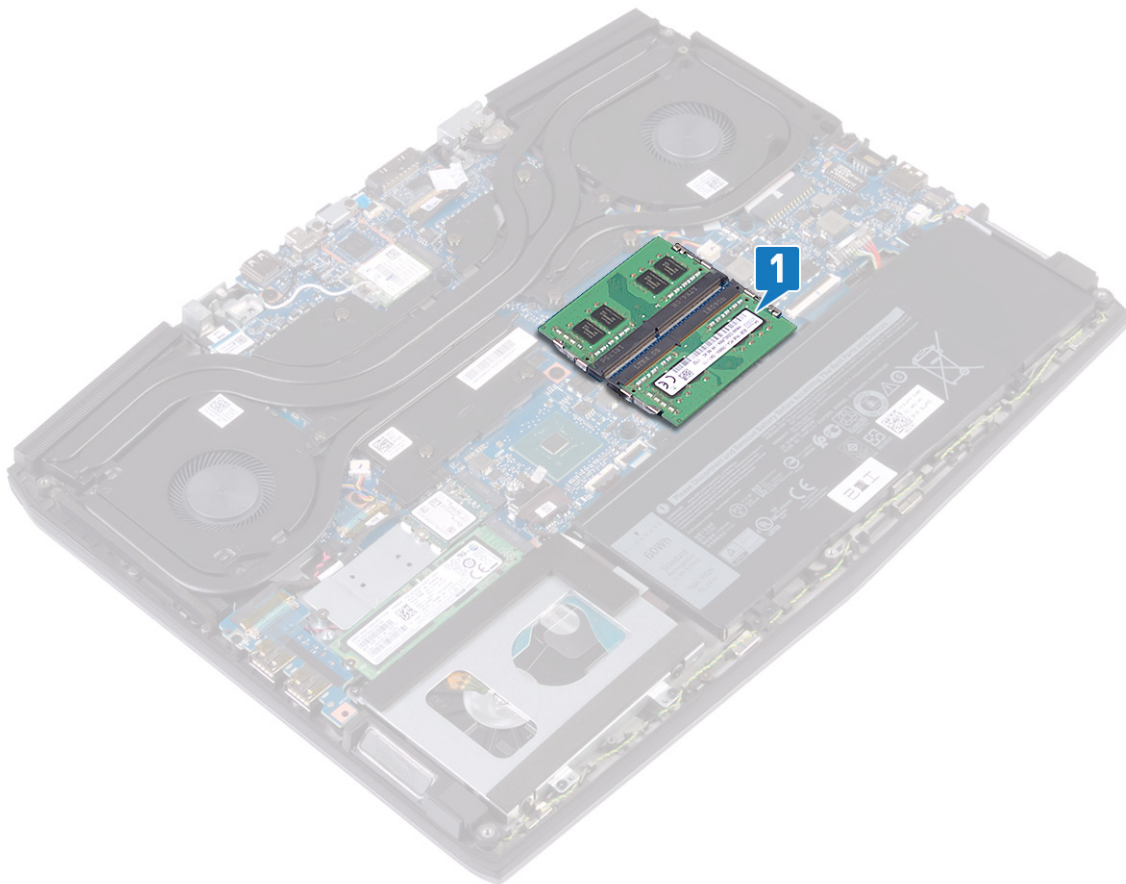

- 2 Use your fingertips to carefully spread apart the securing-clips on each end of the memory-module slot until the memory module pops up.

3 Remove the memory modules from the memory-module slot.

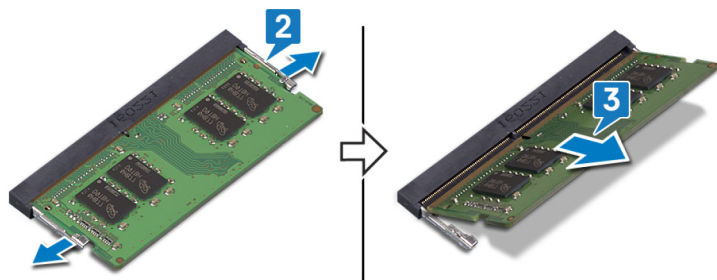

Replacing the memory modules

WARNING: Before working inside your computer, read the safety information that shipped with your computer and follow the steps in [Before working inside your computer](#). After working inside your computer, follow the instructions in [After working inside your computer](#). For more safety best practices, see the Regulatory Compliance home page at www.dell.com/regulatory_compliance.

Procedure

- 1 Align the notch on the memory module with the tab on the memory-module slot.
- 2 Slide the memory modules firmly into the slot at an angle.
- 3 Press the memory module down until it clicks into place.

NOTE: If you do not hear the click, remove the memory module and reinstall it.

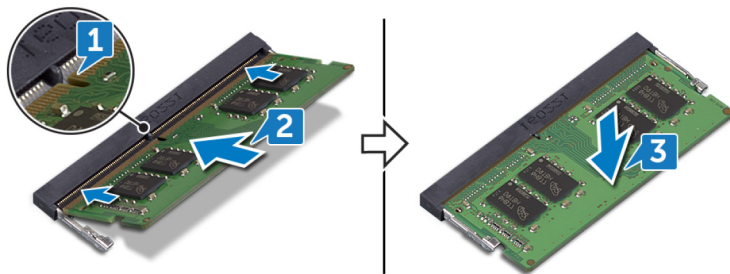

Post-requisites

Replace the [base cover](#).

Removing the heat sink

 **WARNING:** Before working inside your computer, read the safety information that shipped with your computer and follow the steps in [Before working inside your computer](#). After working inside your computer, follow the instructions in [After working inside your computer](#). For more safety best practices, see the Regulatory Compliance home page at www.dell.com/regulatory_compliance.

 **WARNING:** The heat sink may become hot during normal operation. Allow sufficient time for the heat sink to cool before you touch it.

 **CAUTION:** For maximum cooling of the processor, do not touch the heat transfer areas on the heat sink. The oils in your skin can reduce the heat transfer capability of the thermal grease.

Prerequisites

Remove the [base cover](#).

Procedure

- 1 Disconnect the left fan cable from the system board.
- 2 Disconnect the right fan cable from the system board.
- 3 Remove the five screws (M2x3) that secure the heat-sink assembly to the system board.
- 4 Remove the screw (M2x5) that secure the heat-sink assembly to the system board.
- 5 In the reverse sequential order (7>6>5>4>3>2>1), loosen the seven captive screws that secure the heat-sink assembly to the system board.

6 Lift the heat-sink assembly off the system board.

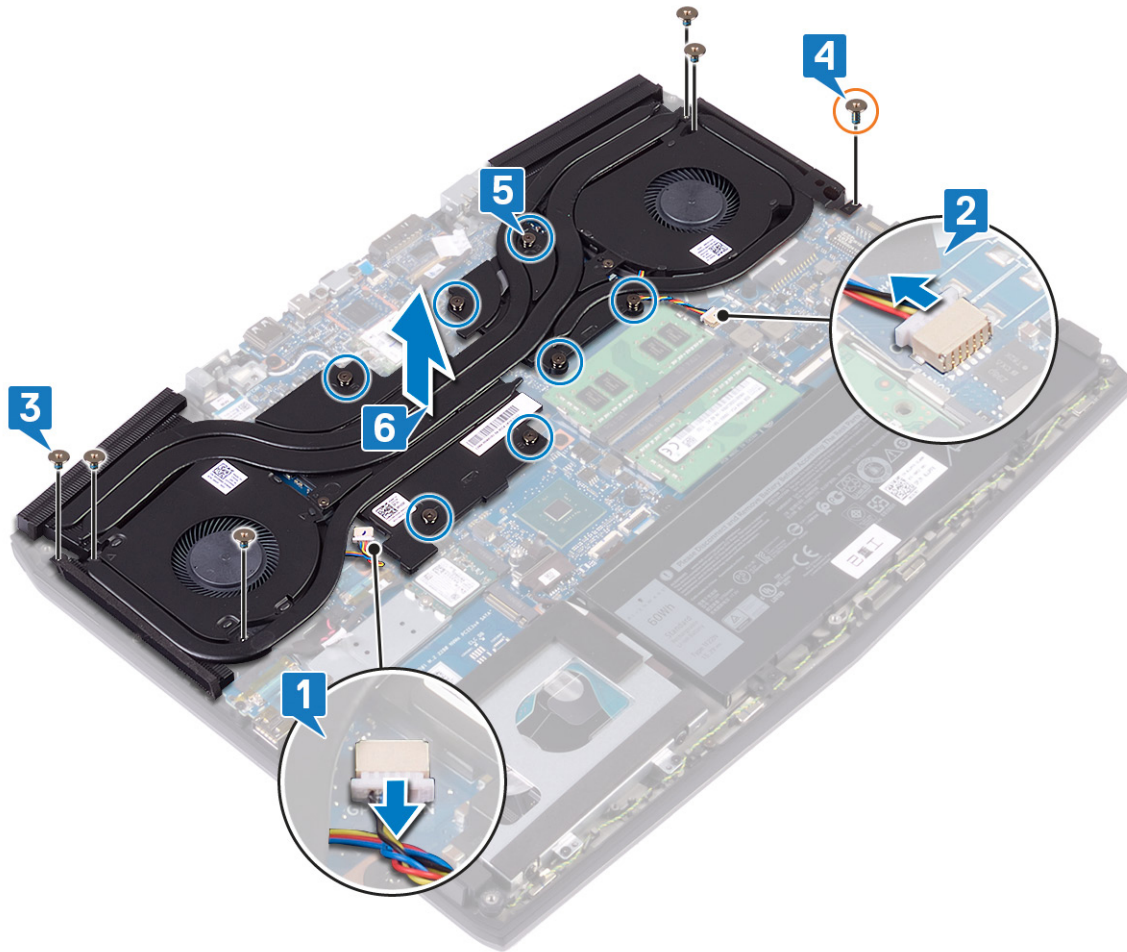

7 Remove the [fans](#).

Replacing the heat sink

 **WARNING:** Before working inside your computer, read the safety information that shipped with your computer and follow the steps in [Before working inside your computer](#). After working inside your computer, follow the instructions in [After working inside your computer](#). For more safety best practices, see the Regulatory Compliance home page at www.dell.com/regulatory_compliance.

 **CAUTION:** Incorrect alignment of the heat sink can damage the system board and processor.

 **NOTE:** If either the system board or the heat sink is replaced, use the thermal pad/paste provided in the kit to ensure that thermal conductivity is achieved.

Procedure

- 1 Replace the [fans](#).
- 2 Place the heat-sink assembly on the system board and align the screw holes on the heat-sink assembly with the screw holes on the system board.
- 3 Tighten the captive screws in the sequential order (1>2>3>4>5>6>7) to secure the heat-sink assembly to the system board.
- 4 Replace the screw (M2x5) that secure the heat-sink assembly to the system board.
- 5 Replace the five screws (M2x3) that secure the heat-sink assembly to the system board.
- 6 Connect the left fan cable to the system board.

7 Connect the right fan cable to the system board.

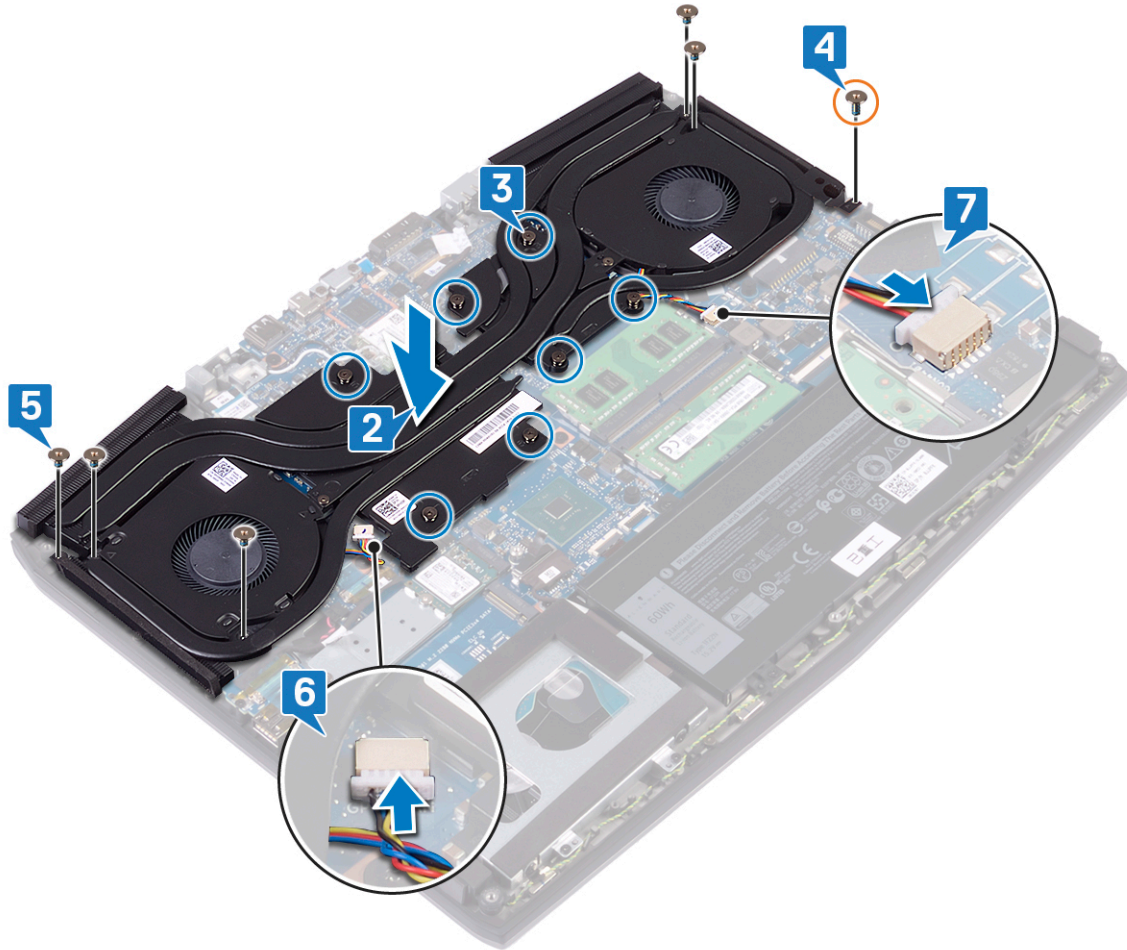

Post-requisites

Replace the [base cover](#).

Removing the fans

⚠ WARNING: Before working inside your computer, read the safety information that shipped with your computer and follow the steps in [Before working inside your computer](#). After working inside your computer, follow the instructions in [After working inside your computer](#). For more safety best practices, see the Regulatory Compliance home page at www.dell.com/regulatory_compliance.

Prerequisites

- 1 Remove the [base cover](#).
- 2 Follow the procedure from step 1 to step 6 in [Removing the heat sink](#).

Procedure

- 1 Remove the two screws (M2x3) that secure the fans to the heat sink.
- 2 Peel the tape securing the left fan to the heat sink.

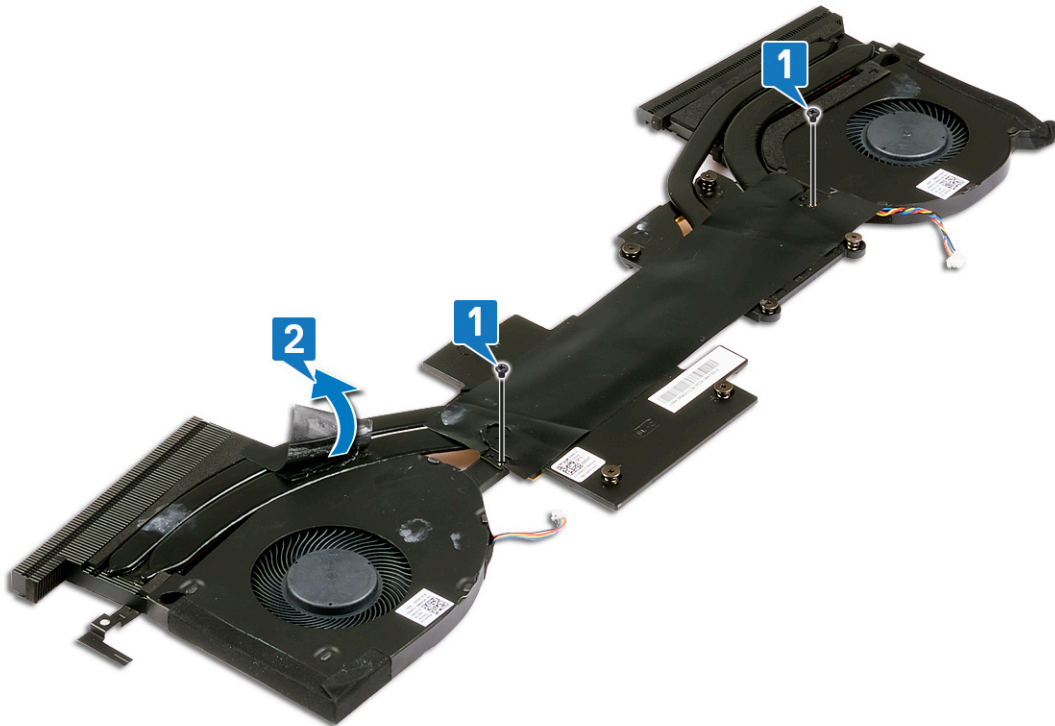

- 3 Turn the heat-sink assembly over.
- 4 Peel the Mylar securing the fans to the heat sink.

5 Lift the fans off the heat sink.

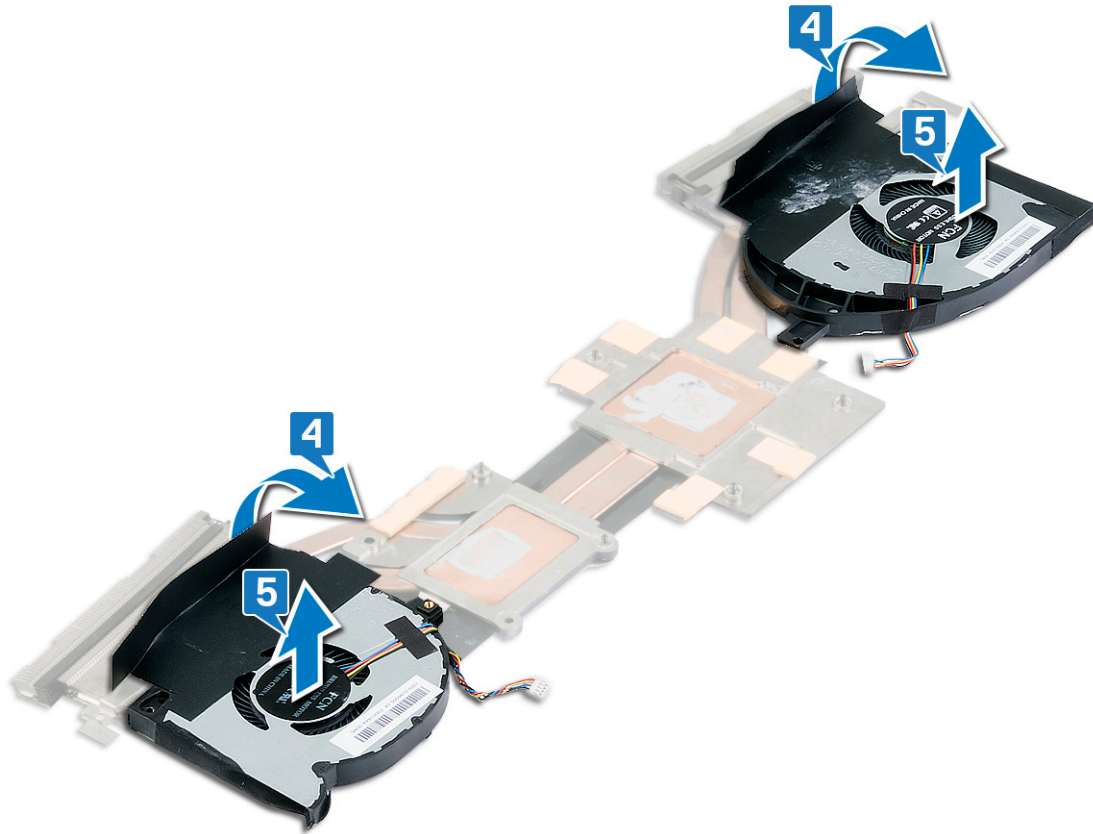

Replacing the fans

WARNING: Before working inside your computer, read the safety information that shipped with your computer and follow the steps in [Before working inside your computer](#). After working inside your computer, follow the instructions in [After working inside your computer](#). For more safety best practices, see the Regulatory Compliance home page at www.dell.com/regulatory_compliance.

Procedure

- 1 Place the fans on the heat sink and align the screw holes on the fans to the screw holes on the heat sink.
- 2 Adhere the Mylar that secures the fans to the heat sink.

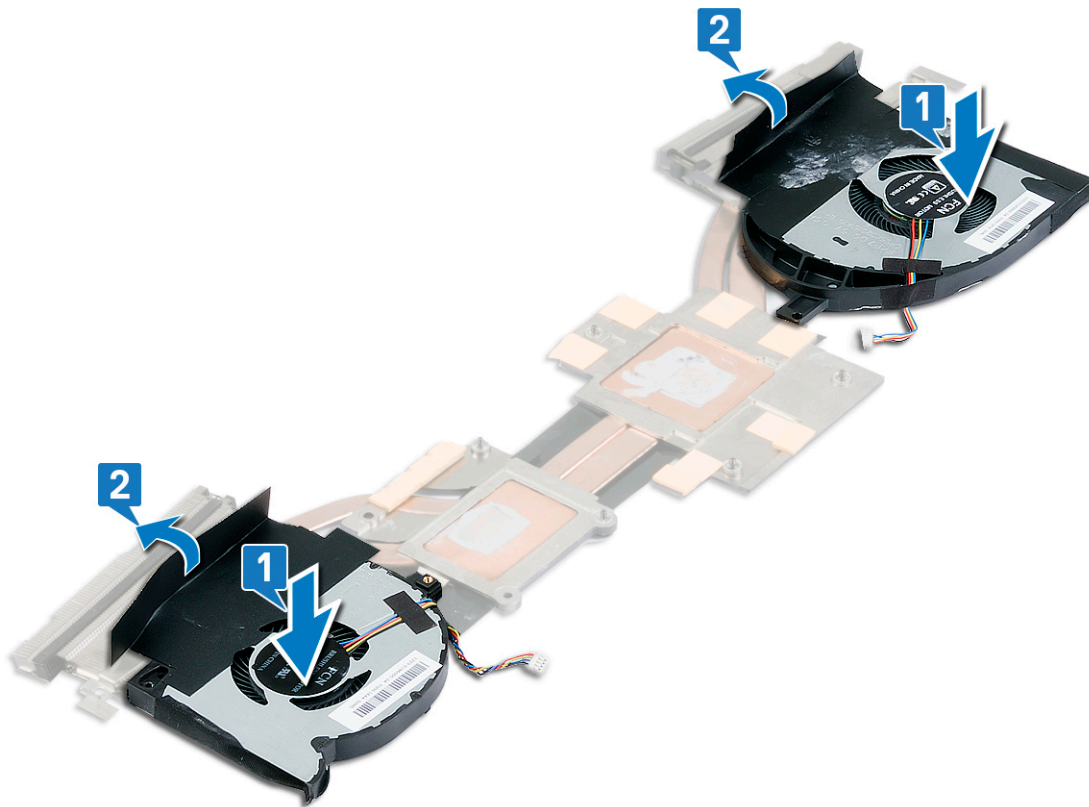

- 3 Turn over the heat-sink assembly.
- 4 Adhere the Mylar that secures the fan to the heat sink.

- 5 Replace the two screws (M2x3) that secure the fan to the heat sink.

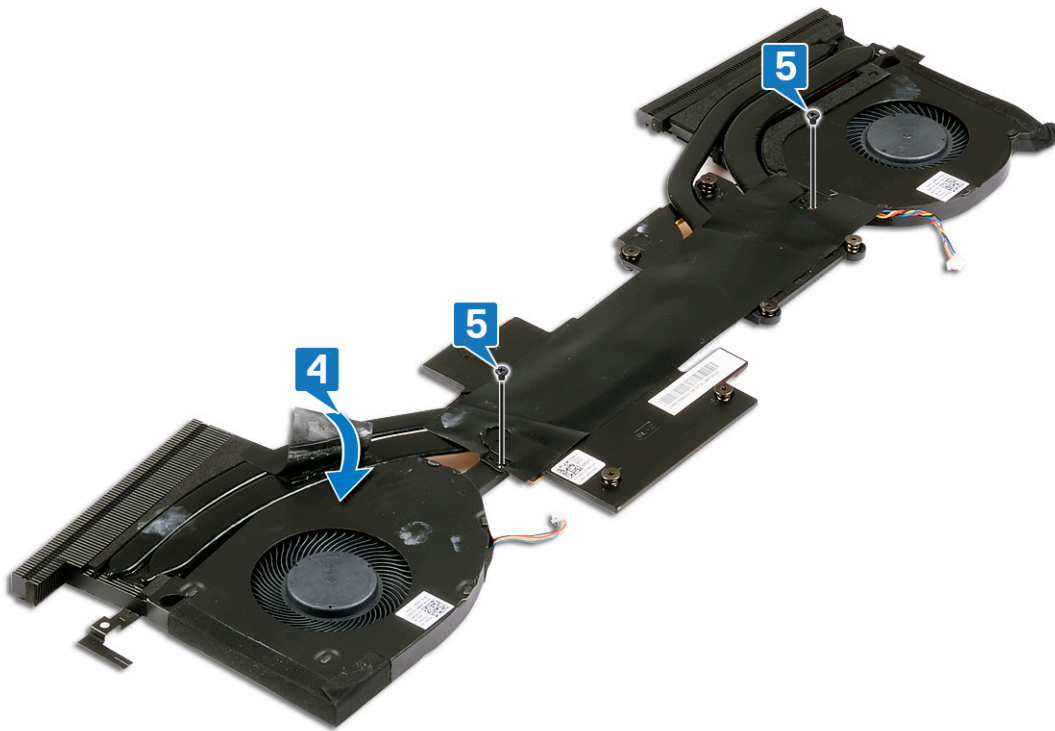

Post-requisites

- 1 Replace the [heat sink](#).
- 2 Replace the [base cover](#).

Removing the wireless card

WARNING: Before working inside your computer, read the safety information that shipped with your computer and follow the steps in [Before working inside your computer](#). After working inside your computer, follow the instructions in [After working inside your computer](#). For more safety best practices, see the Regulatory Compliance home page at www.dell.com/regulatory_compliance.

Prerequisites

Remove the [base cover](#).

Procedure

- 1 Locate the wireless card on your computer.

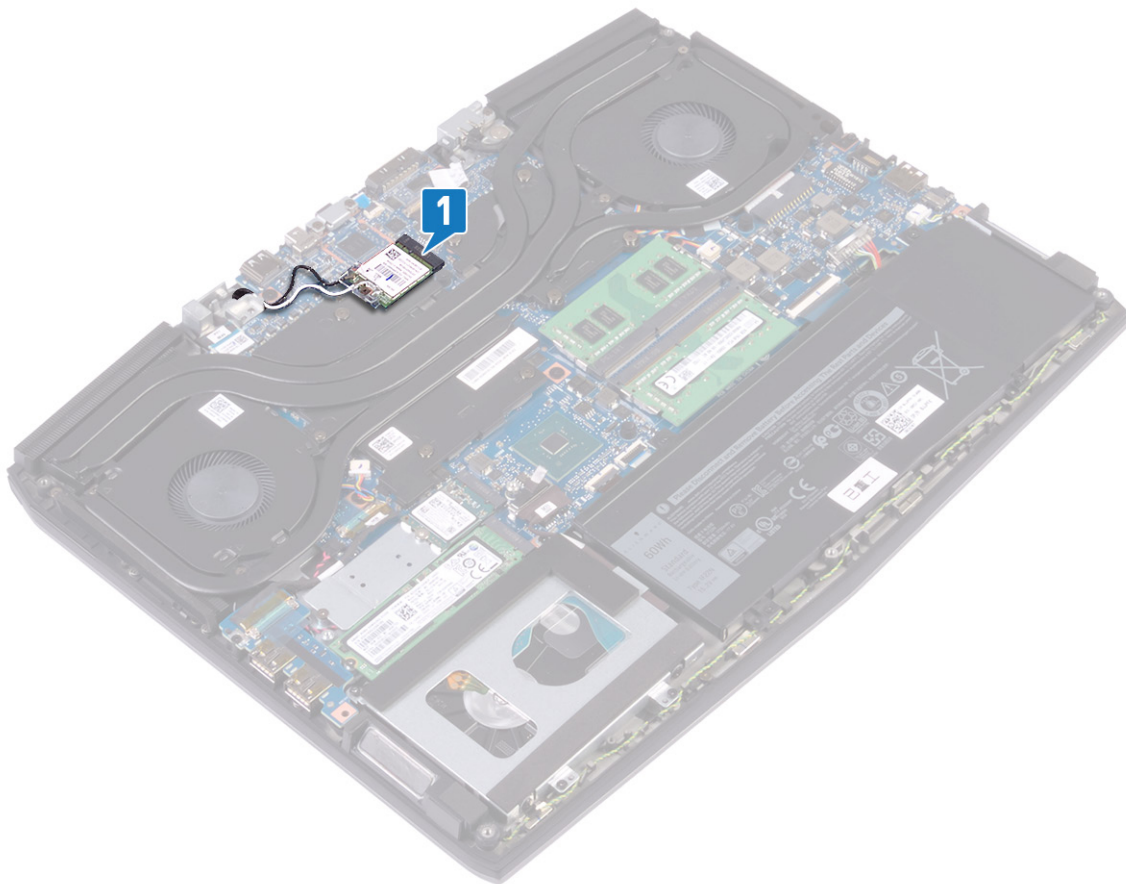

- 2 Remove the screw (M2x3) that secures the wireless-card bracket to the system board.
- 3 Slide and remove the wireless-card bracket from the wireless card.
- 4 Slide and remove the wireless card from the wireless-card slot.

5 Disconnect the antenna cables from the wireless card.

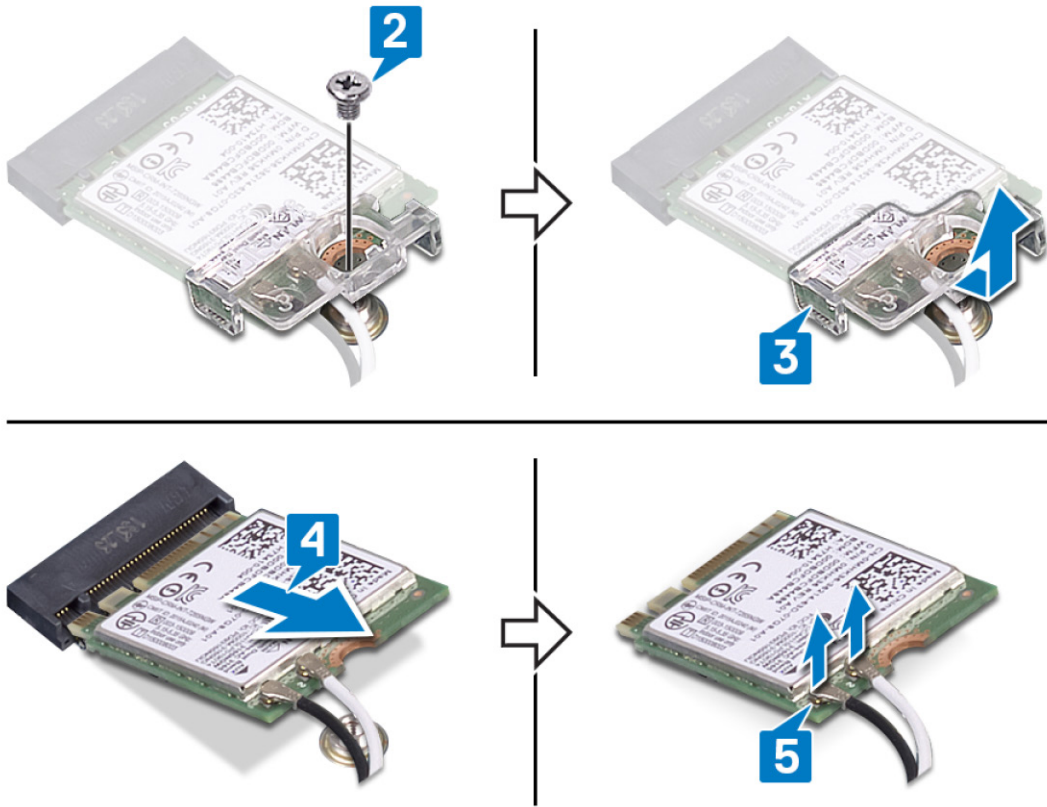

Replacing the wireless card

WARNING: Before working inside your computer, read the safety information that shipped with your computer and follow the steps in [Before working inside your computer](#). After working inside your computer, follow the instructions in [After working inside your computer](#). For more safety best practices, see the Regulatory Compliance home page at www.dell.com/regulatory_compliance.

Procedure

CAUTION: To avoid damage to the wireless card, do not place any cables under it.

- 1 Connect the antenna cables to the wireless card.

The following table provides the antenna-cable color scheme for the wireless card supported by your computer.

Table 2. Antenna-cable color scheme

Connectors on the wireless card	Antenna-cable color
Main (white triangle)	White
Auxiliary (black triangle)	Black

- 2 Slide and replace the wireless-card bracket on the wireless-card.
- 3 Align the notch on the wireless card with the tab on the wireless-card slot and insert the wireless card at an angle into the wireless-card slot.
- 4 Replace the screw (M2x3) that secures the wireless-card bracket to the wireless card and the palm rest and keyboard assembly.

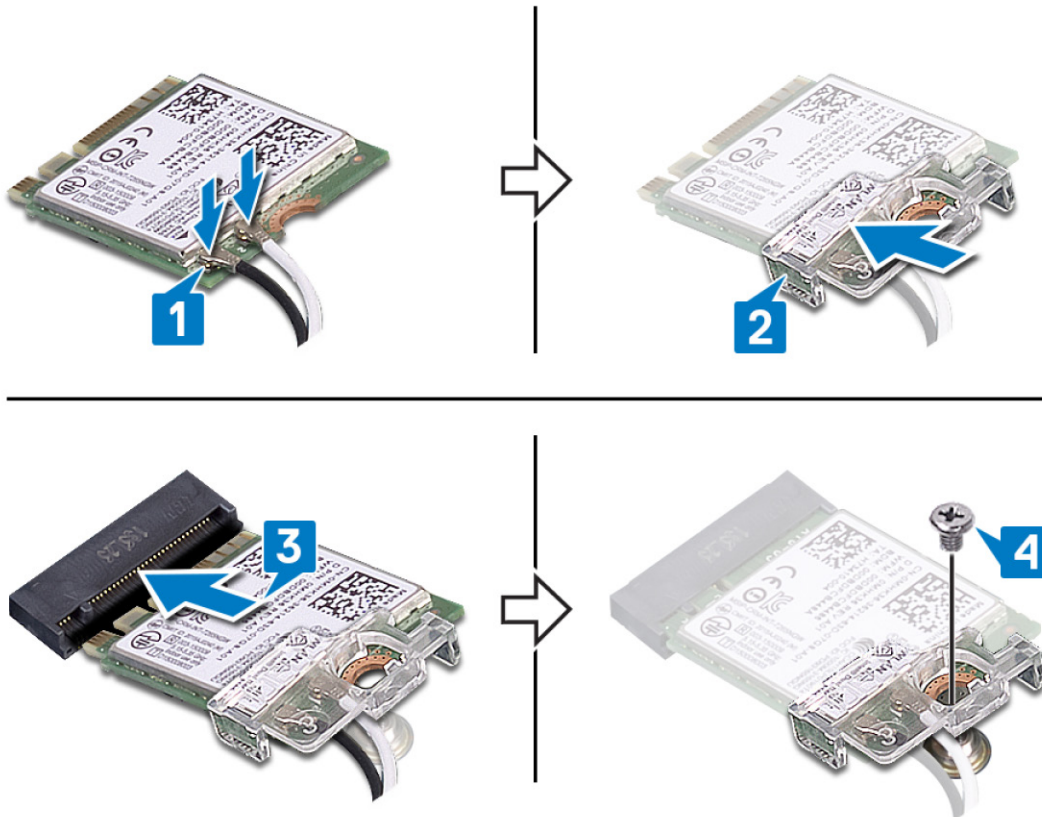

- 5 Route the antenna cables on to the securing clips on the system board.

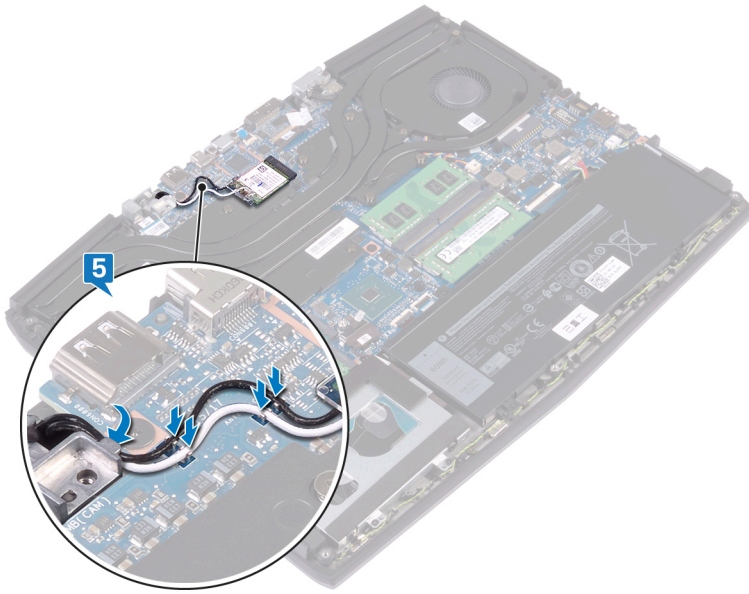

Post-requisites

Replace the [base cover](#).

Removing the solid-state drive/Intel Optane memory module

You need to disable the Intel Optane memory before removing Intel Optane memory module from your computer. For more information about disabling the Intel Optane memory, see [Disabling Intel Optane memory](#).

WARNING: Before working inside your computer, read the safety information that shipped with your computer and follow the steps in [Before working inside your computer](#). After working inside your computer, follow the instructions in [After working inside your computer](#). For more safety best practices, see the Regulatory Compliance home page at www.dell.com/regulatory_compliance.

Prerequisites

Remove the [base cover](#).

Procedure to remove M.2 2230 solid-state drive

- NOTE:** This procedure applies only to systems shipped with a M.2 2230 solid-state drive installed.
 - NOTE:** Depending on the configuration ordered the system may have up to two M.2 solid-state drives installed. Supported solid-state drive configurations per M.2 card slot:
 - M.2 2230 solid-state drive + solid-state drive bracket
 - M.2 2280 solid-state drive
 - M.2 2280 Intel Optane
 - NOTE:** For solid-state drives above 512 GB or Intel Optane above 118 GB a thermal shield is required for optimal heat dissipation and is installed in the computer when these configurations are ordered. If these configurations are installed After Point-of-Sale (APOS), contact Dell support for the thermal shield.
 - NOTE:** Depending on the number of M.2 solid-state drives installed at Point-of-Sale, the thermal shield installed in the computer may be a full shield or a half shield. If two M.2 solid-state drives are installed After Point-of-Sale (APOS) contact Dell support for the full thermal shield.
- 1 Remove the two screws (M2x3) that secure the M.2 thermal shield to the palm-rest assembly and system board.
 - 2 Lift the M.2 thermal shield from the palm-rest assembly and system board.

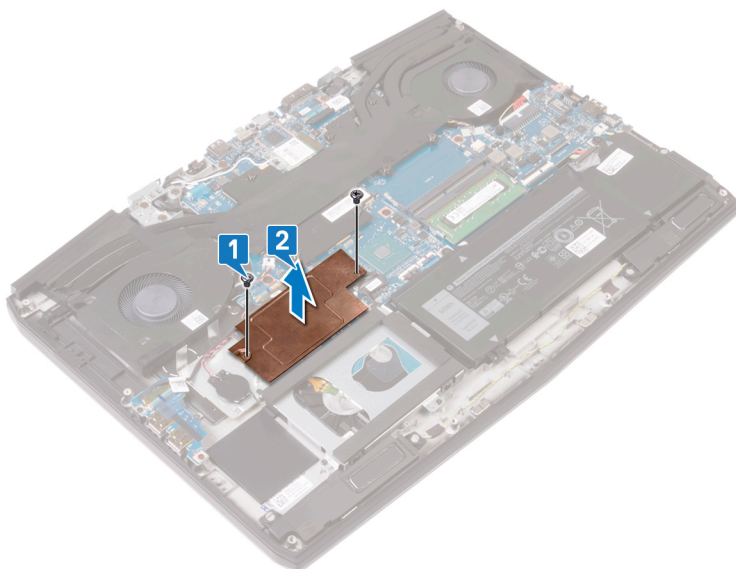

- 3 Remove the screw (M2x3) that secures the M.2 2230 solid-state drive bracket to the palm-rest assembly.
- 4 Slide and remove the M.2 2230 solid-state drive along with the bracket from the M.2 slot on the system board.
- 5 Remove the screw (M1.6x2) that secures M.2 2230 solid-state drive to the solid-state drive bracket.
- 6 Lift the M.2 2230 card off the solid-state drive bracket.

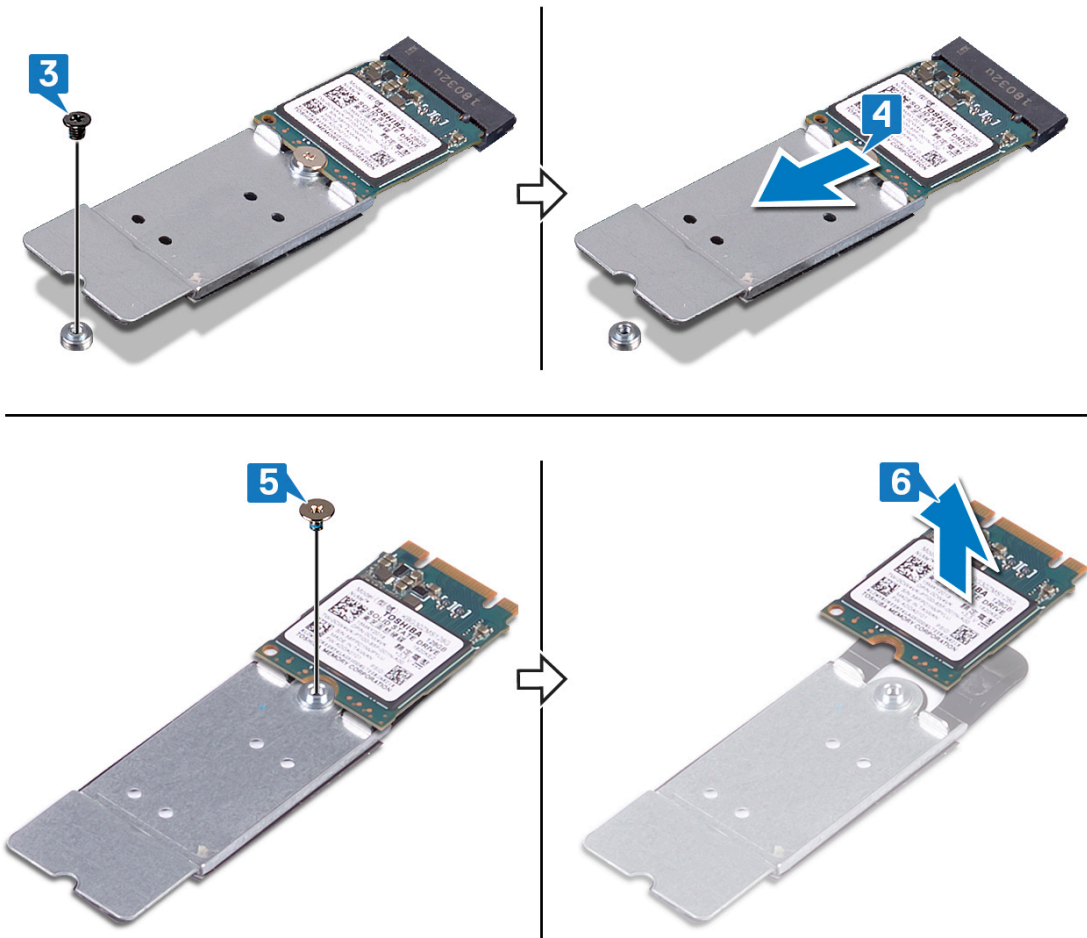

Procedure to remove M.2 2280 solid-state drive

- NOTE: This procedure applies only to systems shipped with a M.2 2280 solid-state drive installed.
 - NOTE: Depending on the configuration ordered the system may have up to two M.2 solid-state drives installed. Supported solid-state drive configurations per M.2 solid-state drive slot:
 - M.2 2230 solid-state drive + solid-state drive bracket
 - M.2 2280 solid-state drive
 - M.2 2280 Intel Optane
 - NOTE: For solid-state drives above 512 GB or Intel Optane above 118 GB a thermal shield is required for optimal heat dissipation and is installed in the computer when these configurations are ordered. If these configurations are installed After Point-of-Sale (APOS), contact Dell support for the thermal shield.
 - NOTE: Depending on the number of M.2 solid-state drives installed at Point-of-Sale, the thermal shield installed in the computer may be a full shield or a half shield. If two M.2 solid-state drives are installed After Point-of-Sale (APOS) contact Dell support for the full thermal shield.
- 1 Remove the two screws (M2x3) that secure the M.2 thermal shield to the palm-rest assembly and system board.

- 2 Lift the M.2 thermal shield from the palm-rest assembly and system board.

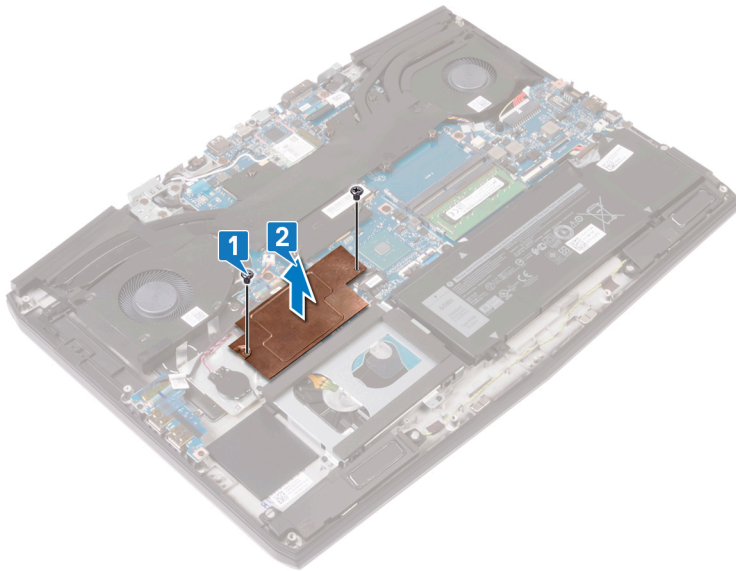

- 3 Remove the screw (M2x2) that secures the M.2 2280 card to the palm-rest assembly.
- 4 Slide and remove the M.2 2280 card from the M.2 card slot on the system board.

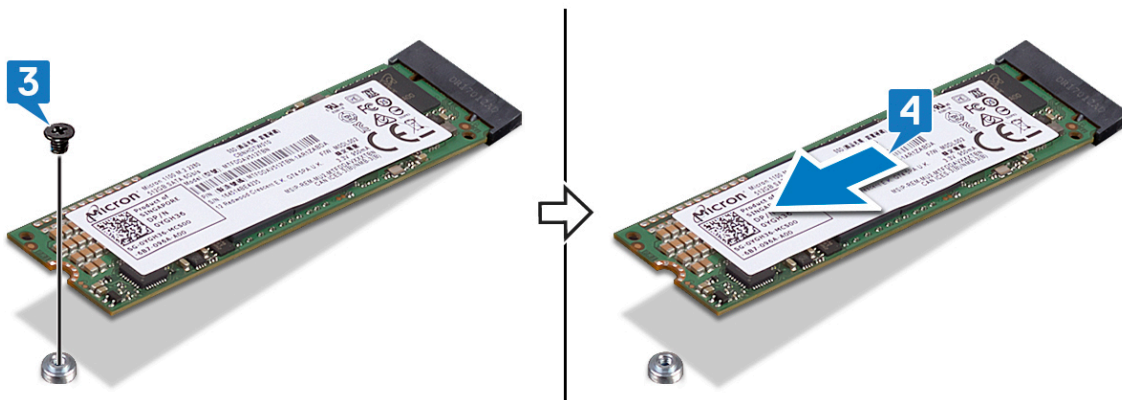

Replacing the solid-state drive/Intel Optane memory module

Enable the Intel Optane memory after you replace the Intel Optane memory module. For more information about enabling the Intel Optane memory, see [Enabling Intel Optane memory](#).

 **WARNING:** Before working inside your computer, read the safety information that shipped with your computer and follow the steps in [Before working inside your computer](#). After working inside your computer, follow the instructions in [After working inside your computer](#). For more safety best practices, see the Regulatory Compliance home page at www.dell.com/regulatory_compliance.

 **CAUTION:** Solid-state drives are fragile. Exercise care when handling the solid-state drive.

Procedure to replace M.2 2230 solid-state drive

 **NOTE:** This procedure applies only to systems shipped with a M.2 2230 solid-state drive installed.

 **NOTE:** Depending on the configuration ordered the system may have up to two M.2 solid-state drives installed. Supported card configurations per M.2 solid-state drive slot:

- M.2 2230 solid-state drive + solid-state drive bracket
- M.2 2280 solid-state drive
- M.2 2280 Intel Optane

 **NOTE:** For solid-state drives above 512 GB or Intel Optane above 118 GB a thermal shield is required for optimal heat dissipation and is installed in the computer when these configurations are ordered. If these configurations are installed After Point-of-Sale (APOS), contact Dell support for the thermal shield.

 **NOTE:** Depending on the number of M.2 solid-state drives installed at Point-of-Sale, the thermal shield installed in the computer may be a full shield or a half shield. If two M.2 solid-state drives are installed After Point-of-Sale (APOS) contact Dell support for the full thermal shield.

- 1 Place the M.2 2230 solid-state drive on the M.2 2230 solid-state drive bracket.
- 2 Replace the screw (M1.6x2) that secures the M.2 2230 solid-state drive to the M.2 2230 solid-state drive bracket.
- 3 Align the notch on the M.2 2230 solid-state drive with the tab on the M.2 solid-state drive slot on the system board.
- 4 Slide the M.2 2230 solid-state drive along with the bracket into the M.2 solid-state drive slot on the system board.

5 Replace the screw (M2x3) that secures the M.2 2230 bracket to the palm-rest assembly.

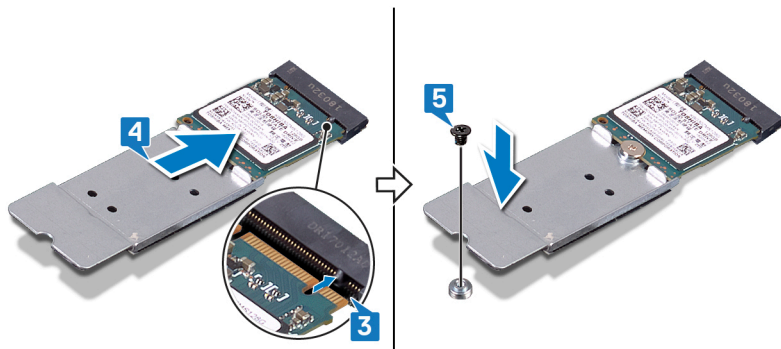
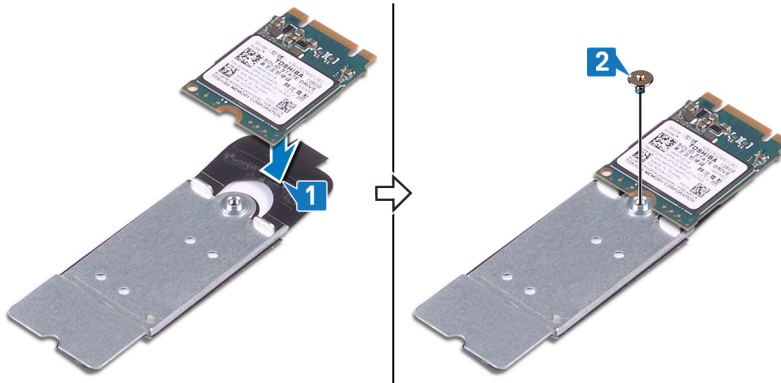

6 Align the screw holes of the M.2 thermal shield with the screw holes on the palm-rest assembly and system board.

- 7 Replace the two screws (M2x3) that secure the M.2 thermal shield to the palm-rest assembly and system board.

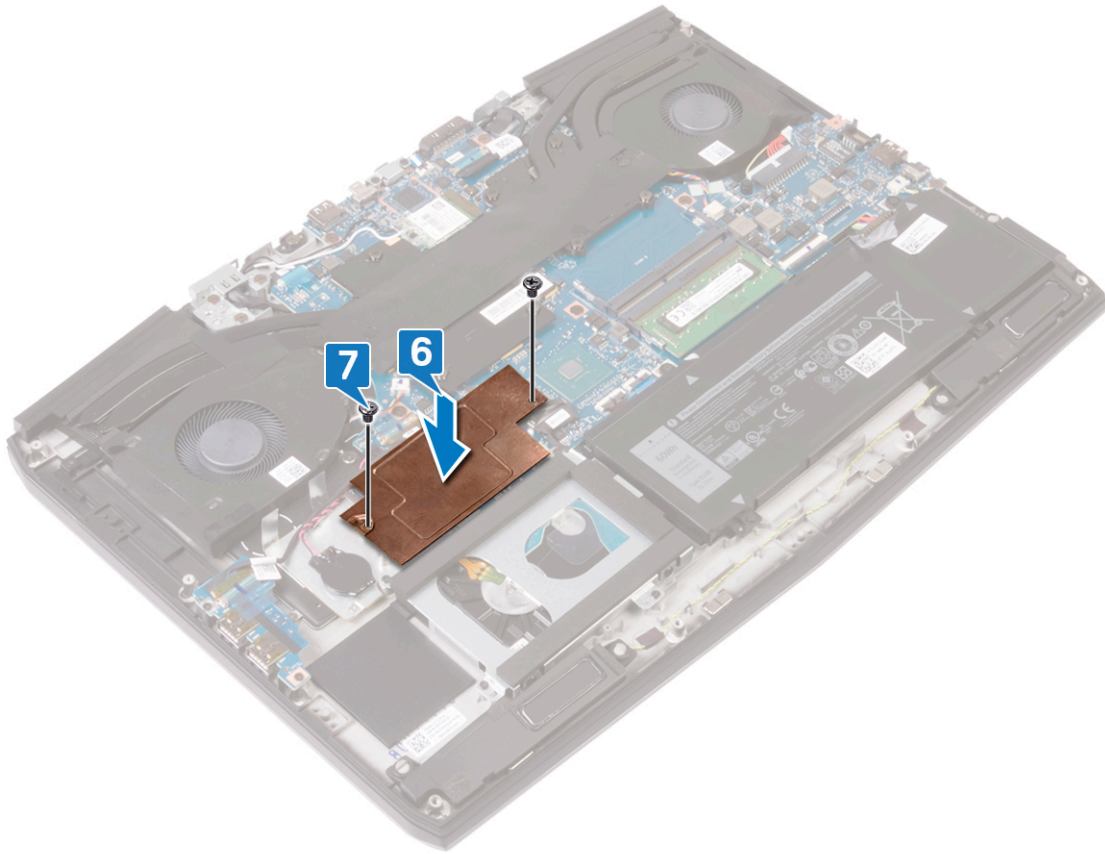

Procedure to replace M.2 2280 solid-state drive

- NOTE: This procedure applies only to systems shipped with a M.2 2280 solid-state drive installed.
 - NOTE: Depending on the configuration ordered the system may have up to two M.2 solid-state drives installed. Supported solid-state drive configurations per M.2 solid-state drive slot:
 - M.2 2230 solid-state drive + solid-state drive bracket
 - M.2 2280 solid-state drive
 - M.2 2280 Intel Optane
 - NOTE: For solid-state drives above 512 GB or Intel Optane above 118 GB a thermal shield is required for optimal heat dissipation and is installed in the computer when these configurations are ordered. If these configurations are installed After Point-of-Sale (APOS), contact Dell support for the thermal shield.
 - NOTE: Depending on the number of M.2 solid-state drives installed at Point-of-Sale, the thermal shield installed in the computer may be a full shield or a half shield. If two M.2 solid-state drives are installed After Point-of-Sale (APOS) contact Dell support for the full thermal shield.
- 1 Align the notch on the M.2 2280 solid-state drive with the tab on the M.2 solid-state drive slot on the system board.
 - 2 Slide the M.2 2280 solid-state drive into the M.2 solid-state drive slot on the system board.

- 3 Replace the screw (M2x3) that secures the M.2 2280 solid-state drive to the palm-rest assembly.

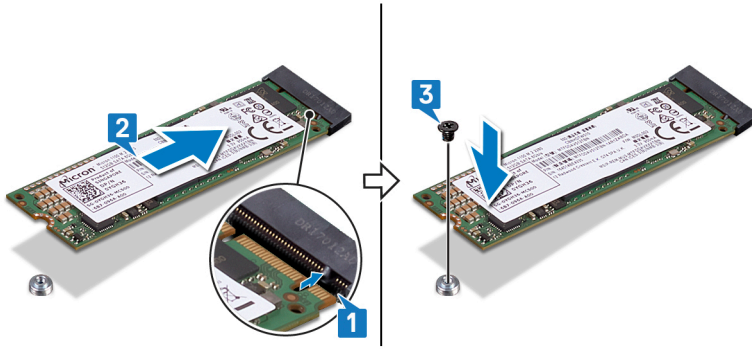

- 4 Align the screw holes of the M.2 thermal shield with the screw holes on the palm-rest assembly and system board.
- 5 Replace the two screws (M2x3) that secure the M.2 thermal shield to the palm-rest assembly and system board.

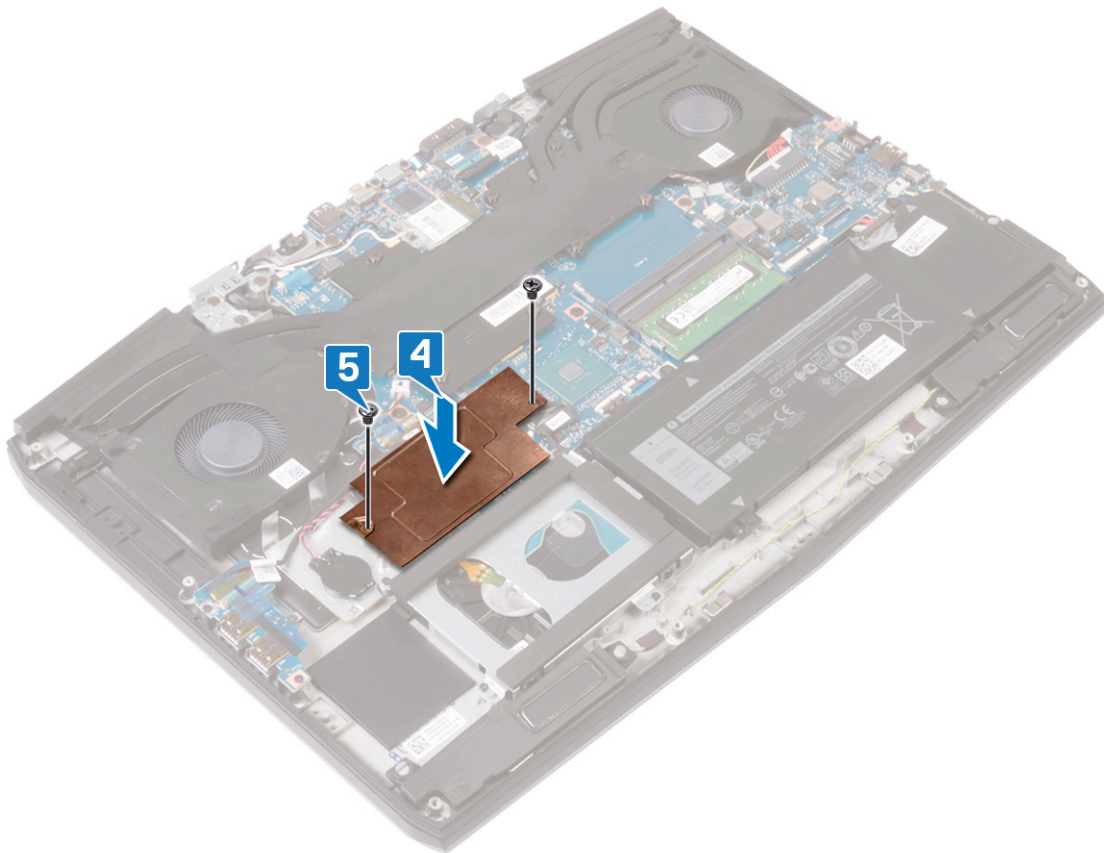

Post-requisites

Replace the [base cover](#).

Removing the I/O board

WARNING: Before working inside your computer, read the safety information that shipped with your computer and follow the steps in [Before working inside your computer](#). After working inside your computer, follow the instructions in [After working inside your computer](#). For more safety best practices, see the Regulatory Compliance home page at www.dell.com/regulatory_compliance.

Prerequisites

Remove the [base cover](#).

Procedure

- 1 Peel the tape that secures the I/O-board cable to the I/O board.
- 2 Open the latch and disconnect the I/O-board cable from the I/O board.

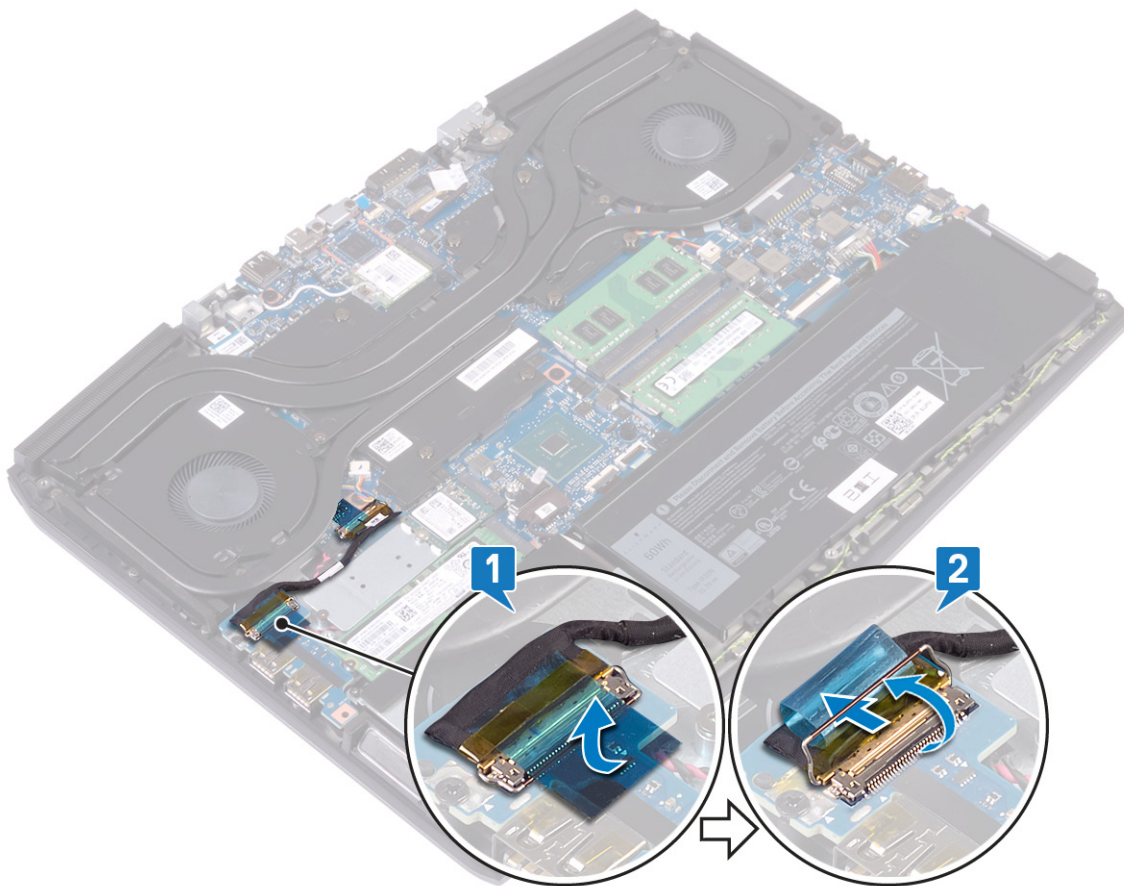

- 3 Remove the screw (M2x5) that secures the I/O board to the palm-rest assembly.

- 4 Lift the I/O board off the palm-rest assembly.

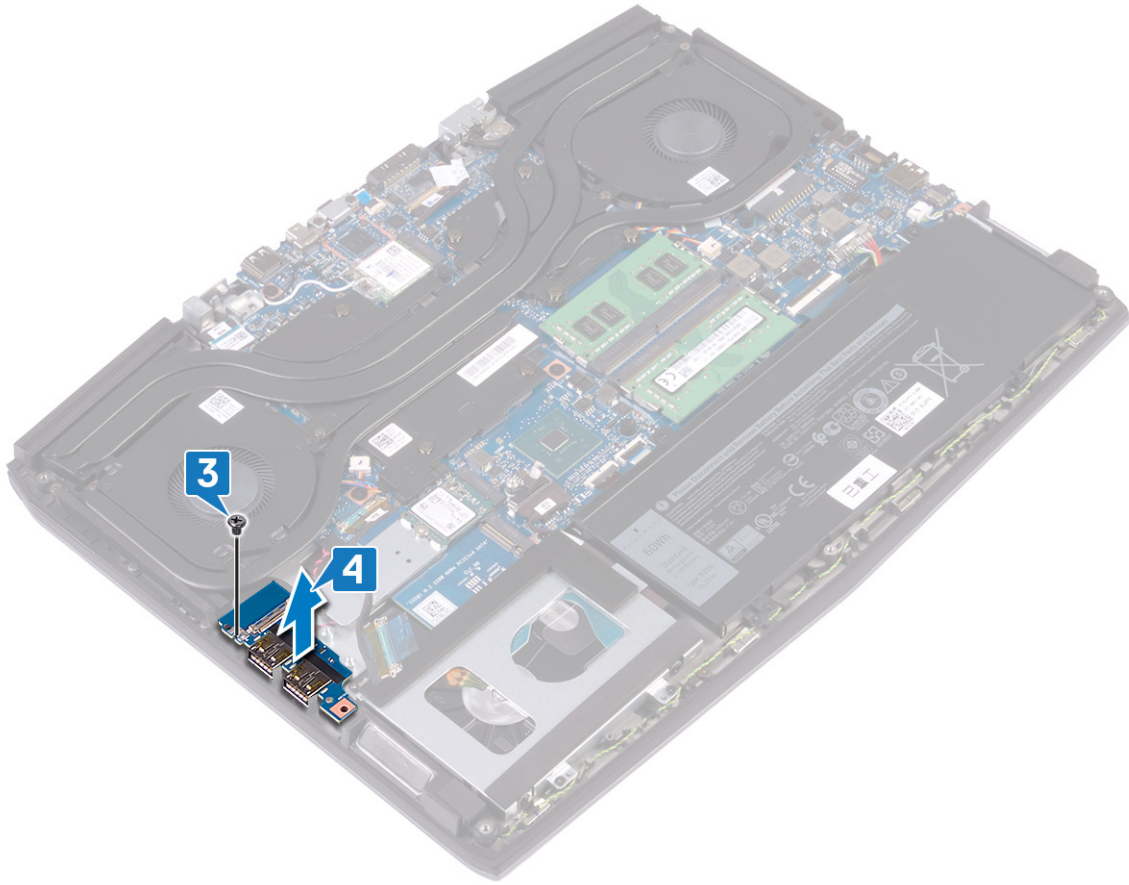

Replacing the I/O board

WARNING: Before working inside your computer, read the safety information that shipped with your computer and follow the steps in [Before working inside your computer](#). After working inside your computer, follow the instructions in [After working inside your computer](#). For more safety best practices, see the Regulatory Compliance home page at www.dell.com/regulatory_compliance.

Procedure

- 1 Align the USB ports on the I/O board with the slots on the palm-rest assembly.
- 2 Align the screw hole on the I/O board with the screw hole on the palm-rest assembly and replace the screw (M2x5) that secures the I/O board to the palm-rest assembly.

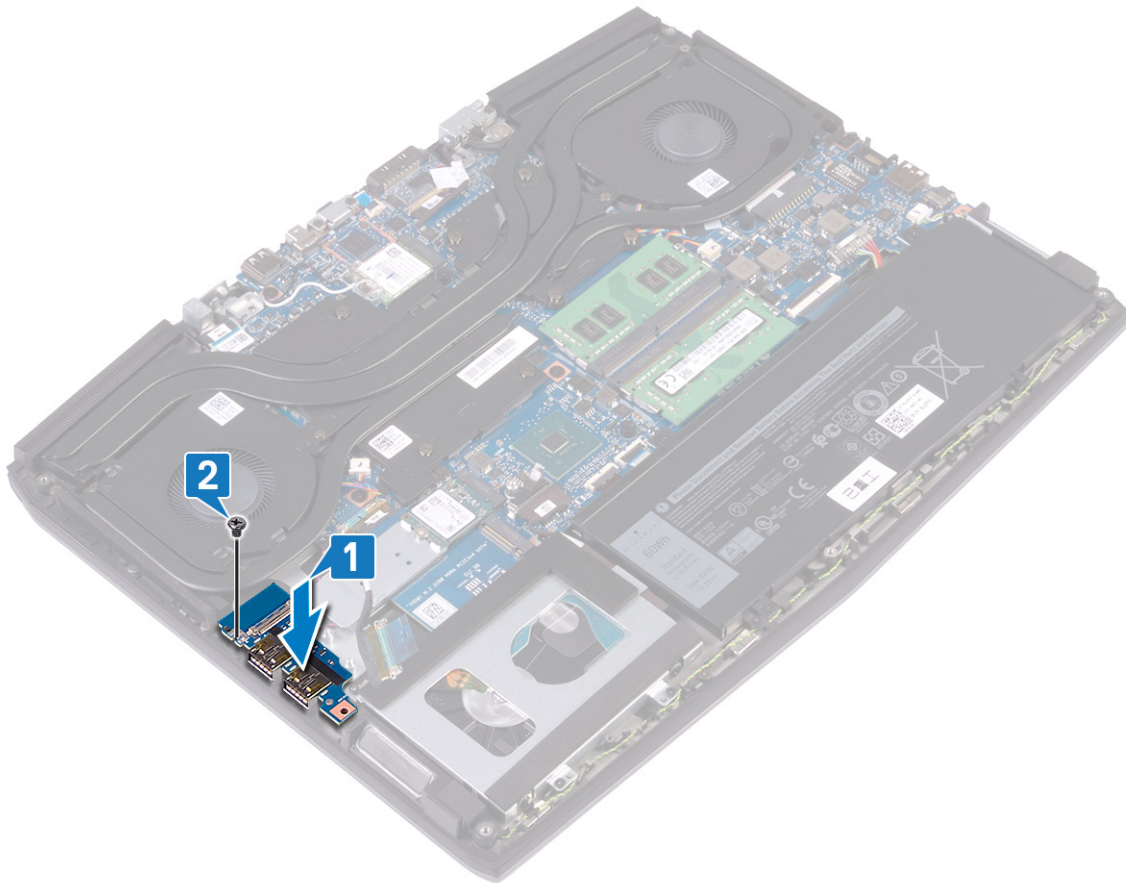

- 3 Connect the I/O-board cable to the connector on the I/O board and close the latch to secure the cable.

- 4 Adhere the tape that secures the I/O-board cable to the I/O board.

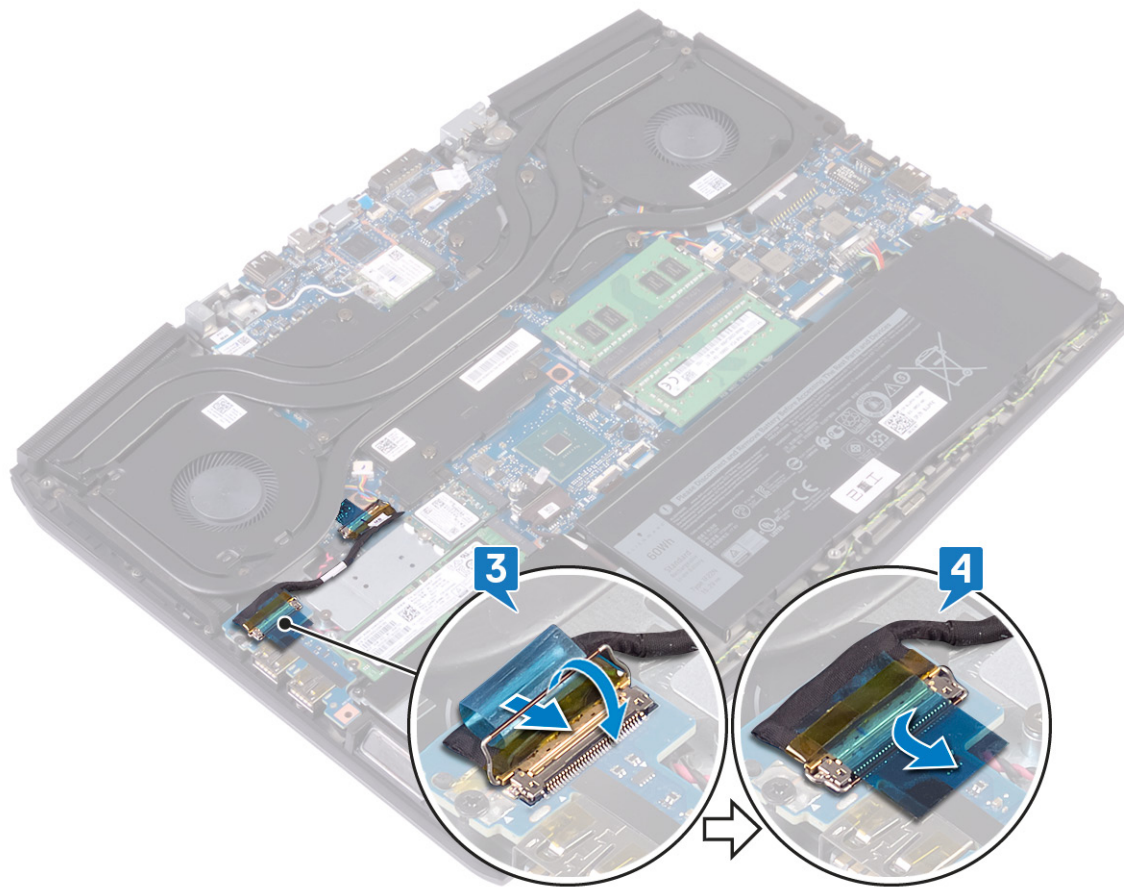

Post-requisites

Replace the [base cover](#).

Removing the coin-cell battery

WARNING: Before working inside your computer, read the safety information that shipped with your computer and follow the steps in [Before working inside your computer](#). After working inside your computer, follow the instructions in [After working inside your computer](#). For more safety best practices, see the Regulatory Compliance home page at www.dell.com/regulatory_compliance.

CAUTION: Removing the coin-cell battery resets the BIOS setup program's settings to default. It is recommended that you note the BIOS setup program's settings before removing the coin-cell battery.

Prerequisites

- 1 Remove the [base cover](#).
- 2 Remove the [solid-state drive/Intel Optane](#).
- 3 Remove the [I/O board](#).

Procedure

- 1 Disconnect the coin-cell battery from the system board.
- 2 Peel the tape that secures the coin-cell battery cable to the palm-rest assembly.
- 3 Peel the coin-cell battery off the palm-rest assembly.

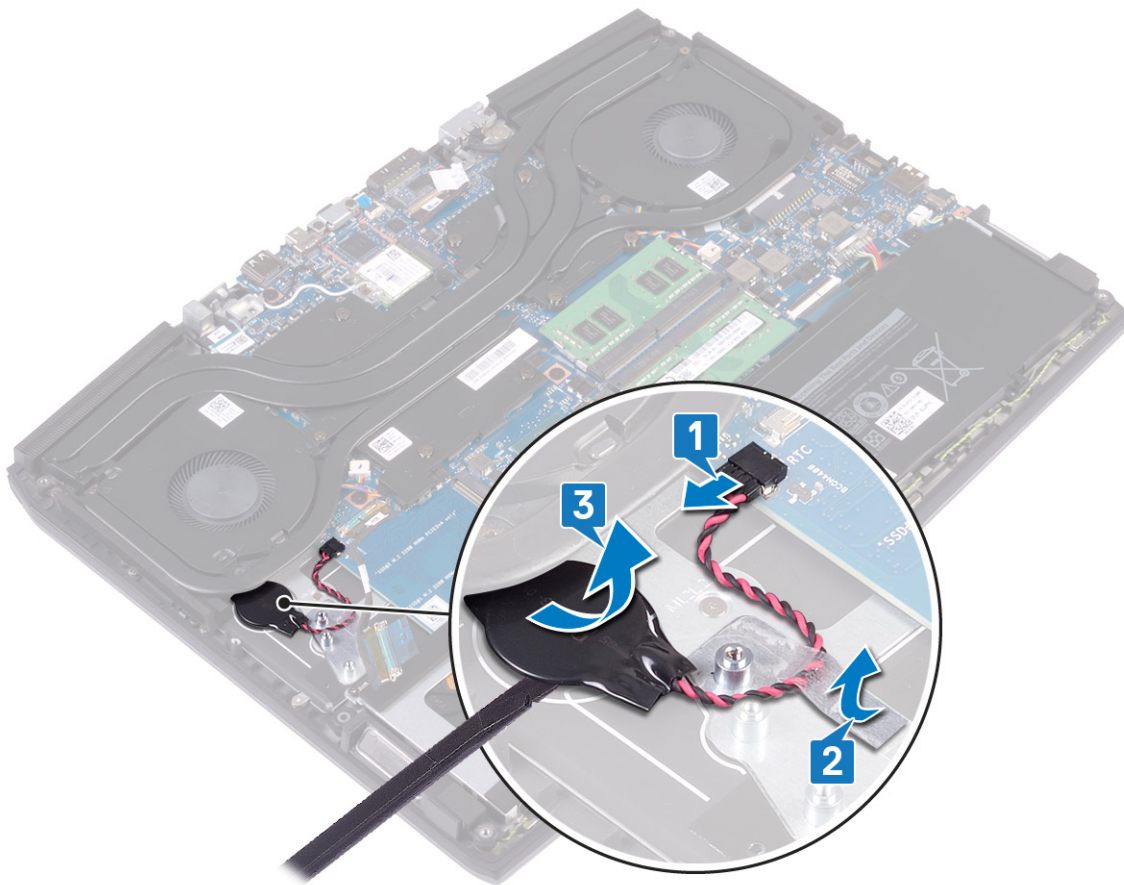

Replacing the coin-cell battery

WARNING: Before working inside your computer, read the safety information that shipped with your computer and follow the steps in [Before working inside your computer](#). After working inside your computer, follow the instructions in [After working inside your computer](#). For more safety best practices, see the Regulatory Compliance home page at www.dell.com/regulatory_compliance.

Procedure

- 1 Adhere the coin-cell battery to the palm-rest assembly.
- 2 Adhere the tape that secures the coin-cell battery to the palm-rest assembly.
- 3 Connect the battery cable to the system board.

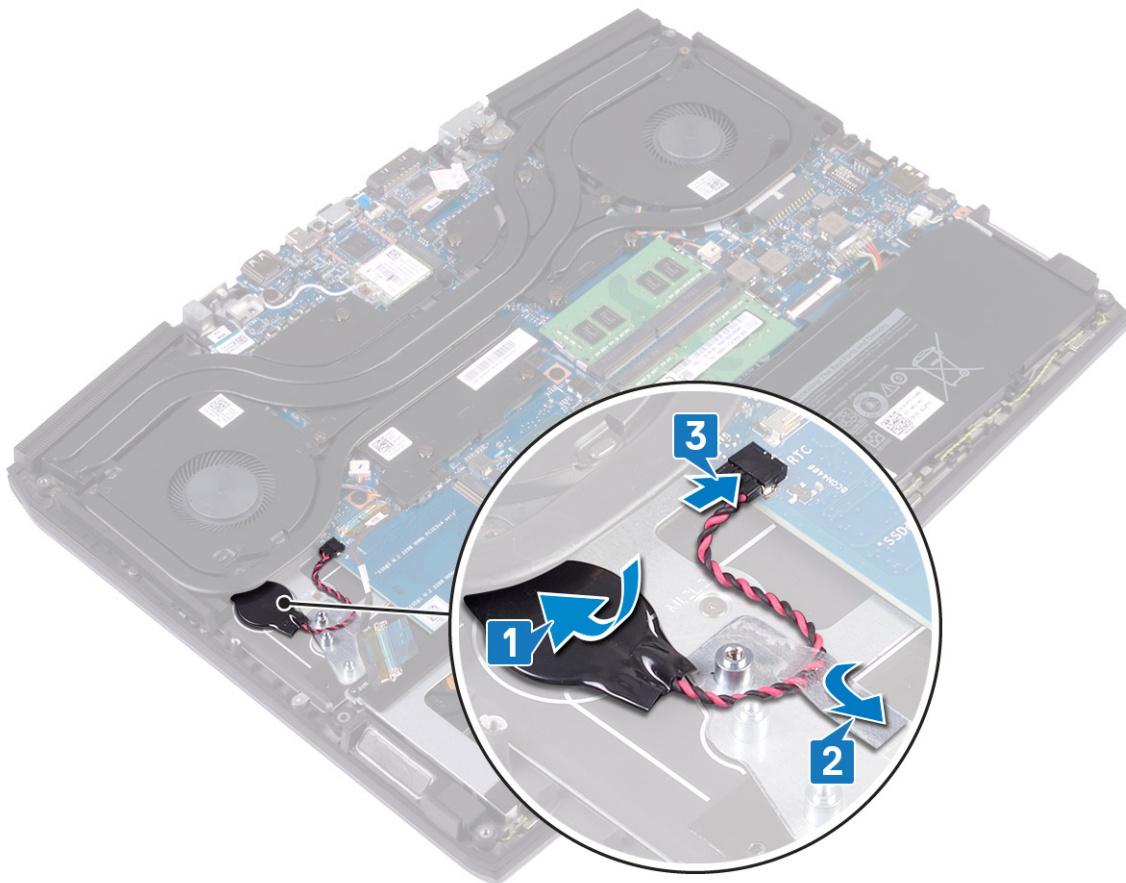

Post-requisites

- 1 Replace the [I/O board](#).
- 2 Replace the [solid-state drive/Intel Optane](#).
- 3 Replace the [base cover](#).

Removing the touchpad

WARNING: Before working inside your computer, read the safety information that shipped with your computer and follow the steps in [Before working inside your computer](#). After working inside your computer, follow the instructions in [After working inside your computer](#). For more safety best practices, see the Regulatory Compliance home page at www.dell.com/regulatory_compliance.

Prerequisites

- 1 Remove the [base cover](#).
- 2 Remove the [battery \(half-length\)](#) or the [battery \(full-length\)](#), whichever applicable.

Procedure

- 1 Open the latch and disconnect the touchpad cable from the system board.
- 2 Remove the four screws (M2x2.5) that secure the touchpad to the palm-rest assembly.
- 3 Slide the touchpad along with its cable at an angle and lift the touchpad off the palm-rest assembly.

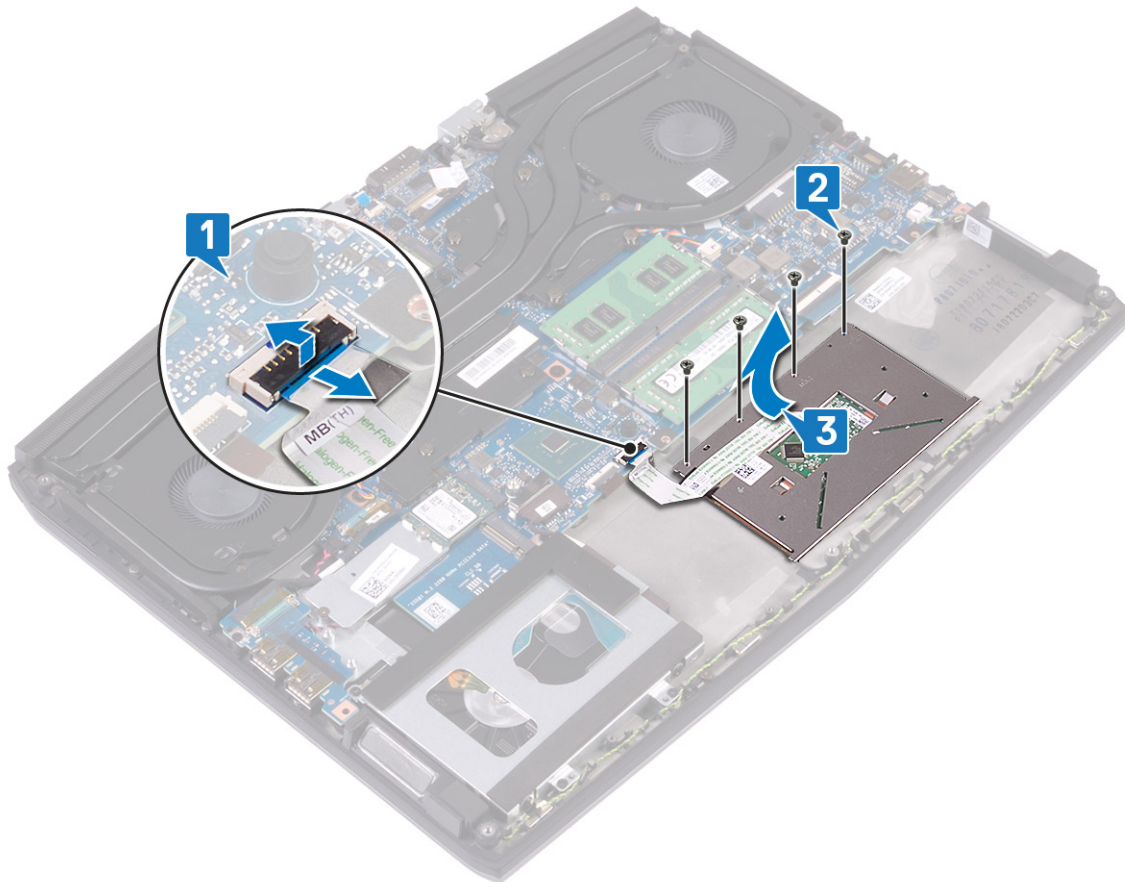

Replacing the touchpad

WARNING: Before working inside your computer, read the safety information that shipped with your computer and follow the steps in [Before working inside your computer](#). After working inside your computer, follow the instructions in [After working inside your computer](#). For more safety best practices, see the Regulatory Compliance home page at www.dell.com/regulatory_compliance.

Procedure

- 1 Slide and place the touchpad into the slot on the palm-rest assembly. Ensure that the touchpad is aligned with the guides available on the palm-rest assembly, and the gap on either sides of the touchpad is equal.

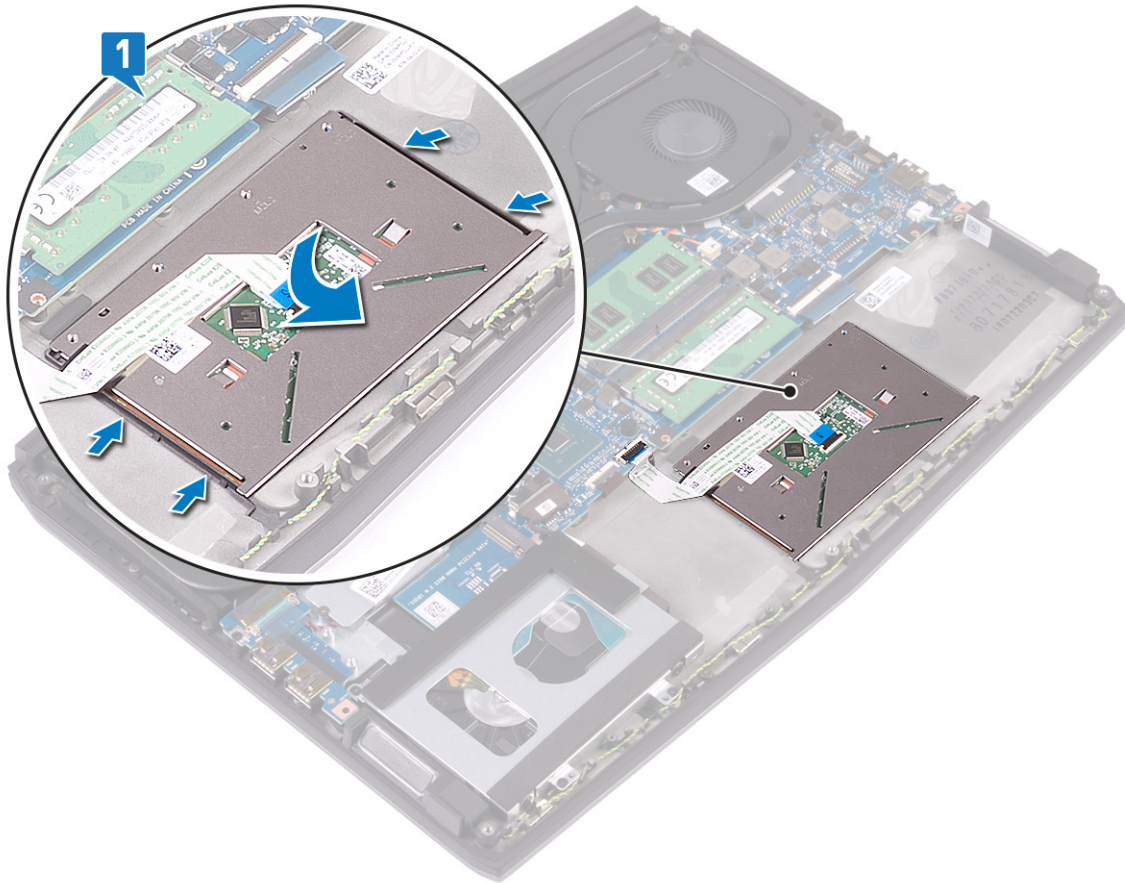

- 2 Replace the four screws (M2x2.5) that secure the touchpad to the palm-rest assembly.

NOTE: Turn the computer over and open the display. Ensure that the touchpad is equally aligned along all four sides.

- 3 Slide the touchpad cable into the connector on the system board and close the latch to secure the touchpad cable.

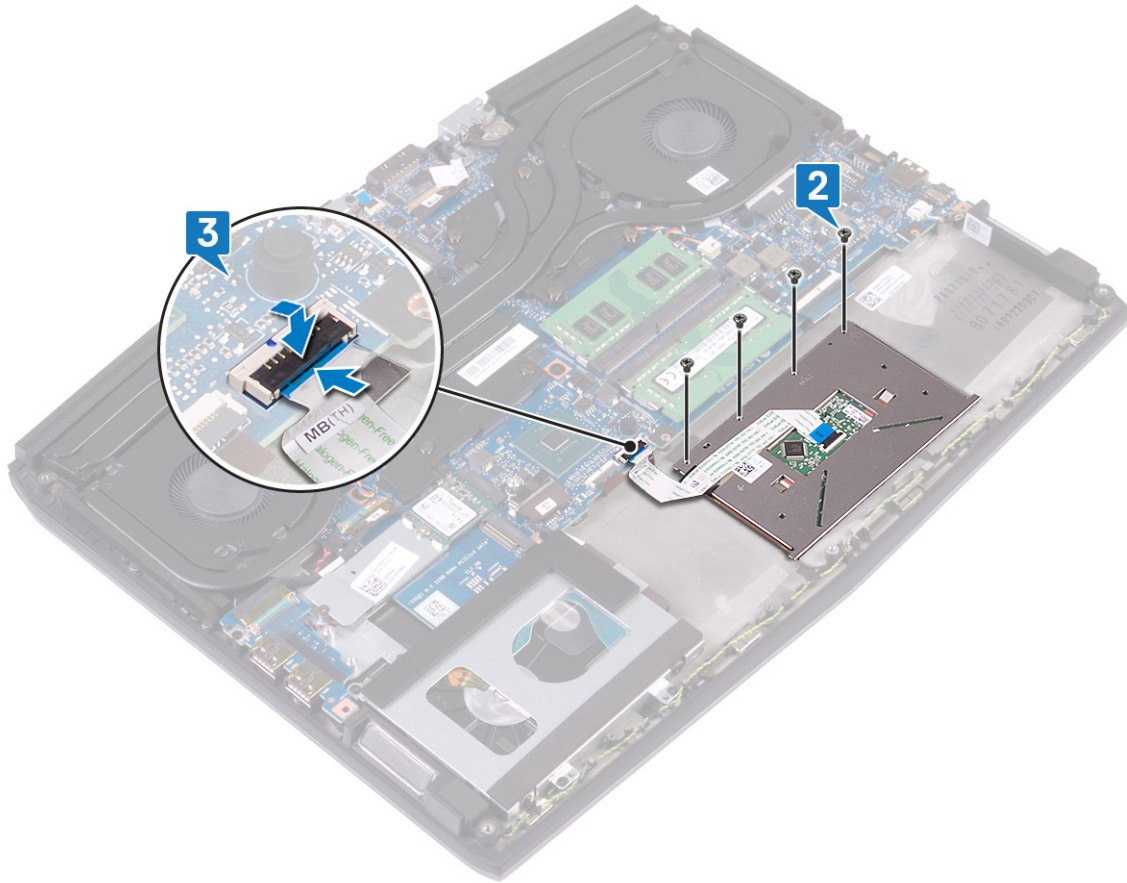

Post-requisites

- 1 Replace the [battery \(half-length\)](#) or the [battery \(full-length\)](#), whichever applicable.
- 2 Replace the [base cover](#).

Removing the speakers

WARNING: Before working inside your computer, read the safety information that shipped with your computer and follow the steps in [Before working inside your computer](#). After working inside your computer, follow the instructions in [After working inside your computer](#). For more safety best practices, see the Regulatory Compliance home page at www.dell.com/regulatory_compliance.

Prerequisites

- 1 Remove the [base cover](#).
- 2 Remove the [battery \(half-length\)](#) or the [battery \(full-length\)](#), whichever applicable.
- 3 Follow the procedure from step 1 to step 3 in [Removing the hard drive](#).
- 4 Remove the [I/O board](#).
- 5 Remove the [system board](#).

Procedure

- 1 Disconnect the speaker cable from the system board.
- 2 Note the speaker cable routing and remove it from the routing guides on palm-rest assembly.
- 3 Lift the speakers, along with the cable, off the palm-rest assembly.

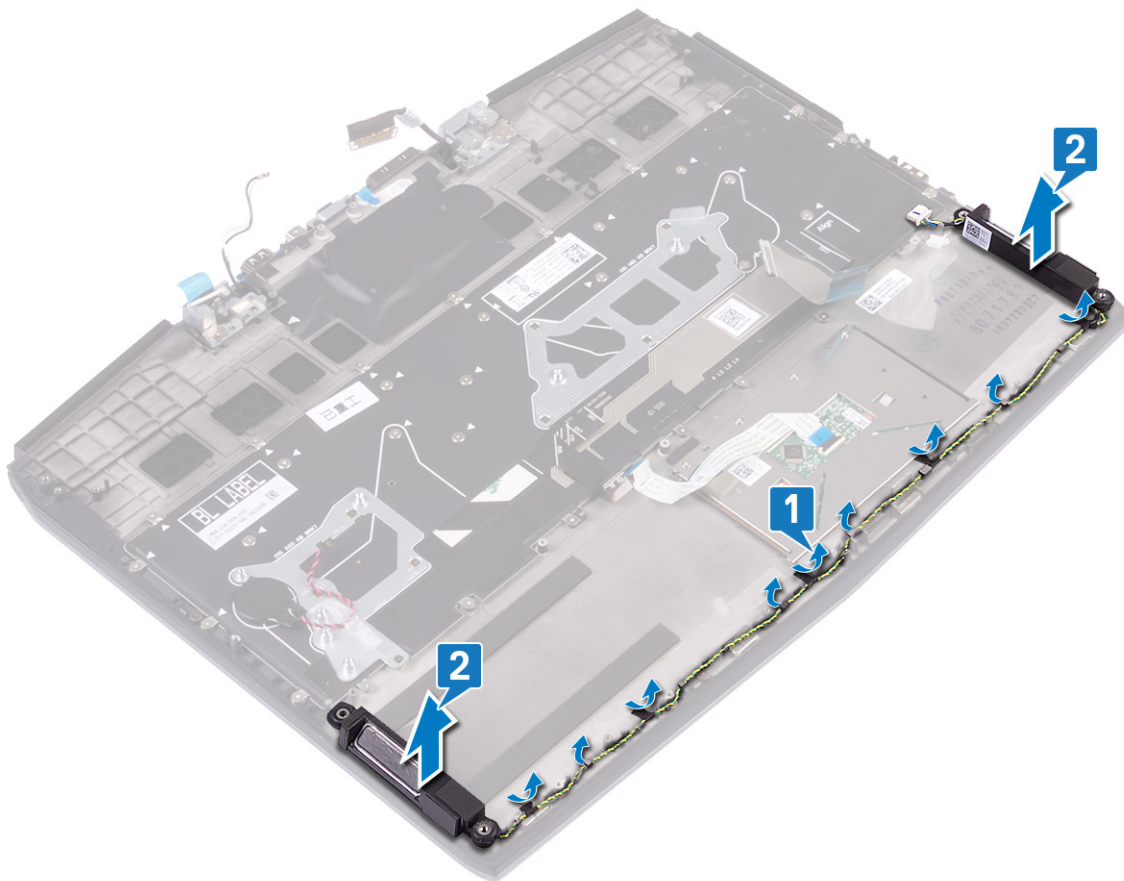

Replacing the speakers

WARNING: Before working inside your computer, read the safety information that shipped with your computer and follow the steps in [Before working inside your computer](#). After working inside your computer, follow the instructions in [After working inside your computer](#). For more safety best practices, see the Regulatory Compliance home page at www.dell.com/regulatory_compliance.

Procedure

NOTE: If the rubber grommets are pushed out of the speakers when removing the speakers, push them back in place before replacing the speakers.

- 1 Using the alignment posts and rubber grommets, place the speakers in the slots on the palm-rest assembly.
- 2 Route the speaker cable through the routing guides on the palm-rest assembly.
- 3 Connect the speaker cable to the system board.

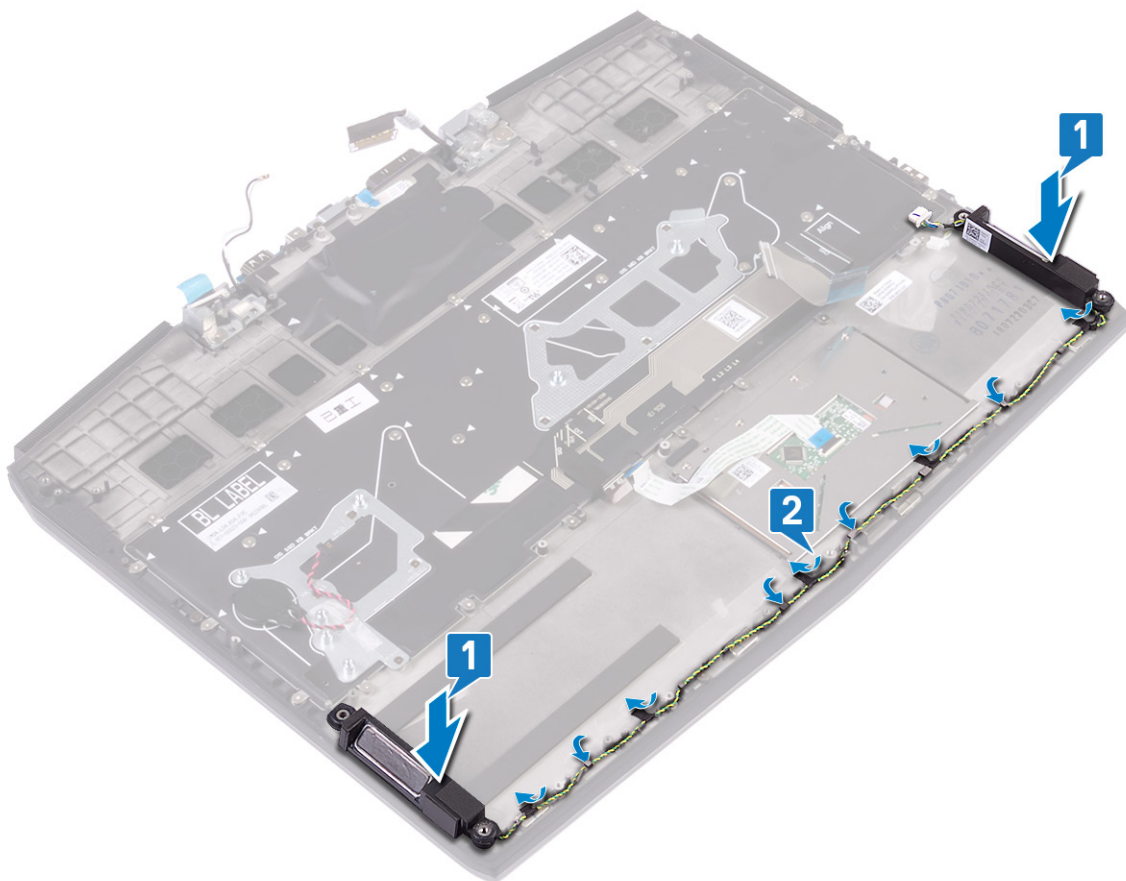

Post-requisites

- 1 Replace the [system board](#).
- 2 Replace the [I/O board](#).
- 3 Follow the procedure from step 4 to step 6 in [Replacing the hard drive](#).
- 4 Replace the [battery \(half-length\)](#) or the [battery \(full-length\)](#), whichever applicable.
- 5 Replace the [base cover](#).

Removing the power-adapter port

WARNING: Before working inside your computer, read the safety information that shipped with your computer and follow the steps in [Before working inside your computer](#). After working inside your computer, follow the instructions in [After working inside your computer](#). For more safety best practices, see the Regulatory Compliance home page at www.dell.com/regulatory_compliance.

Prerequisites

- 1 Remove the [base cover](#).
- 2 Follow the procedure from step 1 to step 6 in [Removing the heat sink](#).

Procedure

- 1 Disconnect the power-adapter port cable from the system board.
- 2 Peel the tape that secures the power-adapter port cable to the system board.
- 3 Remove the screw (M2x3) that secures the power-adapter port bracket to the system board and palm-rest assembly.
- 4 Rotate the power-adapter port bracket off the power-adapter port.
- 5 Lift the power-adapter port along with its cable off the palm-rest assembly.

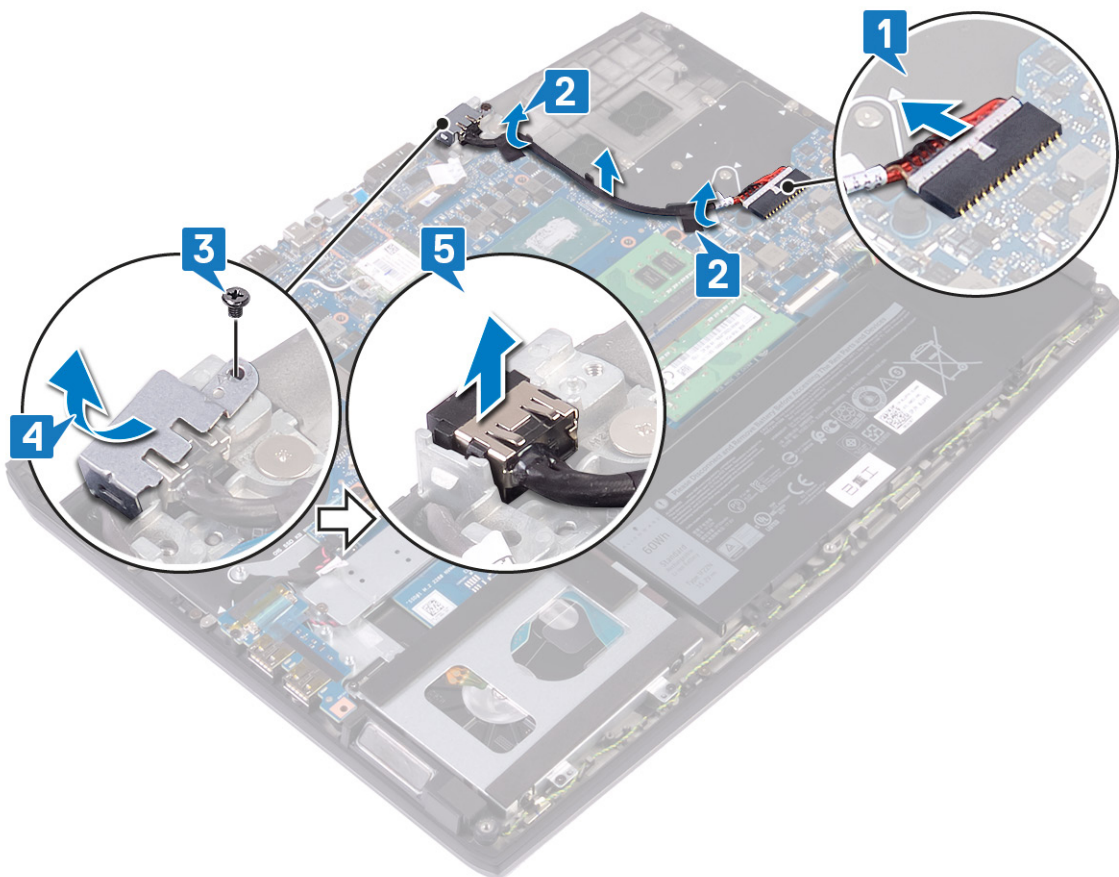

Replacing the power-adapter port

WARNING: Before working inside your computer, read the safety information that shipped with your computer and follow the steps in [Before working inside your computer](#). After working inside your computer, follow the instructions in [After working inside your computer](#). For more safety best practices, see the Regulatory Compliance home page at www.dell.com/regulatory_compliance.

Procedure

- 1 Connect the power-adapter port cable to the system board.
- 2 Adhere the tape that secures the power-adapter port cable to the system board.
- 3 Place the power-adapter port into the slot, and adhere the power-adapter port on the palm-rest assembly.
- 4 Clip and rotate the power-adapter port bracket onto the power-adapter port.
- 5 Replace the screw (M2x3) that secures the power-adapter port bracket to the system board and palm-rest assembly.

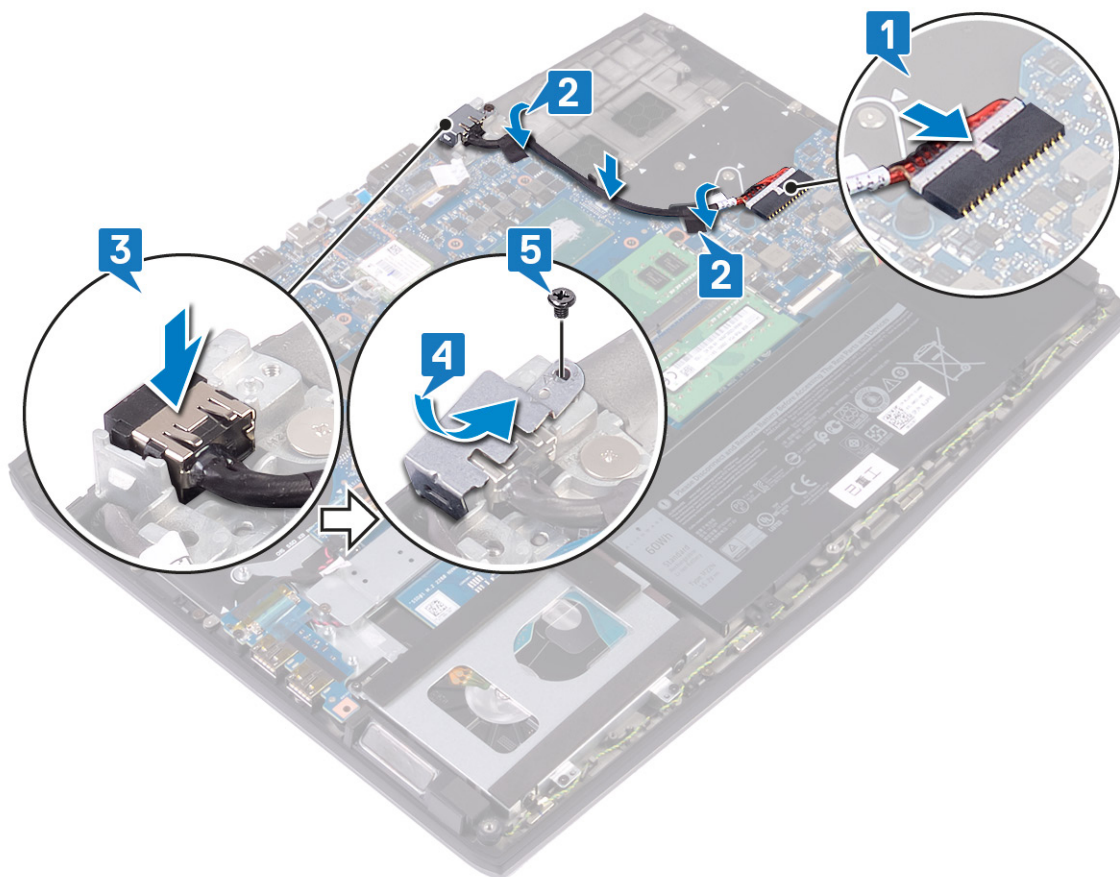

Post-requisites

- 1 Follow the procedure from step 2 to step 7 in [Replacing the heat sink](#).
- 2 Replace the [base cover](#).

Removing the display assembly

WARNING: Before working inside your computer, read the safety information that shipped with your computer and follow the steps in [Before working inside your computer](#). After working inside your computer, follow the instructions in [After working inside your computer](#). For more safety best practices, see the Regulatory Compliance home page at www.dell.com/regulatory_compliance.

Prerequisites

- 1 Remove the [base cover](#).
- 2 Remove the [wireless card](#).
- 3 Remove the [power-adaptor port](#).

Procedure

- 1 Peel the tape that secures the camera cable to the system board and disconnect the camera cable.
- 2 Peel the tape that secures the display cable to the system board.
- 3 Open the latch and disconnect the display cable from the system board.

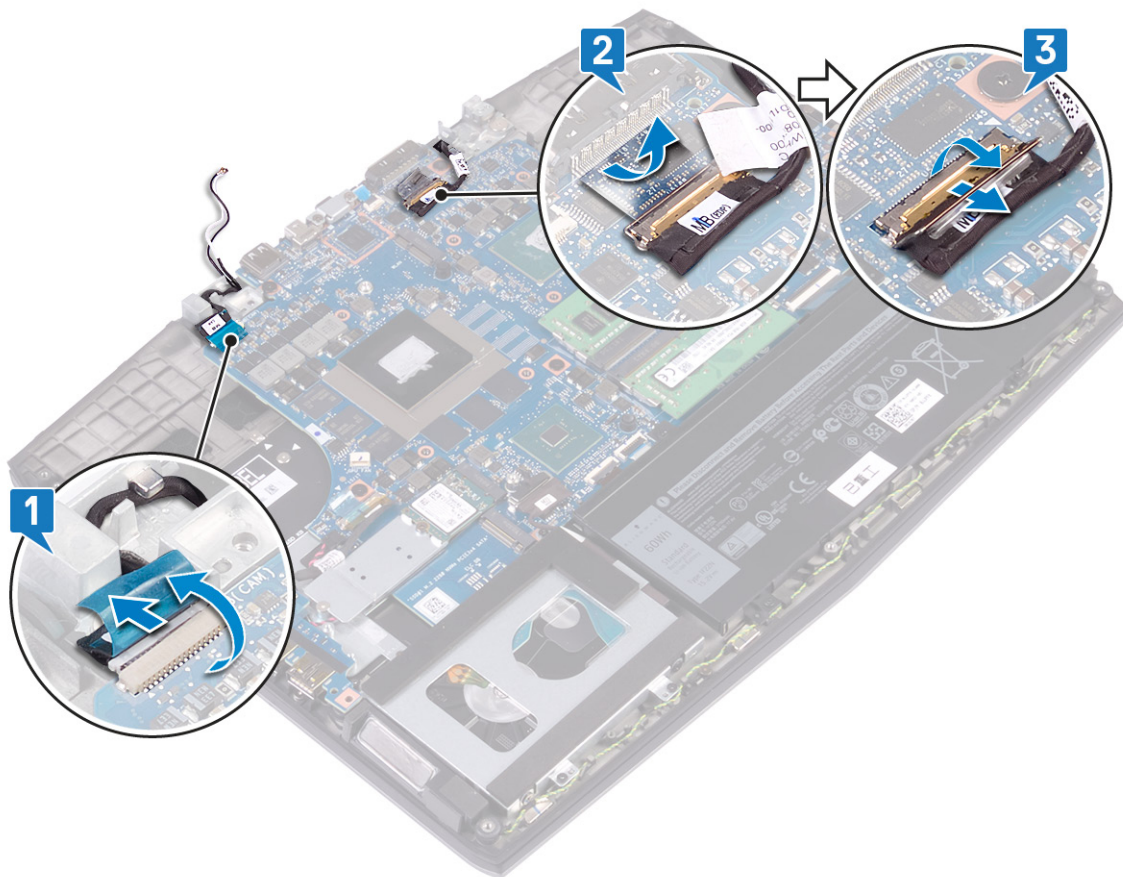

- 4 Open the display at an angle of 90 degrees.

- 5 Remove the two screws (M2.5x2.5) that secures the hinges to the palm-rest assembly.

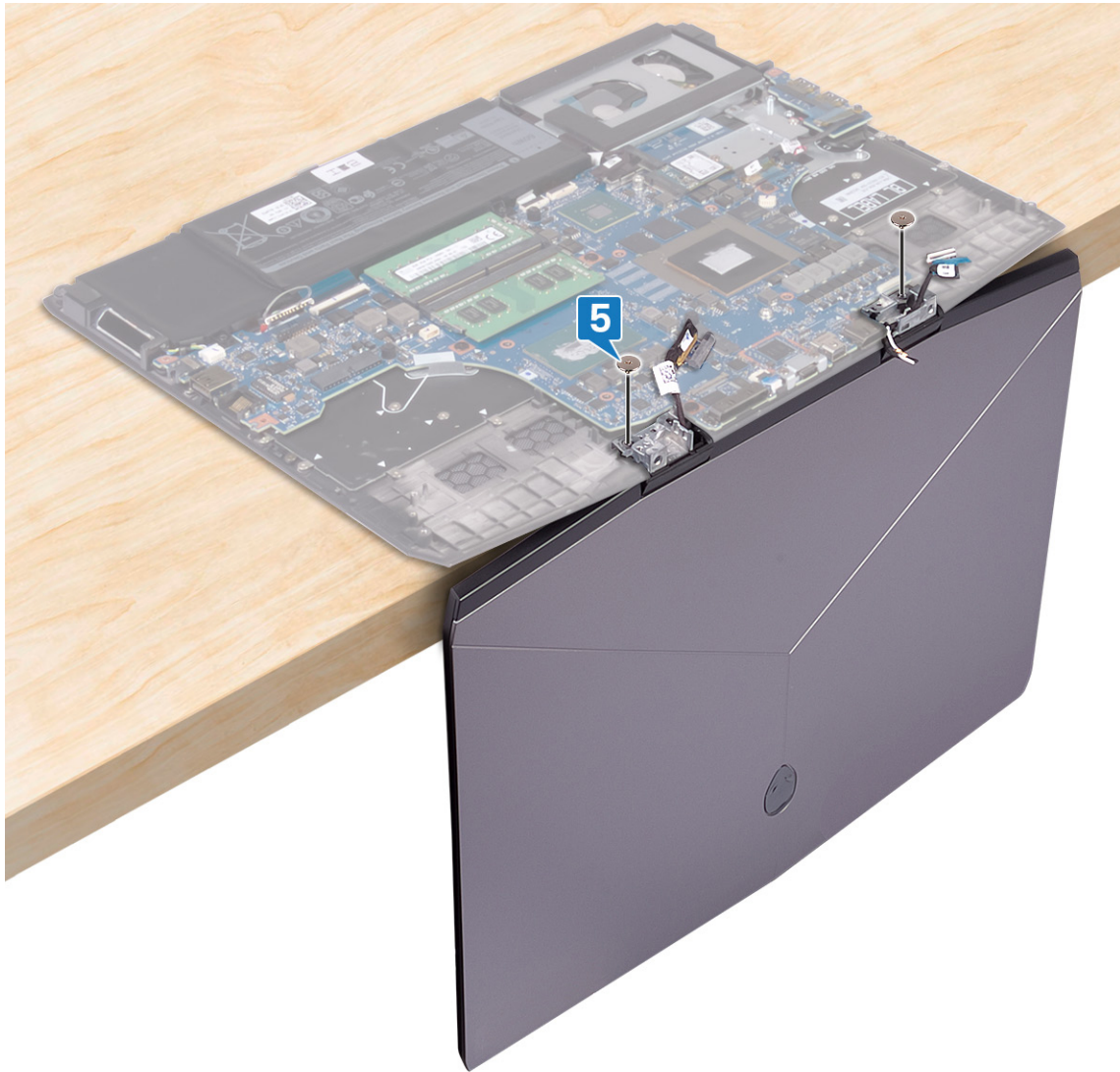

- 6 Rotate the display assembly inward and lift up and away from the palm-rest assembly.

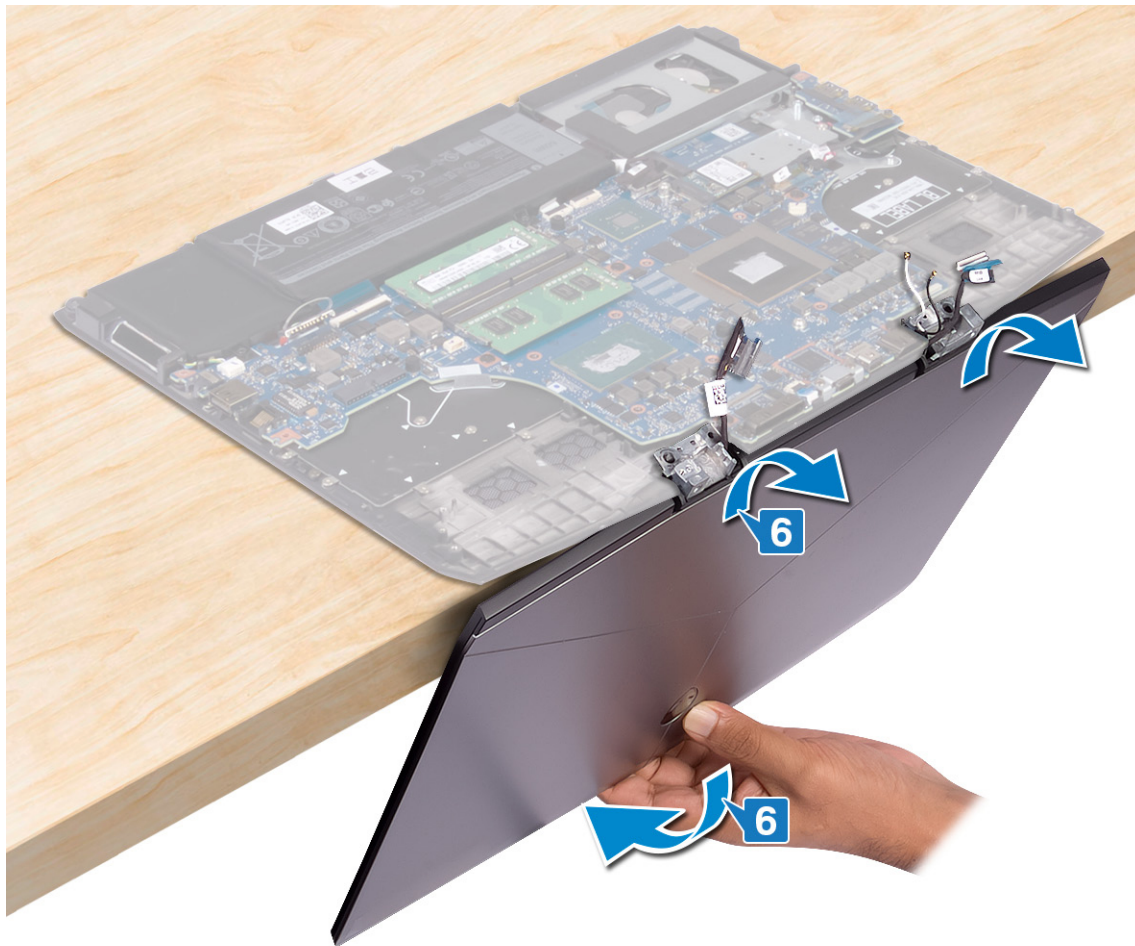

Replacing the display assembly

WARNING: Before working inside your computer, read the safety information that shipped with your computer and follow the steps in [Before working inside your computer](#). After working inside your computer, follow the instructions in [After working inside your computer](#). For more safety best practices, see the Regulatory Compliance home page at www.dell.com/regulatory_compliance.

Procedure

- 1 Open the hinges to 90 degree and place the display assembly on the palm-rest assembly by rotating outward.

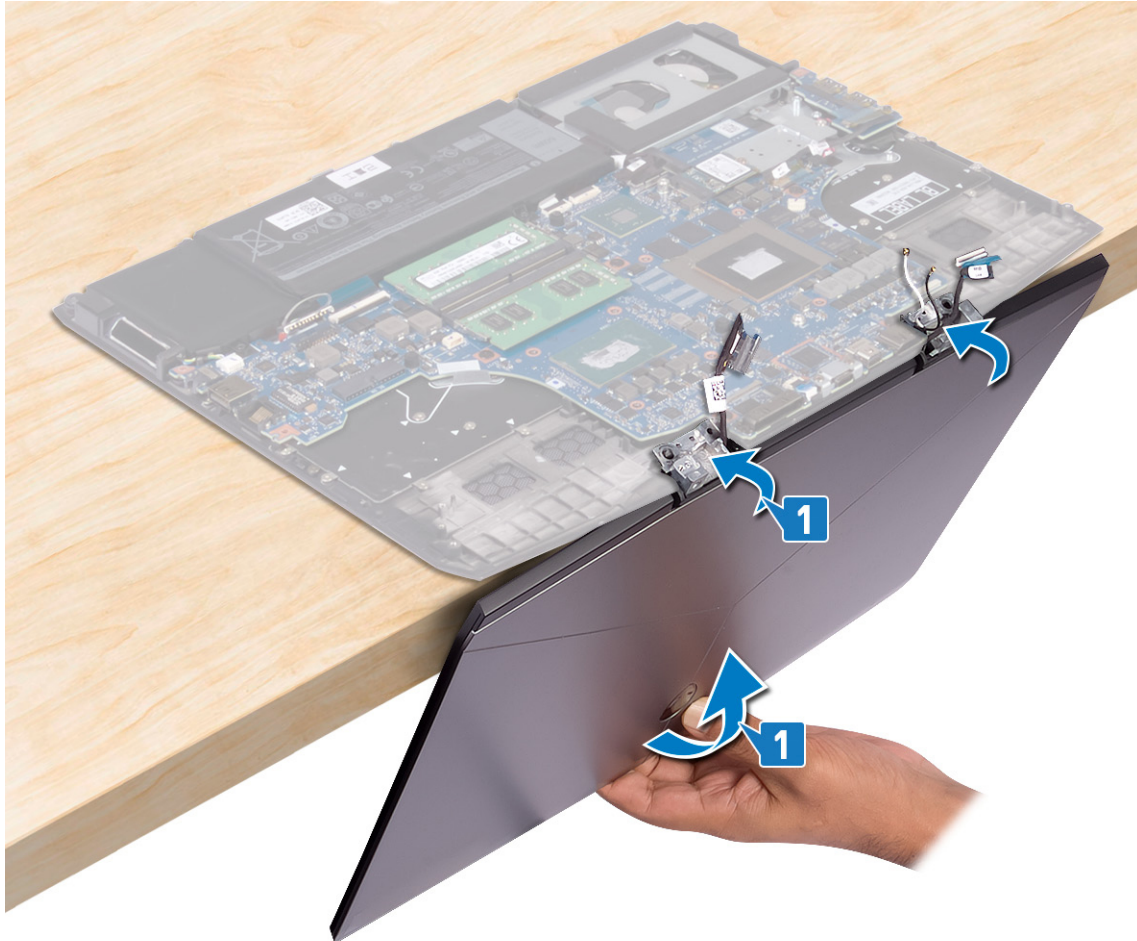

- 2 Replace the two screws (M2.5x2.5) that secures the hinges to the palm-rest assembly.

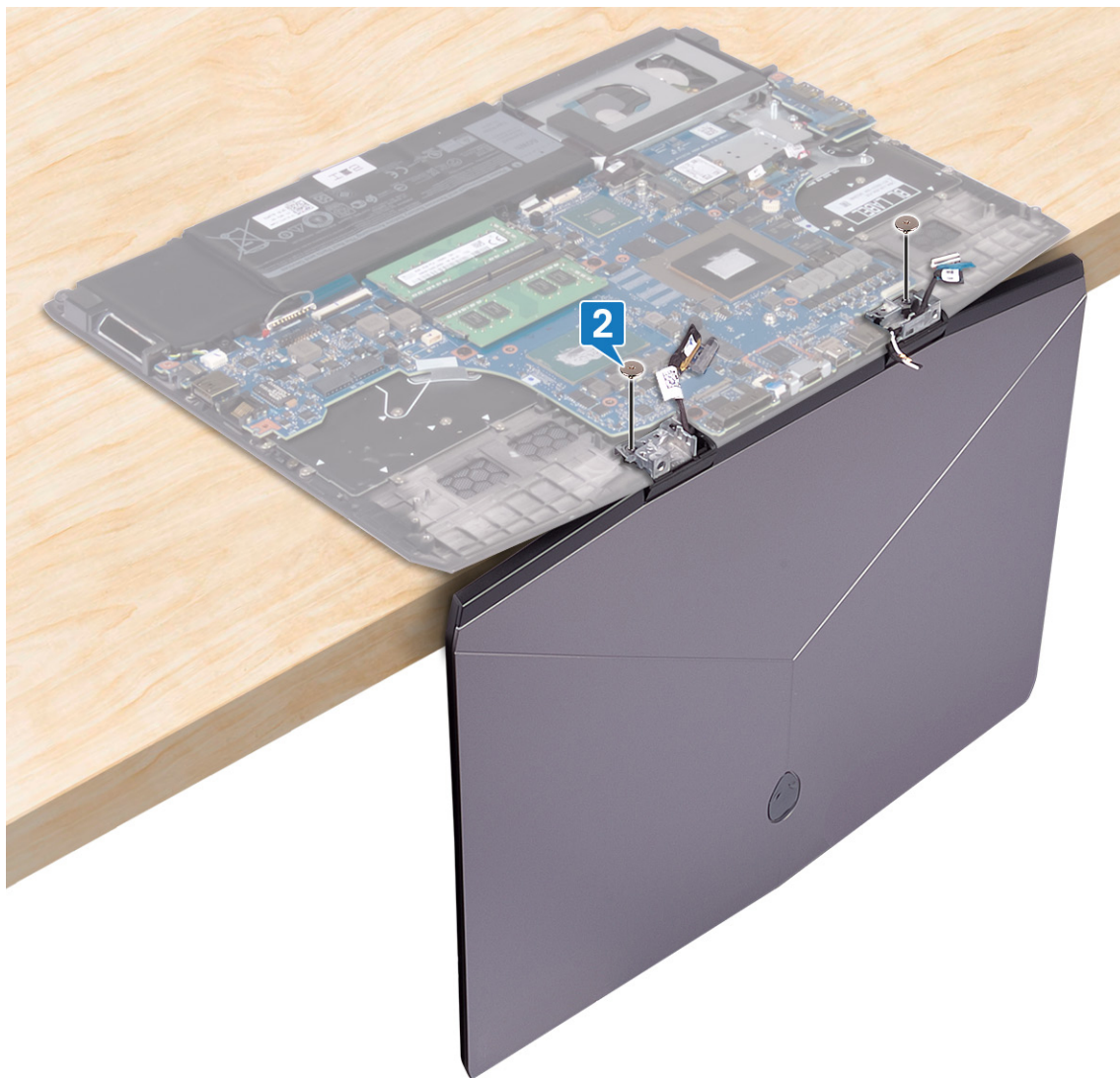

- 3 Close the display and turn the computer over.
- 4 Slide the display cable into the connector on the system board and close the latch to secure the cable.
- 5 Adhere the tape that secures the display cable to the system board.

- 6 Connect the camera cable to the system board and adhere the tape that secures the camera cable to the system board.

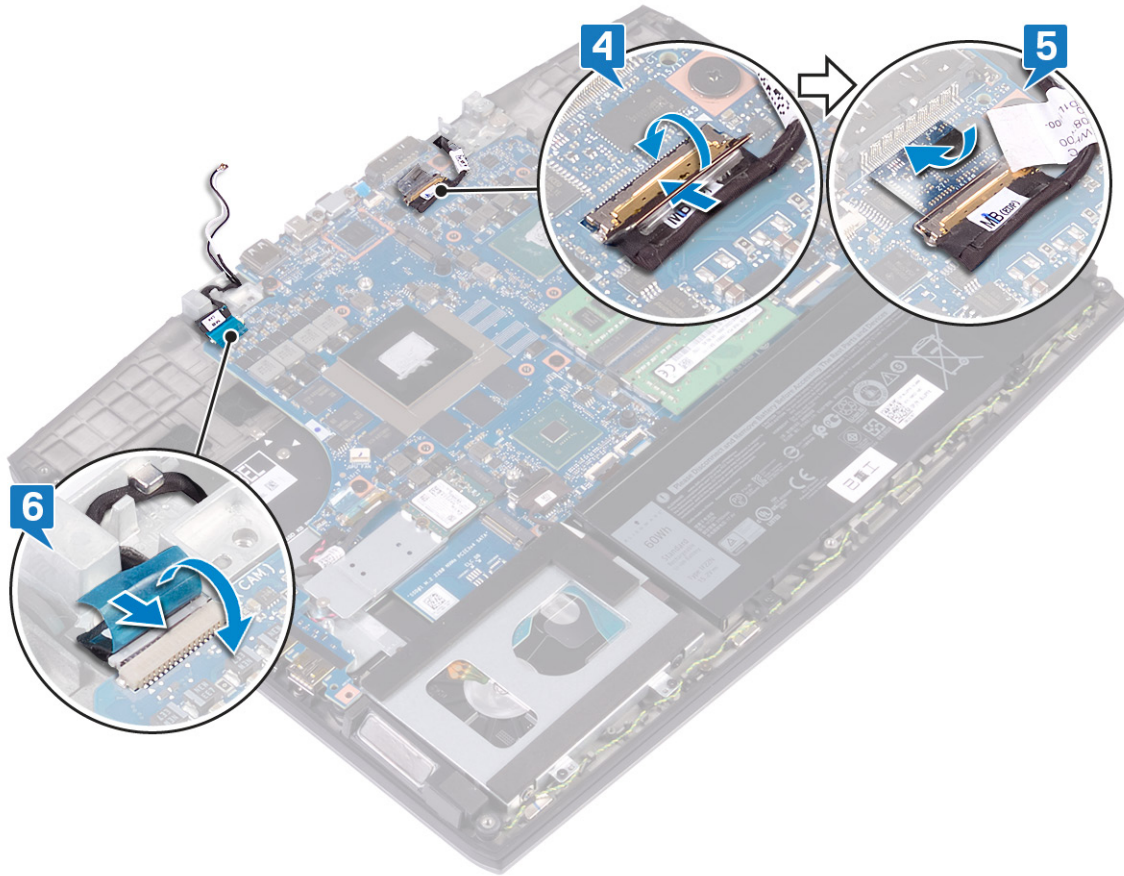

Post-requisites

- 1 Replace the [power-adapter port](#).
- 2 Replace the [wireless card](#).
- 3 Replace the [base cover](#).

Removing the system board

 **WARNING:** Before working inside your computer, read the safety information that shipped with your computer and follow the steps in [Before working inside your computer](#). After working inside your computer, follow the instructions in [After working inside your computer](#). For more safety best practices, see the Regulatory Compliance home page at www.dell.com/regulatory_compliance.

 **NOTE:** Your computer's Service Tag is stored in the system board. You must enter the Service Tag in the BIOS setup program after you replace the system board.

 **NOTE:** Replacing the system board removes any changes you have made to the BIOS using the BIOS setup program. You must make the appropriate changes again after you replace the system board.

 **NOTE:** Before disconnecting the cables from the system board, note the location of the connectors so that you can reconnect the cables correctly after you replace the system board.

Prerequisites

- 1 Remove the [base cover](#).
- 2 Remove the [battery \(half-length\)](#) or the [battery \(full-length\)](#), whichever applicable.
- 3 Follow the procedure from step 1 to step 3 in [Removing the hard drive](#).
- 4 Remove the [memory modules](#).
- 5 Remove the [wireless card](#).
- 6 Remove the [solid-state drive/Intel Optane](#).
- 7 Follow the procedure from step 1 to step 6 in [Removing the heat sink](#).
- 8 Remove the [power-adapter port](#).

Procedure

- 1 Remove the two screws (M2x3) that secure the USB Type-C port bracket to the system board.
- 2 Lift the USB Type-C port bracket from the system board.
- 3 Peel the tape that secures the display cable to the system board.

- 4 Open the latch and disconnect the display cable from the system board.

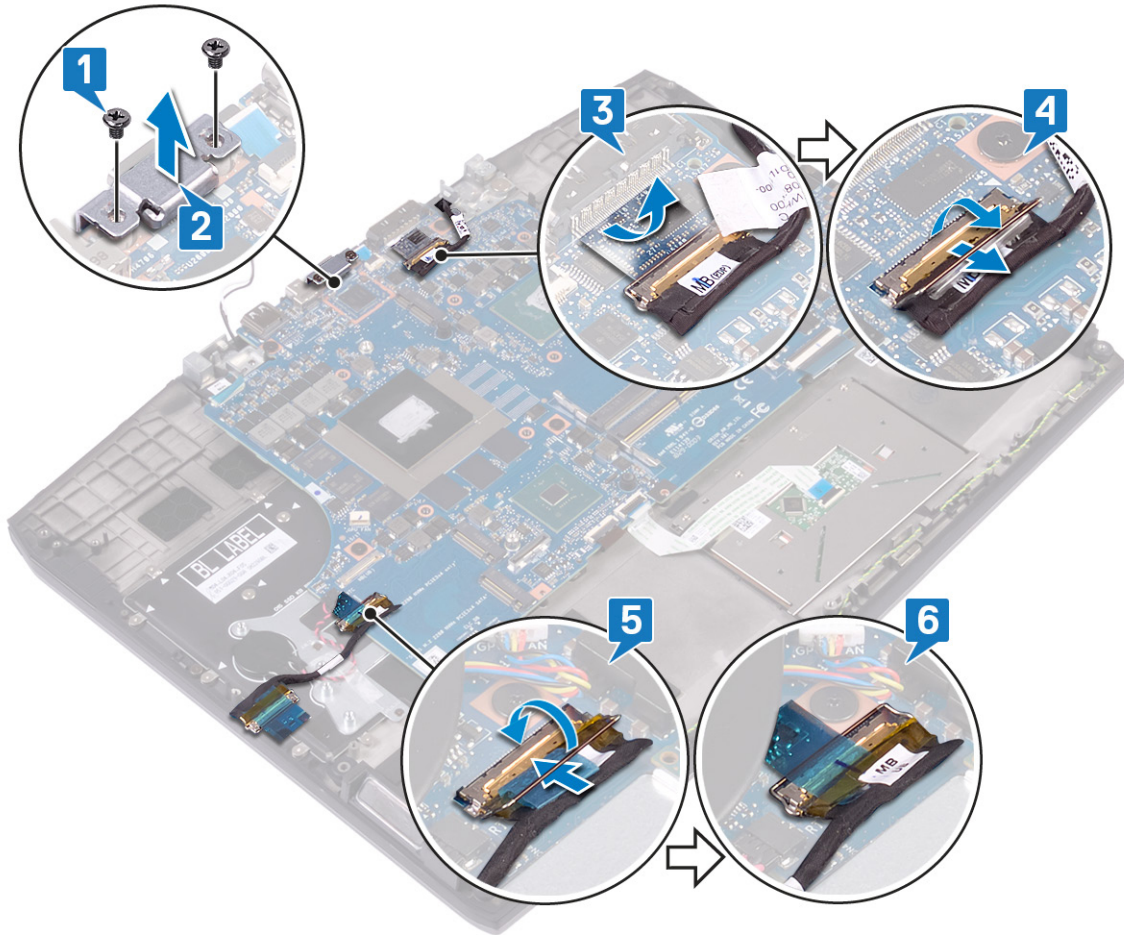

- 5 Disconnect the speaker cable from the system board.
6 Open the latch and disconnect the keyboard cable from the system board.
7 Open the latch and disconnect the touchpad cable from the system board.
8 Open the latch and disconnect the keyboard back-light cable from the system board.
9 Disconnect the coin-cell battery from the system board.
10 Disconnect the camera cable from the system board.

11 Disconnect the power-button cable from the system board.

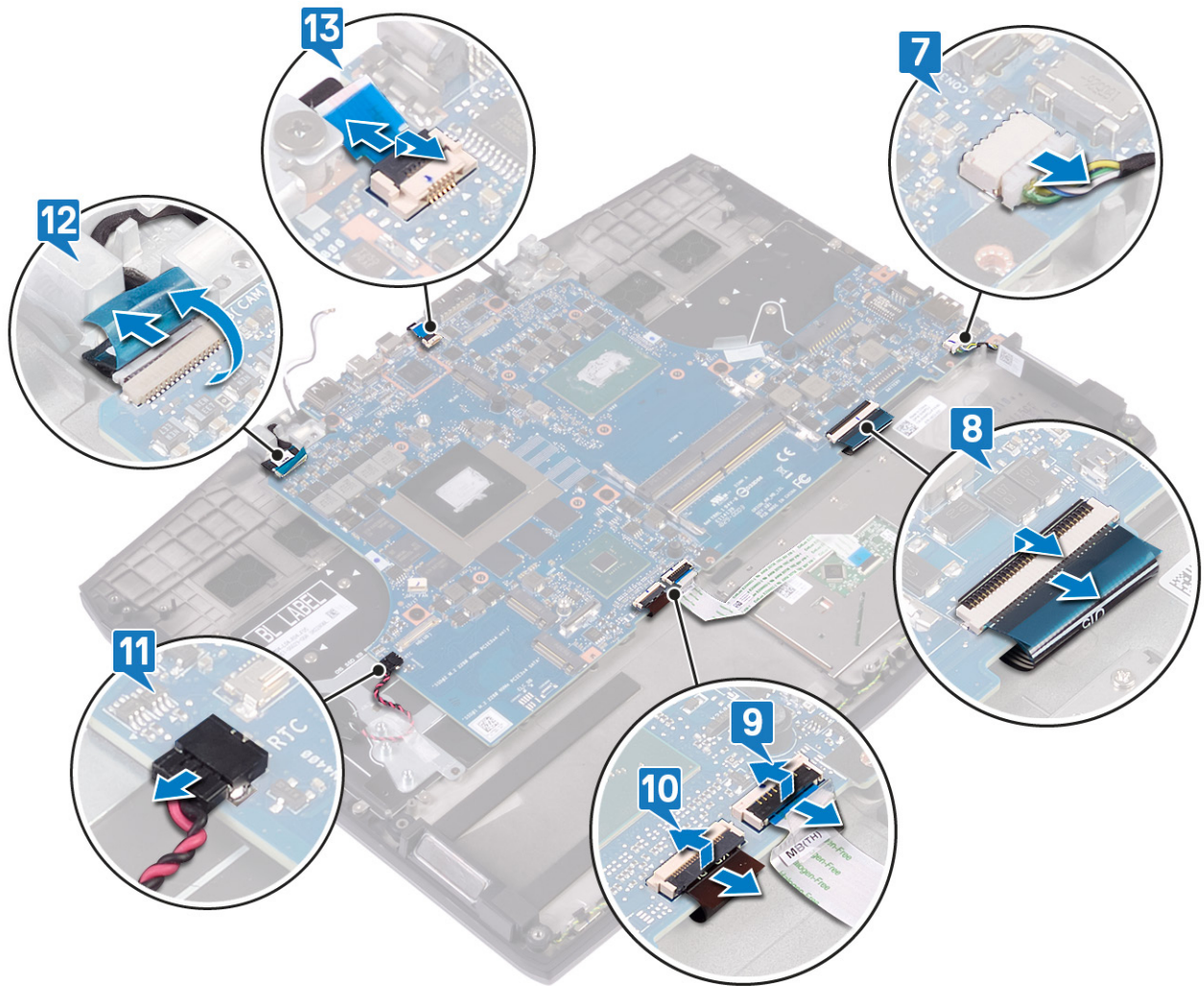

12 Remove the five screws (M2x2) that secure the system board to palm-rest assembly.

13 Lift the system board off the palm-rest assembly.

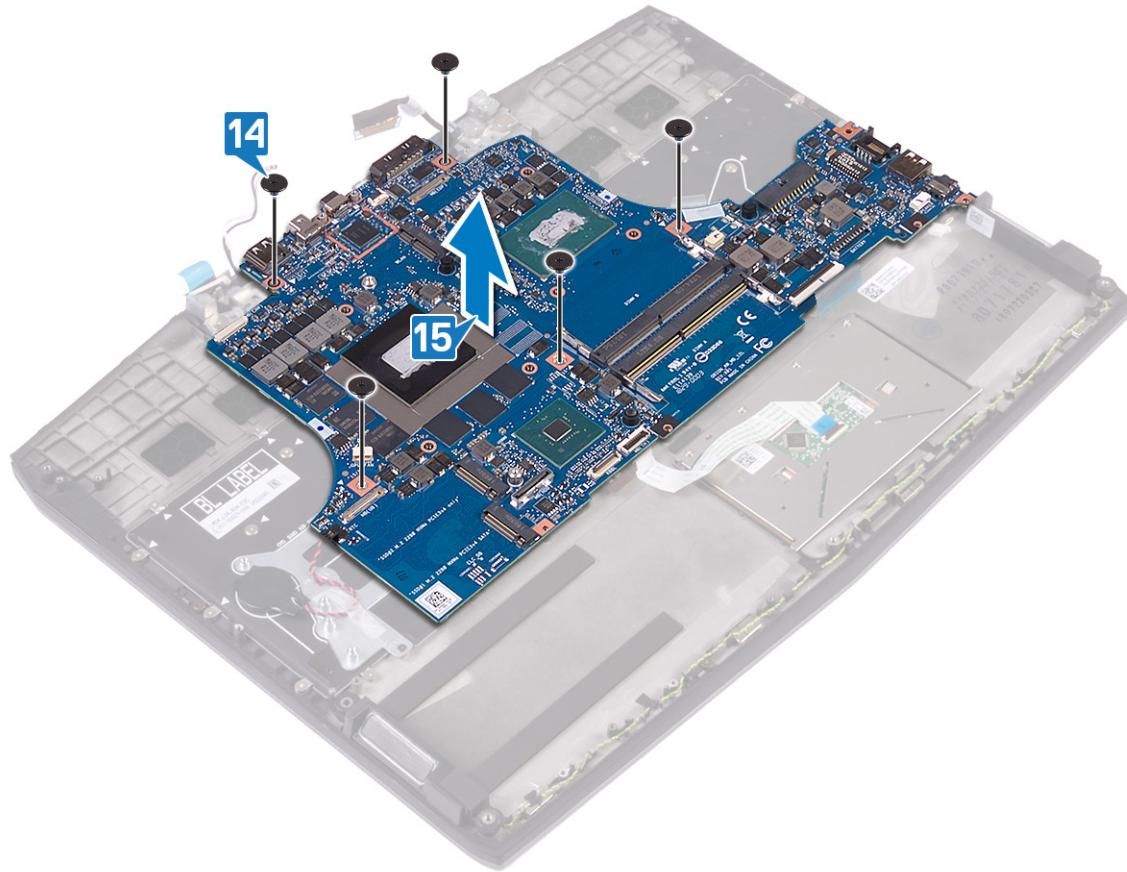

Replacing the system board

WARNING: Before working inside your computer, read the safety information that shipped with your computer and follow the steps in [Before working inside your computer](#). After working inside your computer, follow the instructions in [After working inside your computer](#). For more safety best practices, see the Regulatory Compliance home page at www.dell.com/regulatory_compliance.

NOTE: Your computer's Service Tag is stored in the system board. You must enter the Service Tag in the BIOS setup program after you replace the system board.

NOTE: Replacing the system board removes any changes you have made to the BIOS using the BIOS setup program. You must make the appropriate changes again after you replace the system board.

Procedure

- 1 Align the screw hole on the system board with the screw hole on the palm-rest assembly.
- 2 Replace the five screws (M2x2) that secure the system board to the palm-rest assembly.

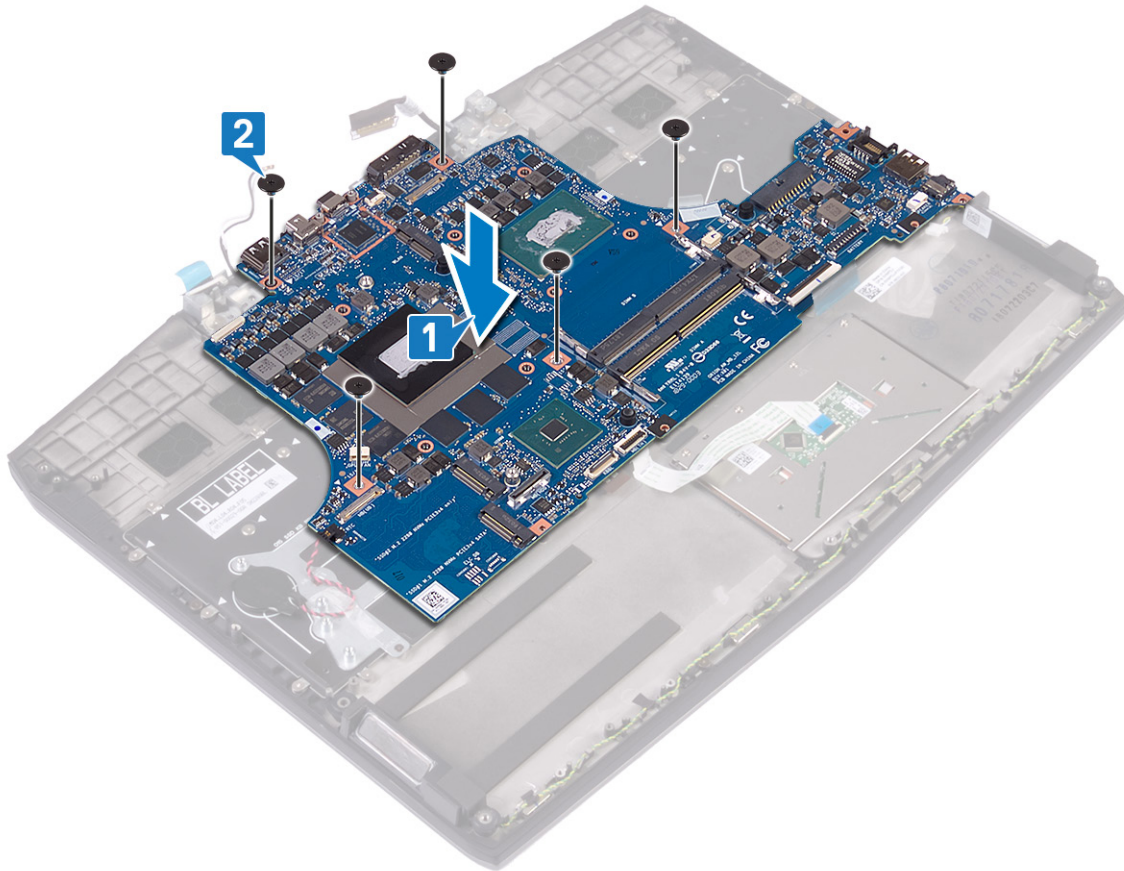

- 3 Connect the power-button cable to the system board.
- 4 Connect the camera cable to the system board and close the latch to secure the cable.
- 5 Connect the coin-cell battery to the system board.
- 6 Connect the keyboard back-light cable to the system board and close the latch to secure the cable.
- 7 Connect the touchpad cable to the system board and close the latch to secure the cable.
- 8 Connect the keyboard cable to the system board and close the latch to secure the cable.

9 Connect the speaker cable to the system board.

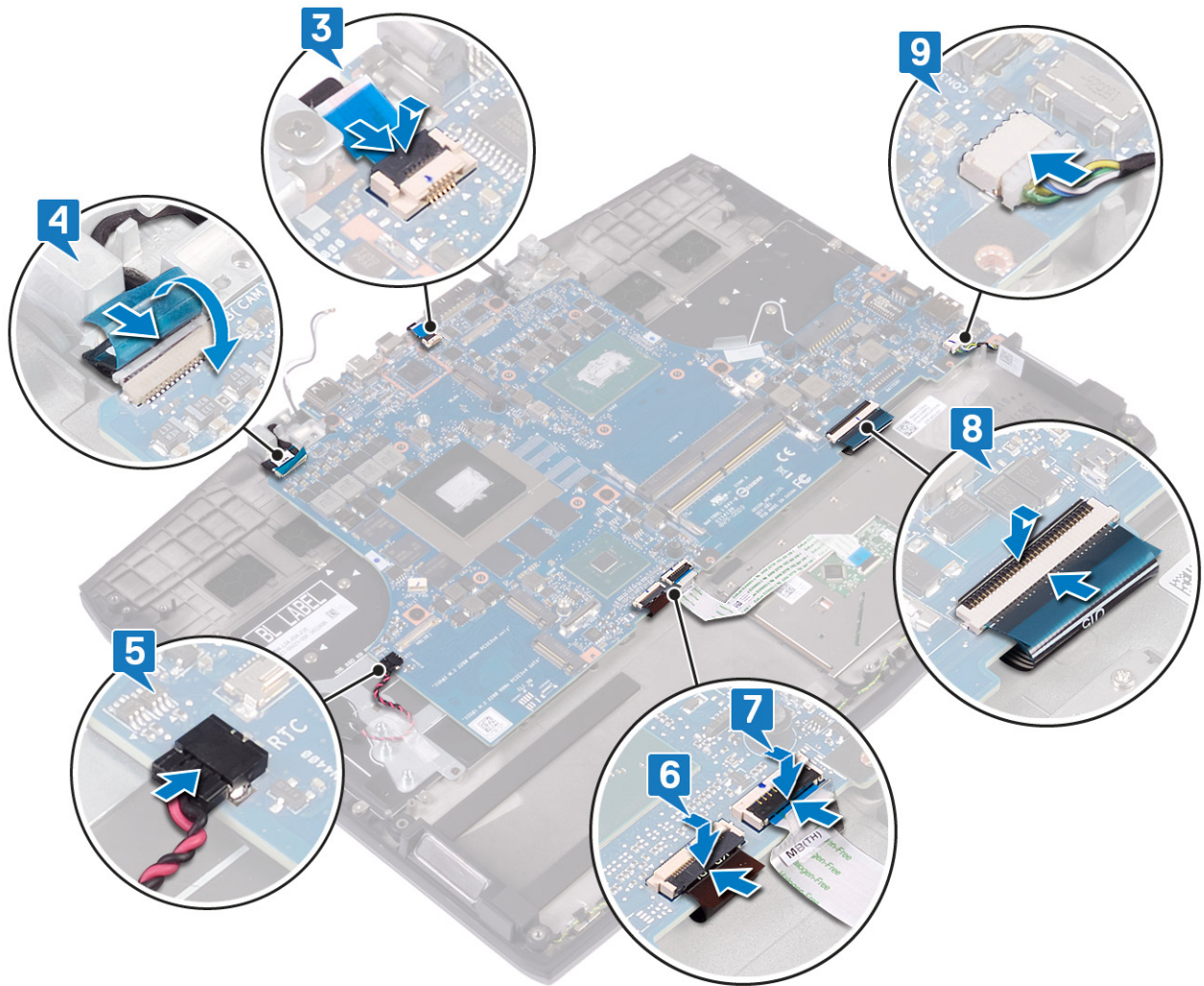

10 Connect the display cable and close the latch to secure the cable.

11 Adhere the tape that secures the display cable to the system board.

12 Align the screw holes of the USB Type-C port bracket with the screw holes on the system board.

13 Replace the two screws (M2x3) that secure the USB Type-C port bracket to the system board.

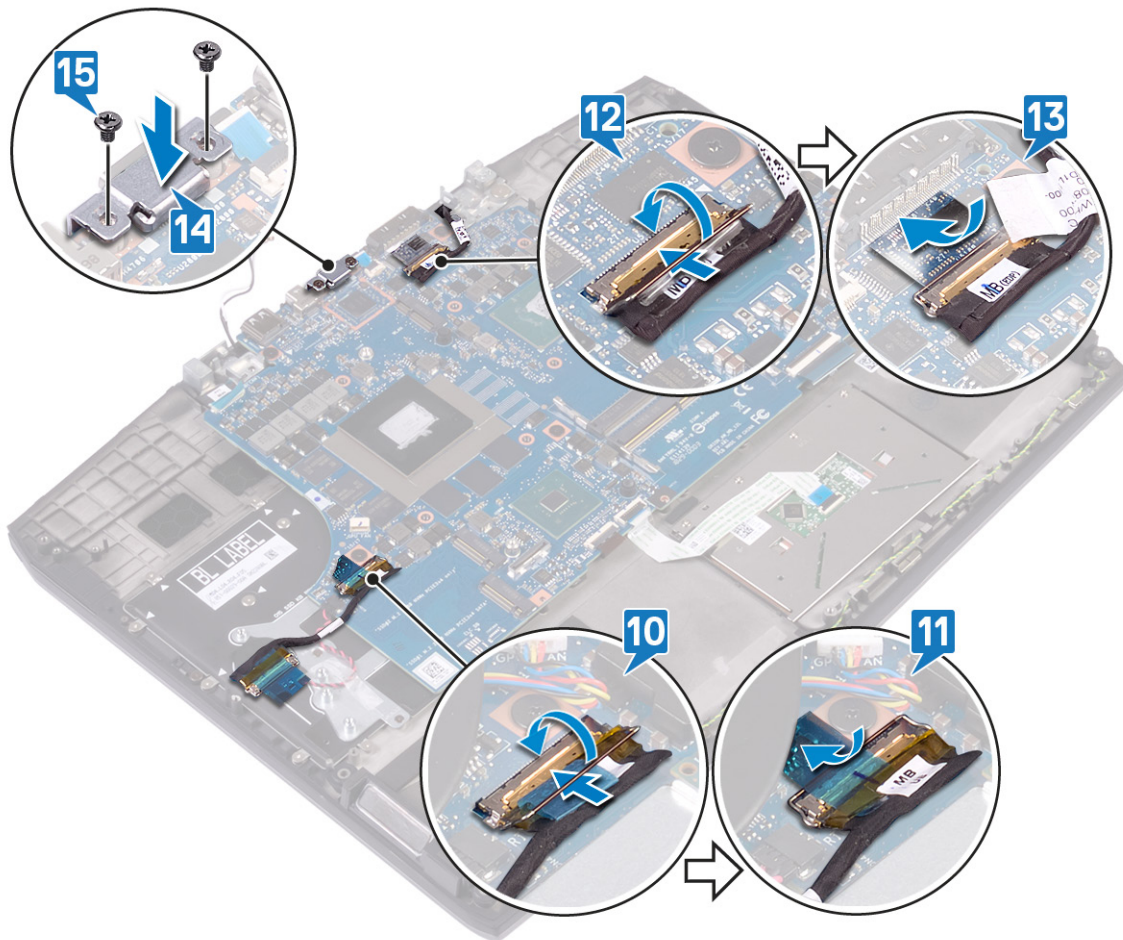

Post-requisites

- 1 Replace the [power-adaptor port](#).
- 2 Follow the procedure from step 2 to step 7 in [Replacing the heat sink](#).
- 3 Replace the [solid-state drive/Intel Optane](#).
- 4 Replace the [wireless card](#).
- 5 Replace the [memory modules](#).
- 6 Follow the procedure from step 4 to step 6 in [Replacing the hard drive](#).
- 7 Replace the [battery \(half-length\)](#) or the [battery \(full-length\)](#), whichever applicable.
- 8 Replace the [base cover](#).

Entering the Service Tag in the BIOS setup program

- 1 Turn on or restart your computer.
- 2 Press F2 when the Dell logo is displayed to enter the BIOS setup program.
- 3 Navigate to the **Main** tab and enter the Service Tag in the **Service Tag Input** field.

 **NOTE:** Service tag is the alphanumeric identifier located at the back side of your computer.

Removing the power-button board

⚠ WARNING: Before working inside your computer, read the safety information that shipped with your computer and follow the steps in [Before working inside your computer](#). After working inside your computer, follow the instructions in [After working inside your computer](#). For more safety best practices, see the Regulatory Compliance home page at www.dell.com/regulatory_compliance.

Prerequisites

- 1 Remove the [base cover](#).
- 2 Remove the [battery \(half-length\)](#) or the [battery \(full-length\)](#), whichever applicable.
- 3 Follow the procedure from step 1 to step 3 in [Removing the hard drive](#).
- 4 Remove the [wireless card](#).
- 5 Follow the procedure from step 1 to step 6 in [Removing the heat sink](#).
- 6 Remove the [solid-state drive/Intel Optane](#).
- 7 Remove the [power-adaptor port](#).
- 8 Remove the [system board](#).

Procedure

- 1 Peel the Mylar that covers the power-button board to the palm-rest assembly.
- 2 Remove the three screws (M2x3) that secure the power-button board to palm-rest assembly.
- 3 Lift the power-button board off the palm-rest assembly.

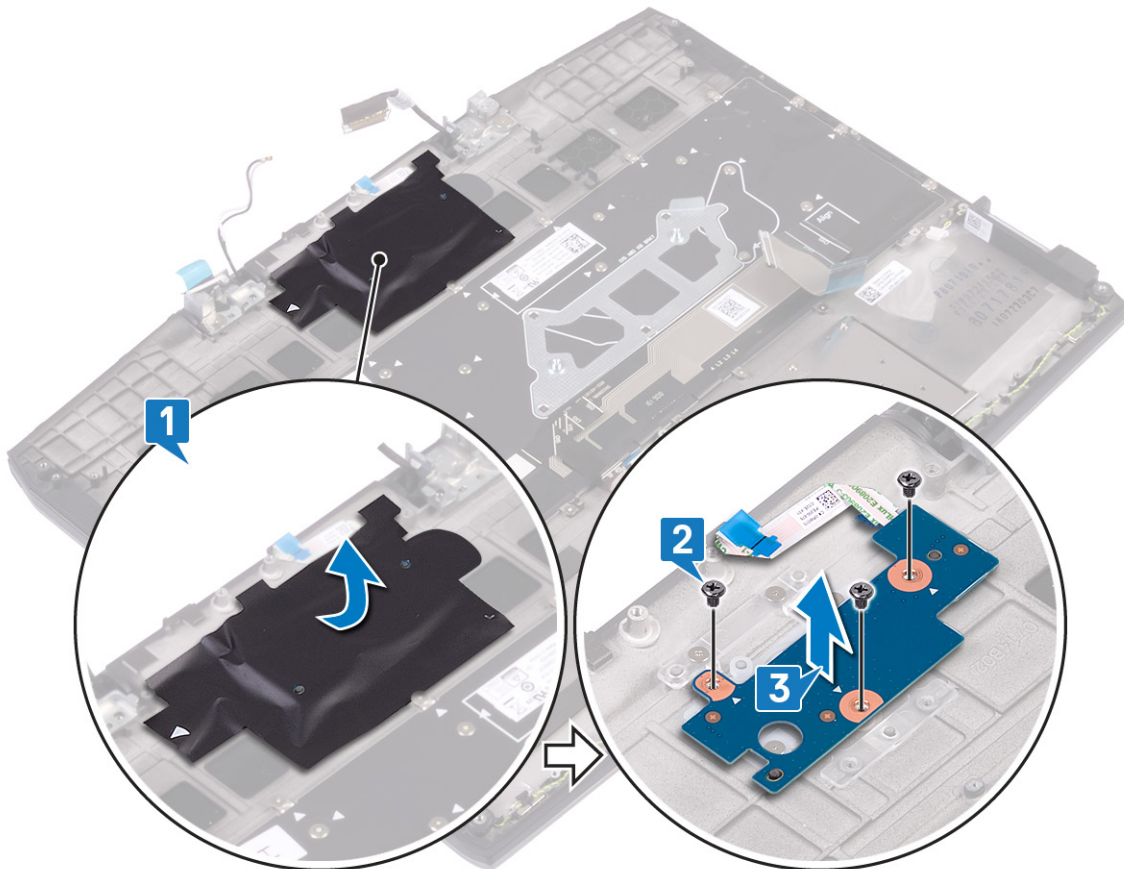

Replacing the power-button board

WARNING: Before working inside your computer, read the safety information that shipped with your computer and follow the steps in [Before working inside your computer](#). After working inside your computer, follow the instructions in [After working inside your computer](#). For more safety best practices, see the Regulatory Compliance home page at www.dell.com/regulatory_compliance.

Procedure

- 1 Align the screw holes on the power-button board with the screw holes on the palm-rest assembly.
- 2 Replace the three screws (M2x3) that secure the power-button board to the palm-rest assembly.
- 3 Adhere the Mylar that covers the power-button board to the palm-rest assembly.

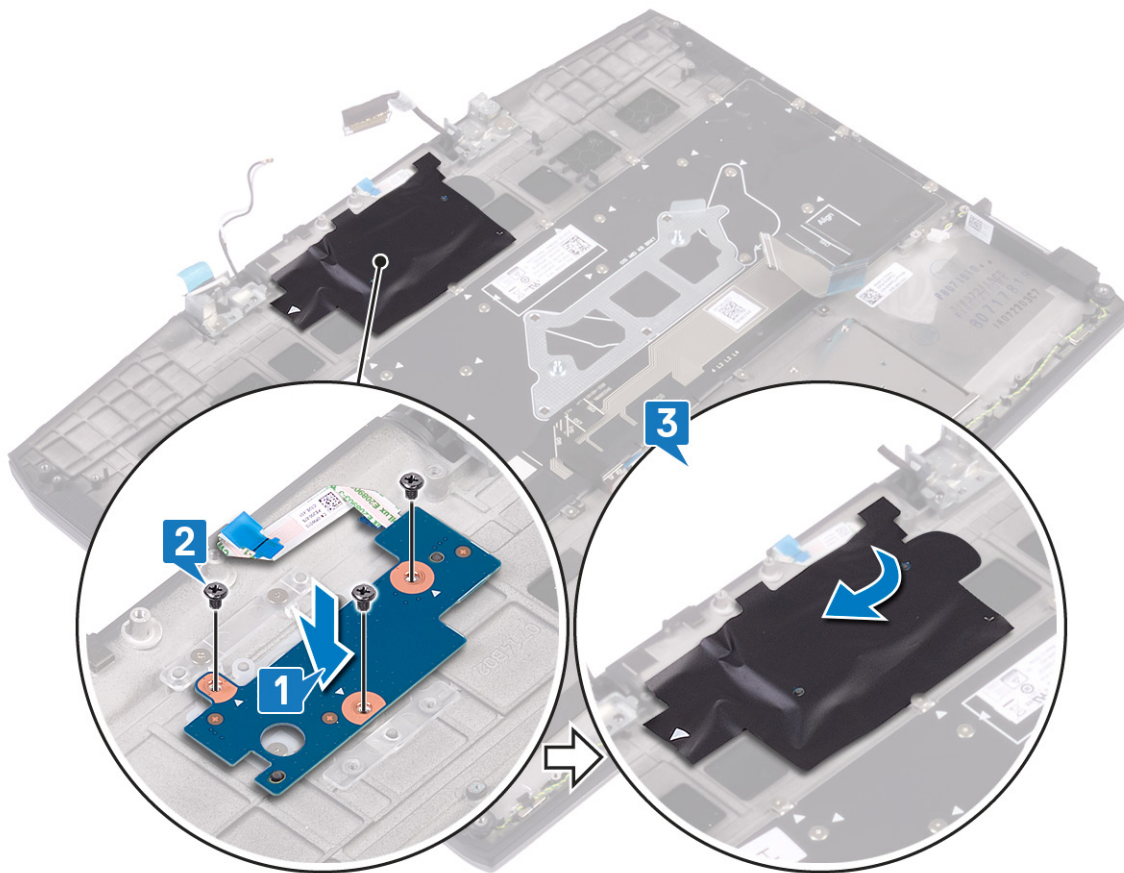

Post-requisites

- 1 Replace the [system board](#).
- 2 Replace the [power-adapter port](#).
- 3 Replace the [solid-state drive/Intel Optane](#).
- 4 Follow the procedure from step 2 to step 7 in [Replacing the heat sink](#).
- 5 Replace the [wireless card](#).
- 6 Follow the procedure from step 4 to step 6 in [Replacing the hard drive](#).
- 7 Replace the [battery \(half-length\)](#) or the [battery \(full-length\)](#), whichever applicable.
- 8 Replace the [base cover](#).

Removing the keyboard

WARNING: Before working inside your computer, read the safety information that shipped with your computer and follow the steps in [Before working inside your computer](#). After working inside your computer, follow the instructions in [After working inside your computer](#). For more safety best practices, see the Regulatory Compliance home page at www.dell.com/regulatory_compliance.

Prerequisites

- 1 Remove the [base cover](#).
- 2 Remove the [battery \(half-length\)](#) or the [battery \(full-length\)](#), whichever applicable.
- 3 Follow the procedure from step 1 to step 3 in [Removing the hard drive](#).
- 4 Remove the [wireless card](#).
- 5 Follow the procedure from step 1 to step 6 in [Removing the heat sink](#).
- 6 Remove the [I/O board](#).
- 7 Remove the [solid-state drive/Intel Optane](#).
- 8 Remove the [coin-cell battery](#).
- 9 Remove the [power-adaptor port](#).
- 10 Remove the [system board](#).

Procedure

- 1 Peel the keyboard Mylar off the keyboard bracket.

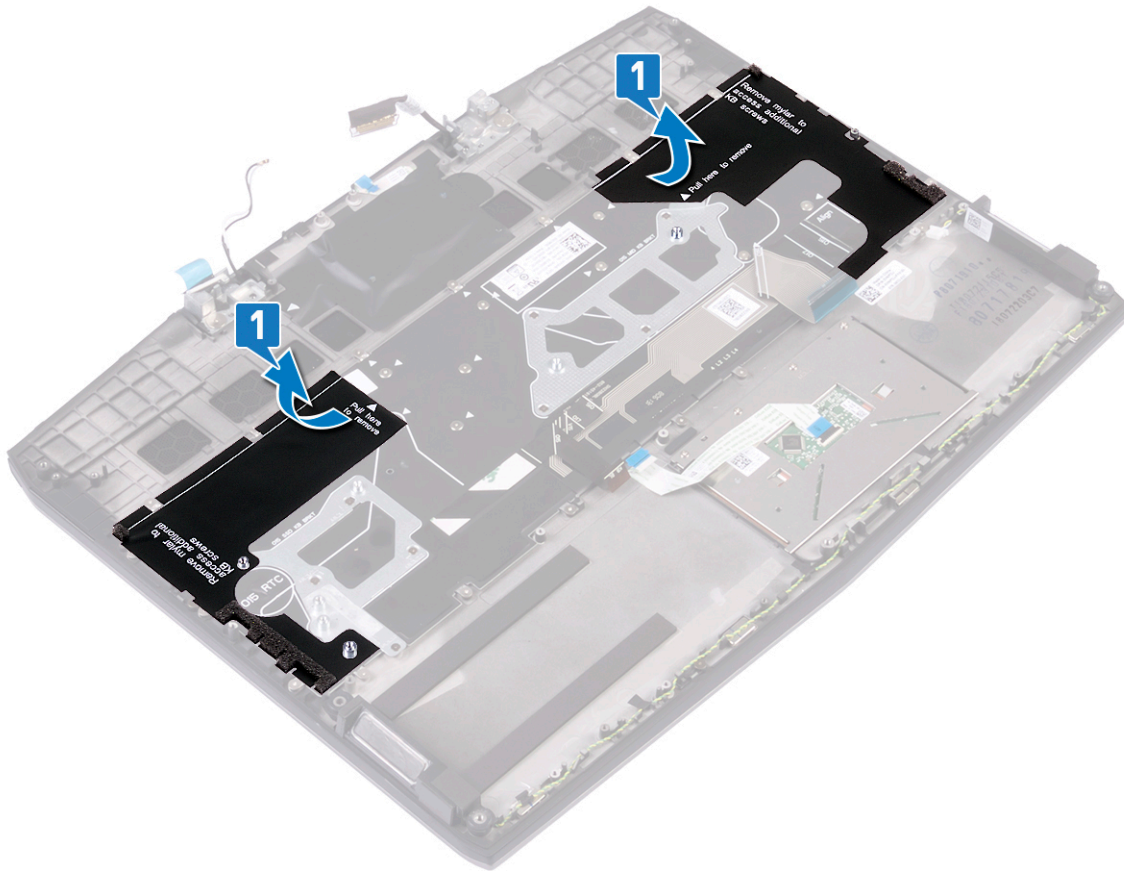

- 2 Remove the eight screws (M1.2x2.2) that secure the keyboard bracket to the palm-rest assembly.
- 3 Remove the 33 screws (M1.2x1.9) that secure the keyboard to the palm-rest assembly.
- 4 Lift the keyboard off the palm-rest assembly.

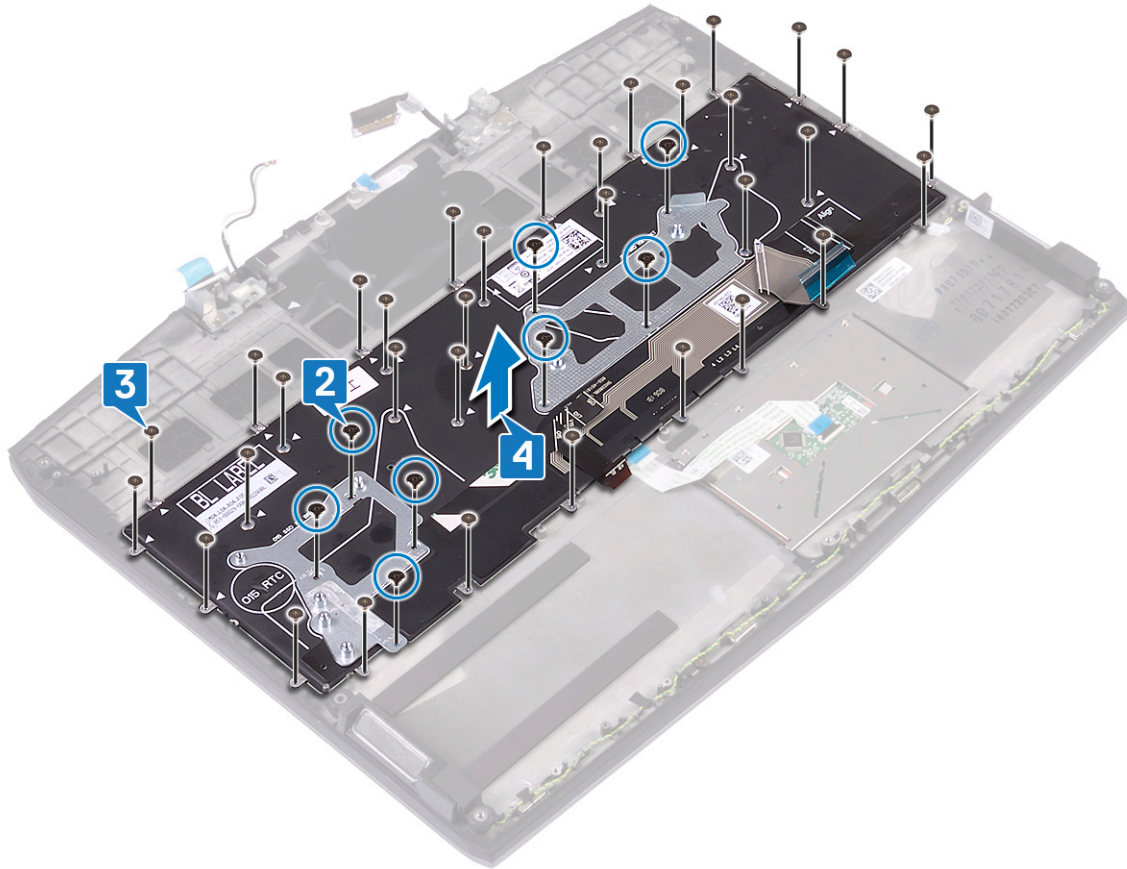

Replacing the keyboard

 **WARNING:** Before working inside your computer, read the safety information that shipped with your computer and follow the steps in [Before working inside your computer](#). After working inside your computer, follow the instructions in [After working inside your computer](#). For more safety best practices, see the Regulatory Compliance home page at www.dell.com/regulatory_compliance.

Procedure

- 1 Align the screw holes on the keyboard with the screw holes on the palm-rest assembly.
- 2 Replace the 33 screws (M1.2x1.9) that secure the keyboard to the palm-rest assembly.

- 3 Replace the eight screws (M1.2x2.2) that secure the keyboard bracket to the palm-rest assembly.

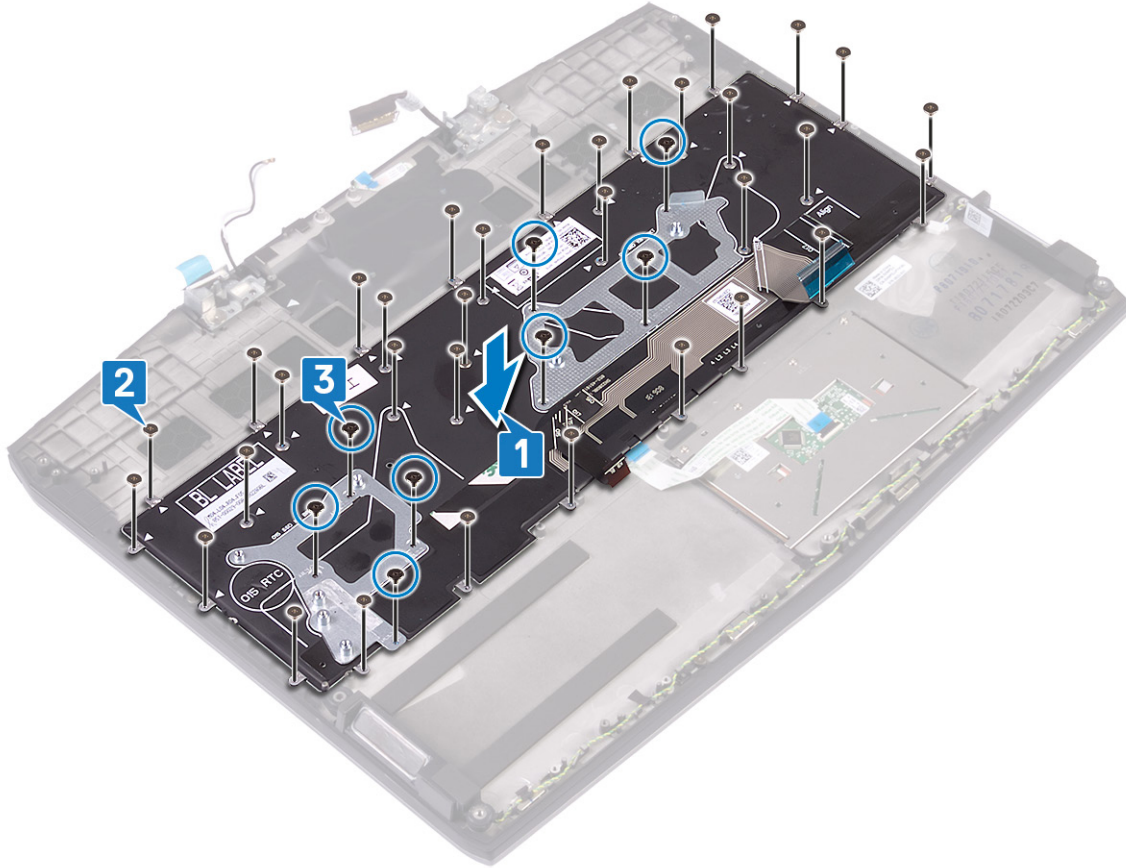

NOTE: The keyboard is shipped with a Mylar, that has to be adhered to the keyboard bracket after replacing the screws. Mylar has three layers: clear release paper, black Mylar, and blue Mylar.

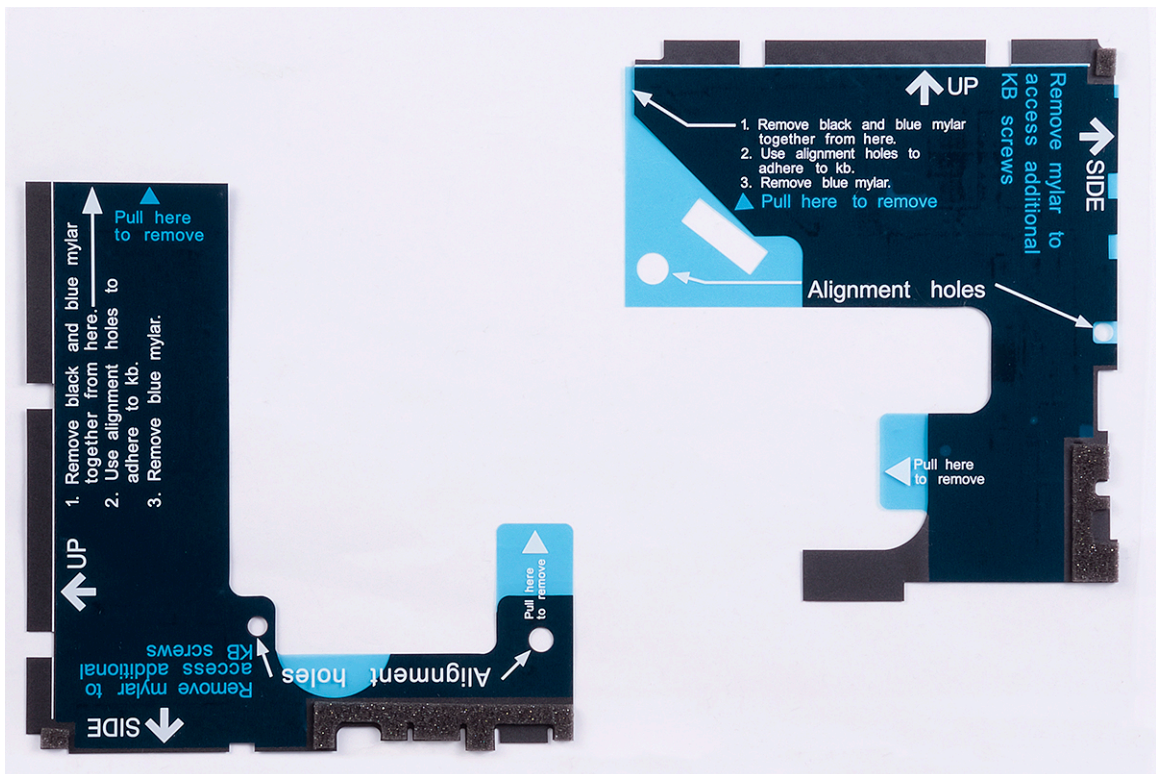

4 Peel the left black Mylar, along with the blue Mylar from the clear release paper.

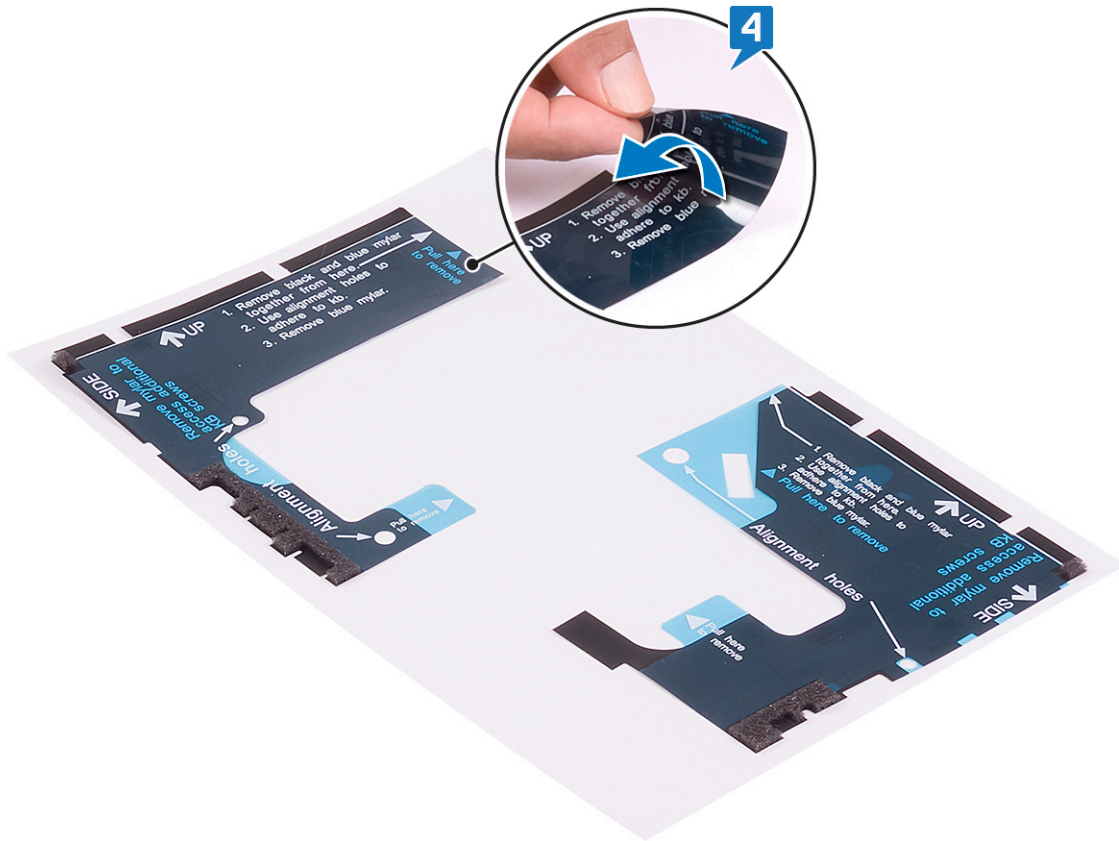

6 Peel the right black Mylar, along with the blue Mylar from the clear release paper.

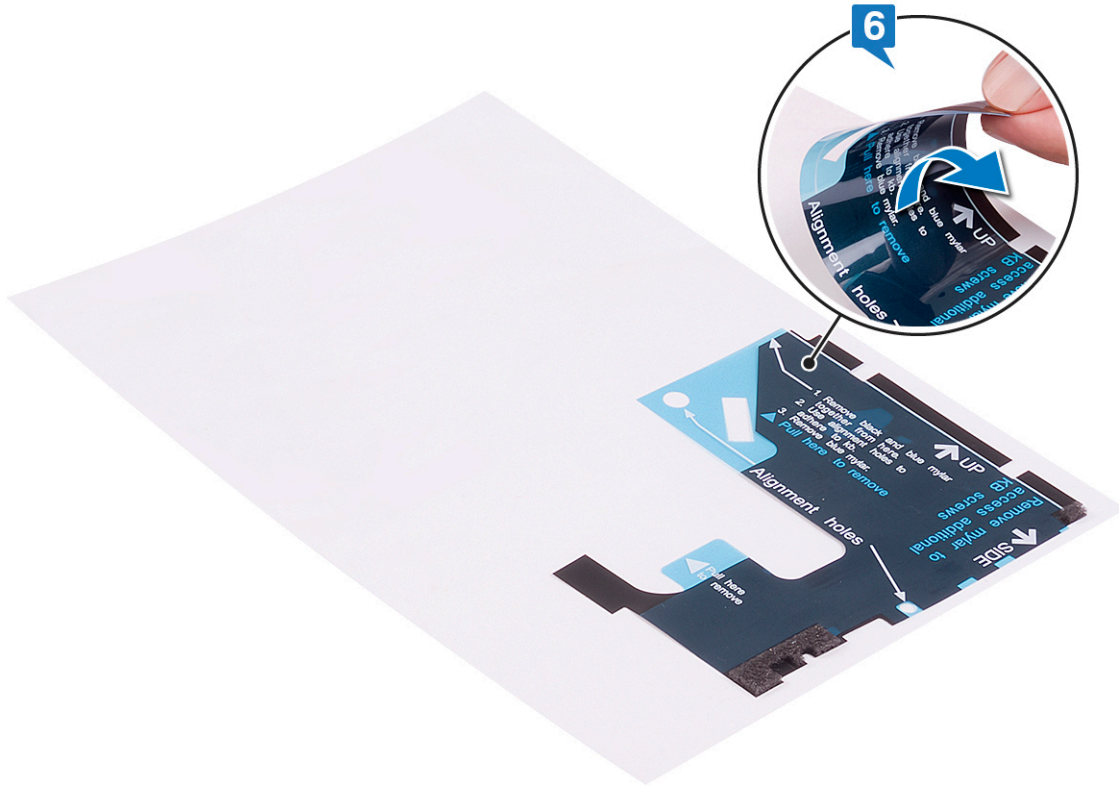

7 Using the alignment holes, adhere the keyboard Mylar on the right side of the keyboard bracket.

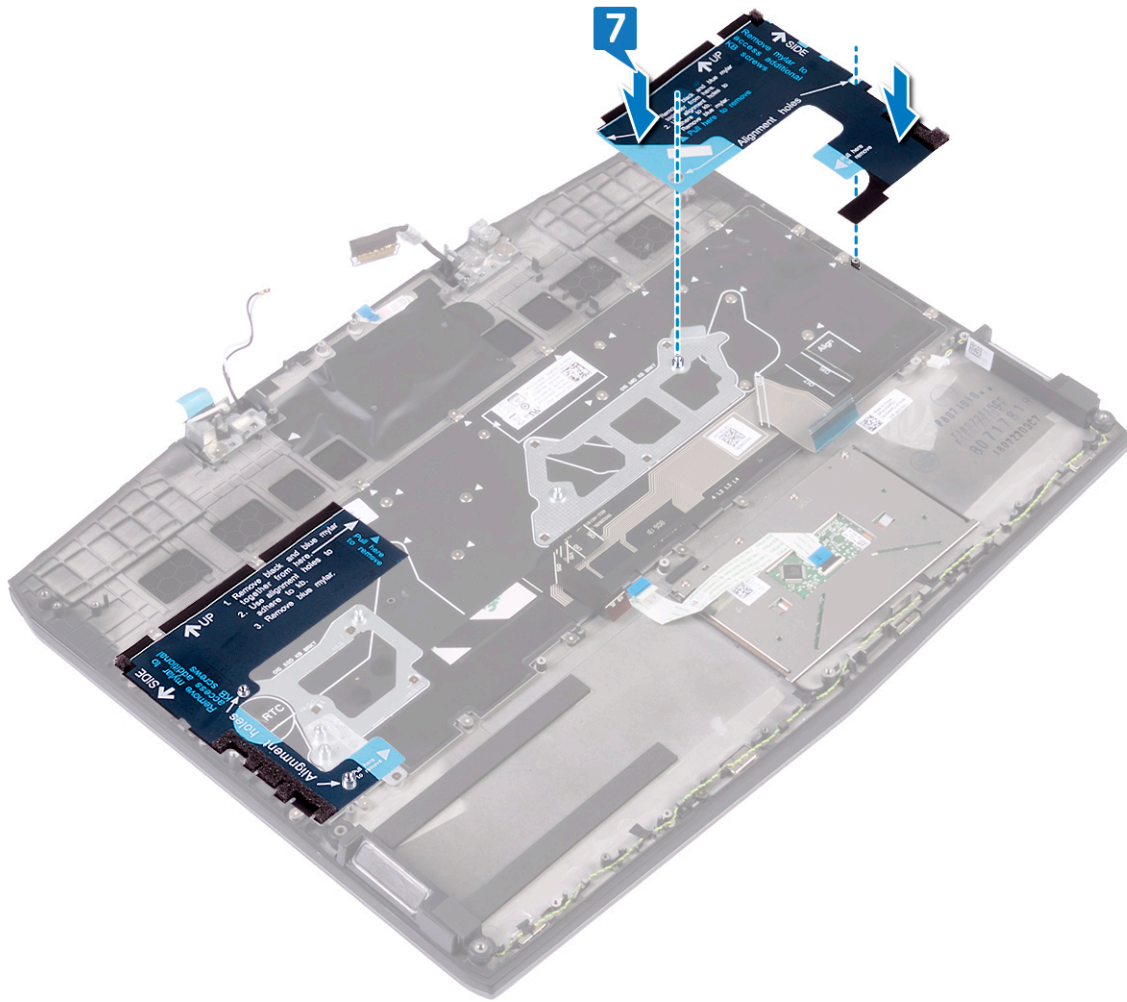

8 Peel the blue Mylar from both the sides.

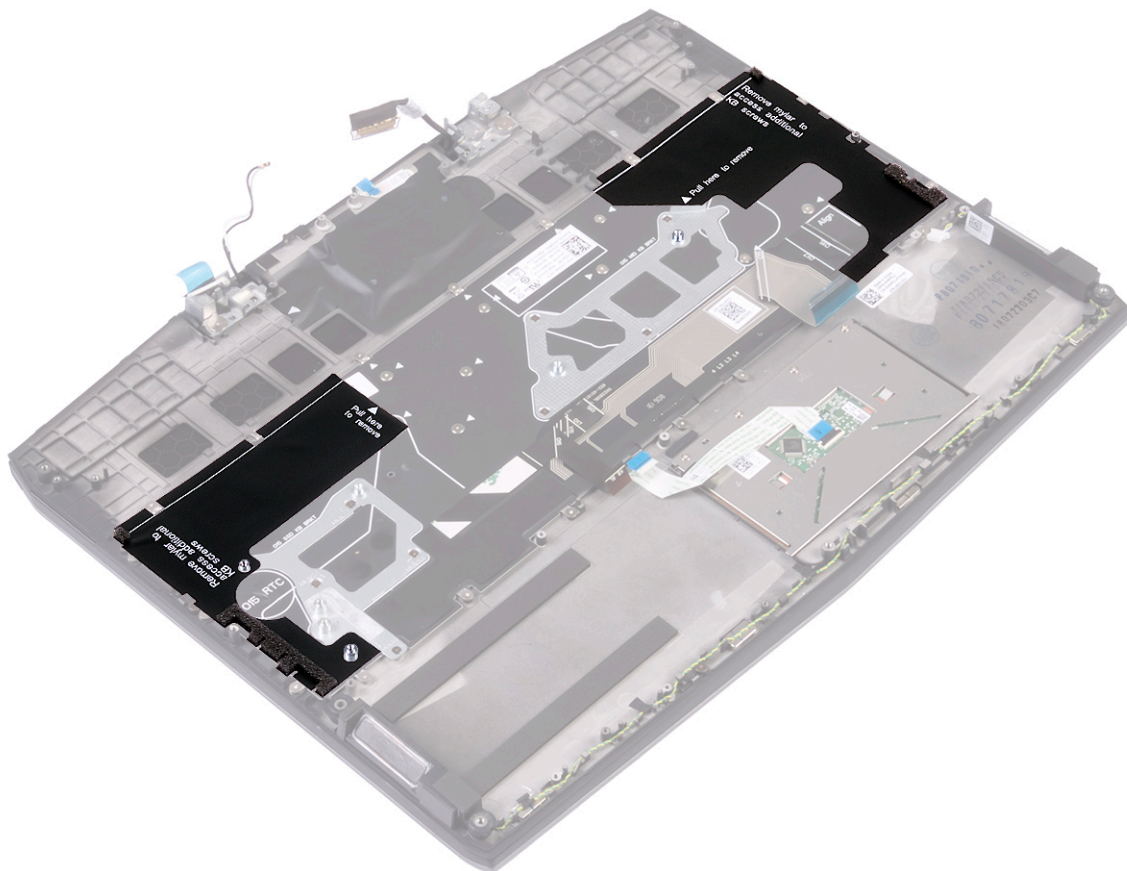
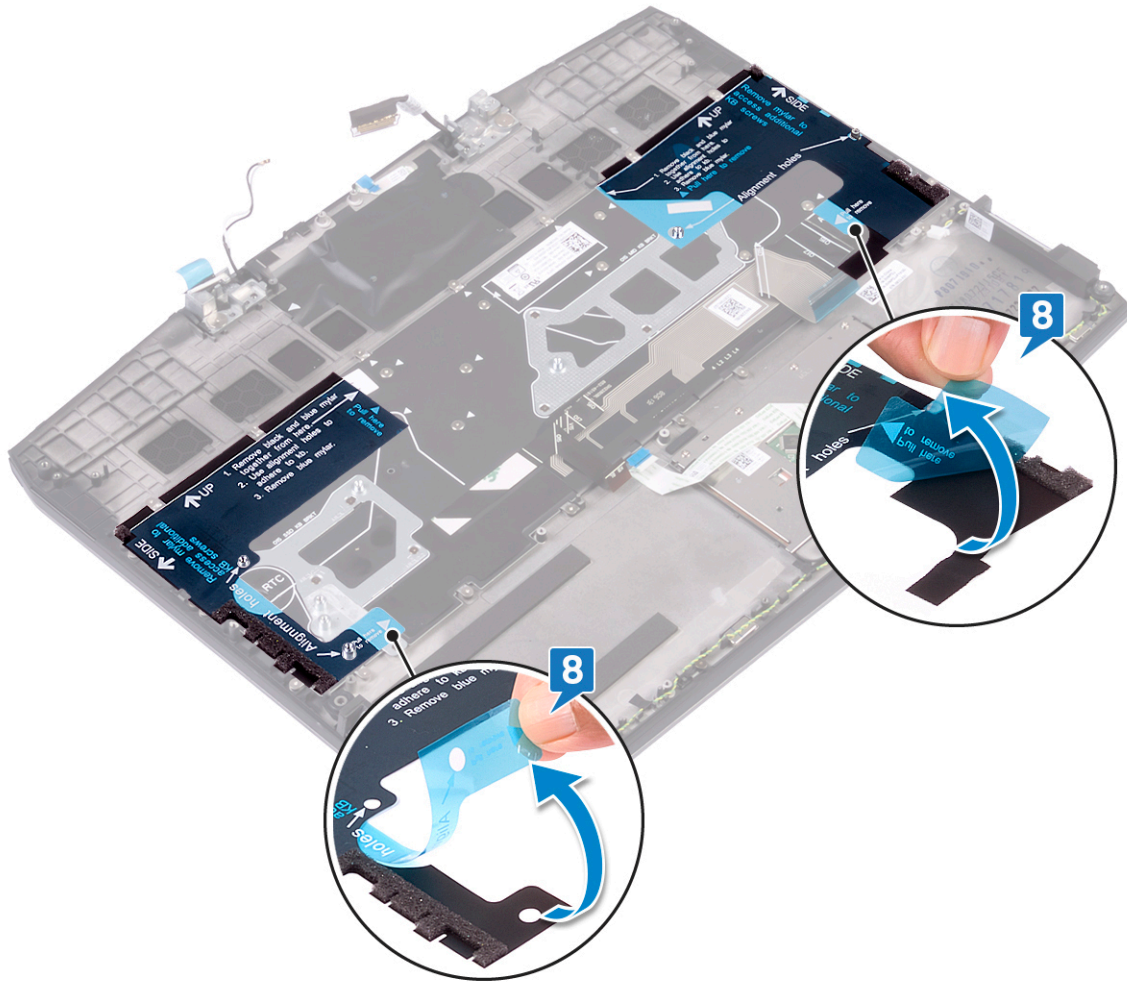

Post-requisites

- 1 Replace the [system board](#).
- 2 Replace the [power-adapter port](#).
- 3 Replace the [coin-cell battery](#).
- 4 Replace the [solid-state drive/Intel Optane](#).
- 5 Replace the [I/O board](#).
- 6 Follow the procedure from step 2 to step 7 in [Replacing the heat sink](#).
- 7 Replace the [wireless card](#).
- 8 Follow the procedure from step 4 to step 6 in [Replacing the hard drive](#).
- 9 Replace the [battery \(half-length\)](#) or the [battery \(full-length\)](#), whichever applicable.
- 10 Replace the [base cover](#).

Removing the palm rest

 **WARNING:** Before working inside your computer, read the safety information that shipped with your computer and follow the steps in [Before working inside your computer](#). After working inside your computer, follow the instructions in [After working inside your computer](#). For more safety best practices, see the Regulatory Compliance home page at www.dell.com/regulatory_compliance.

Prerequisites

- 1 Remove the [base cover](#).
- 2 Remove the [battery \(half-length\)](#) or the [battery \(full-length\)](#), whichever applicable.
- 3 Follow the procedure from step 1 to step 3 in [Removing the hard drive](#).
- 4 Remove the [solid-state drive/Intel Optane](#).
- 5 Remove the [I/O board](#).
- 6 Remove the [coin-cell battery](#).
- 7 Remove the [wireless card](#).
- 8 Follow the procedure from step 1 to step 6 in [Removing the heat sink](#).
- 9 Remove the [speakers](#).
- 10 Remove the [touchpad](#).
- 11 Remove the [power-adapter port](#).
- 12 Remove the [display assembly](#).
- 13 Remove the [system board](#).
- 14 Remove the [power-button board](#).
- 15 Remove the [keyboard](#).

Procedure

After performing the steps in the pre-requisites, we are left with the palm rest.



Replacing the palm rest

WARNING: Before working inside your computer, read the safety information that shipped with your computer and follow the steps in [Before working inside your computer](#). After working inside your computer, follow the instructions in [After working inside your computer](#). For more safety best practices, see the Regulatory Compliance home page at www.dell.com/regulatory_compliance.

Procedure

Place the palm rest on a flat surface.



Post-requisites

- 1 Replace the [keyboard](#).
- 2 Replace the [power-button board](#).
- 3 Replace the [system board](#).
- 4 Replace the [display assembly](#).
- 5 Replace the [power-adapter port](#).
- 6 Replace the [touchpad](#).
- 7 Replace the [speakers](#).
- 8 Follow the procedure from step 2 to step 7 in [Replacing the heat sink](#).
- 9 Replace the [wireless card](#).
- 10 Replace the [coin-cell battery](#).

- 11 Replace the [I/O board](#).
- 12 Replace the [solid-state drive/Intel Optane](#).
- 13 Follow the procedure from step 4 to step 6 in [Replacing the hard drive](#).
- 14 Replace the [battery \(half-length\)](#) or the [battery \(full-length\)](#), whichever applicable.
- 15 Replace the [base cover](#).

Device drivers

Intel Chipset Software Installation Utility

In the Device Manager, check if the chipset driver is installed.

Install the Intel chipset updates from www.dell.com/support.

Video drivers

In the Device Manager, check if the video driver is installed.

Install the video driver update from www.dell.com/support.

Intel Serial IO driver

In the Device Manager, check if the Intel Serial IO driver is installed.

Install the driver updates from www.dell.com/support.

Intel Trusted Execution Engine Interface

In the Device Manager, check if the Intel Trusted Execution Engine Interface driver is installed.

Install the driver update from www.dell.com/support.

Intel Virtual Button driver

In the Device Manager, check if the Intel Virtual Button driver is installed.

Install the driver updates from www.dell.com/support.

Wireless and Bluetooth drivers

In the Device Manager, check if the network card driver is installed.

Install the driver updates from www.dell.com/support.

In the Device Manager, check if the Bluetooth driver is installed.

Install the driver updates from www.dell.com/support.

System setup

 **NOTE:** Depending on the computer and its installed devices, the items listed in this section may or may not be displayed.

BIOS overview

 **CAUTION:** Unless you are an expert computer user, do not change the settings in the BIOS Setup program. Certain changes can make your computer work incorrectly.

 **NOTE:** Before you change BIOS Setup program, it is recommended that you write down the BIOS Setup program screen information for future reference.

Use the BIOS Setup program for the following purposes:

- Get information about the hardware installed in your computer, such as the amount of RAM and the size of the hard drive.
- Change the system configuration information.
- Set or change a user-selectable option, such as the user password, type of hard drive installed, and enabling or disabling base devices.

Entering BIOS setup program

- 1 Turn on (or restart) your computer.
- 2 During POST, when the DELL logo is displayed, watch for the F2 prompt to appear, and then press F2 immediately.

 **NOTE:** The F2 prompt indicates that the keyboard is initialized. This prompt can appear very quickly, so you must watch for it, and then press F2. If you press F2 before the F2 prompt, this keystroke is lost. If you wait too long and the operating system logo appears, continue to wait until you see the desktop. Then, turn off your computer and try again.

Navigation keys

 **NOTE:** For most of the System Setup options, changes that you make are recorded but do not take effect until you restart the system.

Keys	Navigation
Up arrow	Moves to the previous field.
Down arrow	Moves to the next field.
Enter	Selects a value in the selected field (if applicable) or follow the link in the field.
Spacebar	Expands or collapses a drop-down list, if applicable.
Tab	Moves to the next focus area.
	 NOTE: For the standard graphics browser only.
Esc	Moves to the previous page until you view the main screen. Pressing Esc in the main screen displays a message that prompts you to save any unsaved changes and restarts the system.

Boot Sequence

Boot Sequence allows you to bypass the System Setup–defined boot device order and boot directly to a specific device (for example: optical drive or hard drive). During the Power-on Self Test (POST), when the Dell logo appears, you can:

- Access System Setup by pressing F2 key
- Bring up the one-time boot menu by pressing F12 key

The one-time boot menu displays the devices that you can boot from including the diagnostic option. The boot menu options are:

- Removable Drive (if available)
- STXXXX Drive

 **NOTE: XXX denotes the SATA drive number.**

- Optical Drive (if available)
- SATA Hard Drive (if available)
- Diagnostics

 **NOTE: Choosing Diagnostics, will display the ePSA diagnostics screen.**

The boot sequence screen also displays the option to access the System Setup screen.



System setup options

 **NOTE: Depending on your computer and its installed devices, the items listed in this section may or may not appear.**

Table 3. System setup options—Main menu

Main	
System Time	Displays the current time in hh:mm:ss format.
System Date	Displays the current date in mm/dd/yyyy format.
BIOS Version	Displays the BIOS version.
Product Name	Displays the model number of your computer.
Service Tag	Displays the service tag of your computer.
Asset Tag	Displays the asset tag of your computer.
CPU Type	Displays the processor type.
CPU Speed	Displays the processor speed.
CPU ID	Displays the processor identification code.
CPU L1 Cache	Displays the processor L1 cache size.
CPU L2 Cache	Displays the processor L2 cache size.
CPU L3 Cache	Displays the processor L3 cache size.
Integrated Graphics	Displays the integrated graphics.
Discrete Graphics 1	Displays the first discrete graphics installed on your computer.
Discrete Graphics 1	Displays the second discrete graphics installed on your computer.
First HDD	Displays the type of hard drive installed.
M.2 PCIe SSD-1	Displays the type of primary SSD installed.
AC Adapter Type	Displays the AC adapter type.
System Memory	Displays the system memory information.
Memory Speed	Displays the memory speed information.

Table 4. System setup options—Advanced menu

Advanced	
Intel(R) SpeedStep(TM)	Enables you to enable or disable Intel Speedstep Technology. Default: Enabled  NOTE: If enabled, the processor clock speed and core voltage are adjusted dynamically based on the processor load.
Integrated NIC	Enables you to enable or disable the on-board LAN controller. Default: Enabled
USB Emulation	Enables you to enable or disable the USB emulation feature. This feature defines how the BIOS, in the absence of a USB-aware operating system, handles USB devices. USB emulation is always enabled during POST. Default: Enabled  NOTE: You cannot boot any type of USB device (floppy, hard drive, or memory key) when this option is off.
USB Powershare	Enables you to charge USB devices when the computer is turned off or in standby mode. Default: Enabled
USB Wake Support	Enables you to enable the USB devices to wake the computer from Standby. Default: Disabled  NOTE: If USB PowerShare is enabled, a device connected to the USB PowerShare connector may not wake the computer.
Sleep Mode	Enable or disable sleep mode.
Intel Speed Shift Technology	Enable/disable Intel Speed Shift Technology support. Setting this option to enable to allows the operating system to select the appropriate processor performance automatically. Default: Enabled
SATA Operation	Enables you to configure the operating mode of the integrated SATA hard drive controller. Default: AHCI
Adapter Warnings	Enables you to choose if the computer should display warning messages when you use AC adapters that are not supported by your computer. Default: Enabled
Function Key Behavior	Enables you to set function key or multimedia key as the default function key behavior. Default: Function key
Express Charge	Enables you to charge your computer battery using Standard Charge or Express Charge mode. Default: Express Charge
Battery Health	Displays the battery health.
Intel(R) Software Guard Extensions	Enable or disable Intel Software Guard Extensions.

Advanced

	Default: Software Controlled
Intel(R) Software Guard Extensions allocated memory size	Displays the allocated memory size for Intel Software Guard Extensions.
BIOS Recovery from Hard Drive	Enable the user to recover from certain corrupted BIOS conditions from a recovery file on the user primary hard drive Default: Enabled
BIOS Auto-Recovery	Enable or disable BIOS Auto-Recovery. Default: Disabled
SupportAssist System Resolution	
Auto OS Recovery Threshold	Control the automatic boot flow for SupportAssist System Resolution Console and for Dell OS Recovery tool. Default: 2
SupportAssist OS Recovery	Enable or disable SupportAssist OS recovery. Default: Enabled
Intel(R) Rapid Storage Technology	
Non-RAID Physical Disks	Displays the disk using the Intel(R) Rapid Storage Technology.

Table 5. System setup options—Security menu

Security	
Unlock Setup Status	Displays if the setup status is unlocked.
Admin Password Status	Displays if the administrator password is clear or set. Default: Not set
System Password Status	Displays if the system password is clear or set. Default: Not set
HDD Password Status	Displays if the HDD password is clear or set. Default: Not set
Admin Password	Enables you to set the administrator password. The administrator password controls access to the system setup utility.
System Password	Enables you to set the system password. The system password controls access to the computer at boot.
HDD password	Enables you to set, change or delete the hard-disk drive password.
Password Change	Enables you to permit or deny system password or HDD password changes. Default: Permitted
Computrace	Enable or disable the BIOS module interface of the optional Computrace Service from Absolute Software. Default: Activate
Firmware TPM	Enables you to enable or disable the firmware TPM function. Default: Enabled
PPI Bypass for Clear Command	Enables you to control the TPM Physical Presence Interface (PPI). When enabled, this setting will allow the OS to skip

Security

UEFI Capsule Firmware Updates	BIOS PPI user prompts when issuing the Clear command. Changes to this setting take effect immediately. Default: Enabled
	Enable or disable BIOS updates through UEFI capsule update packages. Default: Enabled

Table 6. System setup options—Boot menu

Boot	
Boot List Option	Displays the available boot options. Default: UEFI
File Browser Add Boot Option	Enables you to add the boot options.
File Browser Del Boot Option	Enables you to delete the boot options
Secure Boot	Enable or disable the secure boot feature. Default: Disabled
Legacy Option ROMs	Enable or disable the Legacy Option ROMs. Default: Disabled
Attempt Legacy Boot	Enable or disable Attempt Legacy Boot. Default: Disabled
Boot Option Priorities	Displays the boot sequence.
Boot Option #1	Displays the available first boot option.
Boot Option #2	Displays the available second boot option.
Boot Option #3	Displays the available third boot option.

Table 7. System setup options—Exit menu

Exit	
Save Changes and Reset	Allows you to exit system setup and save your changes.
Discard Changes and Reset	Allows you to exit system setup and load previous values for all system setup options.
Restore Defaults	Allows you to restore default values for all system setup options.
Discard Changes	Allows you to load previous values for all system setup options.
Save Changes	Allows you to save the changes for all system setup options.

Clearing CMOS settings

 **CAUTION: Clearing CMOS settings will reset the BIOS settings on your computer.**

- 1 Remove the [base cover](#).
- 2 Disconnect the battery cable from the system board.
- 3 Remove the [coin-cell battery](#).
- 4 Wait for one minute.
- 5 Replace the [coin-cell battery](#).
- 6 Connect the battery cable to the system board.

7 Replace the [base cover](#).

Clearing BIOS (System Setup) and System passwords

To clear the system or BIOS passwords, contact Dell technical support as described at www.dell.com/contactdell.

 **NOTE:** For information on how to reset Windows or application passwords, refer to the documentation accompanying Windows or your application.

Troubleshooting

Flashing the BIOS

You may need to flash (update) the BIOS when an update is available or when you replace the system board. Follow these steps to flash the BIOS:

- 1 Turn on your computer.
- 2 Go to www.dell.com/support.
- 3 Click **Product support**, enter the Service Tag of your computer, and then click **Submit**.
 **NOTE: If you do not have the Service Tag, use the auto-detect feature or manually browse for your computer model.**
- 4 Click **Drivers & downloads** → **Find it myself**.
- 5 Select the operating system installed on your computer.
- 6 Scroll down the page and expand **BIOS**.
- 7 Click **Download** to download the latest version of the BIOS for your computer.
- 8 After the download is complete, navigate to the folder where you saved the BIOS update file.
- 9 Double-click the BIOS update file icon and follow the instructions on the screen.

Flashing BIOS (USB key)

- 1 Follow the procedure from step 1 to step 7 in "[Flashing the BIOS](#)" to download the latest BIOS setup program file.
- 2 Create a bootable USB drive. For more information see the knowledge base article [SLN143196](#) at www.dell.com/support.
- 3 Copy the BIOS setup program file to the bootable USB drive.
- 4 Connect the bootable USB drive to the computer that needs the BIOS update.
- 5 Restart the computer and press **F12** when the Dell logo is displayed on the screen.
- 6 Boot to the USB drive from the **One Time Boot Menu**.
- 7 Type the BIOS setup program filename and press **Enter**.
- 8 The **BIOS Update Utility** appears. Follow the instructions on the screen to complete the BIOS update.

Enhanced Pre-Boot System Assessment (ePSA) diagnostics

 **CAUTION: Use the ePSA diagnostics to test only your computer. Using this program with other computers may cause invalid results or error messages.**

The ePSA diagnostics (also known as system diagnostics) performs a complete check of your hardware. The ePSA is embedded with the BIOS and is launched by the BIOS internally. The embedded system diagnostics provides a set of options for particular devices or device groups allowing you to:

- Run tests automatically or in an interactive mode
- Repeat tests
- Display or save test results
- Run thorough tests to introduce additional test options to provide extra information about the failed device(s)
- View status messages that inform you if tests are completed successfully
- View error messages that inform you of problems encountered during testing

 **NOTE: Some tests for specific devices require user interaction. Always ensure that you are present at the computer terminal when the diagnostic tests are performed.**

Running the ePSA diagnostics

- 1 Turn on your computer.
- 2 As the computer boots, press the F12 key as the Dell logo appears.
- 3 On the boot menu screen, select the **Diagnostics** option.
- 4 Click the arrow at the bottom left corner.
Diagnostics front page is displayed.
- 5 Click the arrow in the lower-right corner to go to the page listing.
The items detected are listed.
- 6 To run a diagnostic test on a specific device, press Esc and click **Yes** to stop the diagnostic test.
- 7 Select the device from the left pane and click **Run Tests**.
- 8 If there are any issues, error codes are displayed.
Note the error code and validation number and contact Dell.

System diagnostic lights

Power and battery-status light

Indicates the power and battery-charge status

Solid white — Power adapter is connected and the battery has more than 5 percent charge.

Amber — Computer is running on battery and the battery has less than 5 percent charge.

Off

- Power adapter is connected and the battery is fully charged.
- Computer is running on battery and the battery has more than 5 percent charge.
- Computer is in sleep state, hibernation, or turned off

The power and battery-status light blinks amber along with beep codes indicating failures.

For example, the power and battery-status light blinks amber two times followed by a pause, and then blinks white three times followed by a pause. This 2,3 pattern continues until the computer is turned off indicating no memory or RAM is detected.

The following table shows different light patterns and describes what they indicate.

Table 8. Diagnostics

Light pattern	Problem description
2,1	CPU failure
2,2	System board: BIOS and ROM failure
2,3	No memory or RAM detected
2,4	Memory or RAM failure
2,5	Invalid memory installed
2,6	System board or chipset error
2,7	LCD failure
3,1	CMOS battery failure
3,2	PCI or video card or chip failure
3,3	Recovery image not found
3,4	Recovery image found but invalid

Camera status light: Indicates whether the camera is in use.

- Solid white — Camera is in use.

- Off — Camera is not in use.

Caps Lock status light: Indicates whether Caps Lock is enabled or disabled.

- Solid white — Caps Lock enabled.
- Off — Caps Lock disabled.

Enabling Intel Optane memory

- 1 On the taskbar, click the search box, and then type `Intel Rapid Storage Technology`.
- 2 Click **Intel Rapid Storage Technology**.
The **Intel Rapid Storage Technology** window is displayed.
- 3 On the **Status** tab, click **Enable** to enable the Intel Optane memory.
- 4 On the warning screen, select a compatible fast drive, and then click **Yes** to continue enabling Intel Optane memory.
- 5 Click **Intel Optane memory** → **Reboot** to complete enabling your Intel Optane memory.

 **NOTE:** Applications may take up to three subsequent launches after enablement to see the full performance benefits.

Disabling Intel Optane memory

 **CAUTION:** After disabling Intel Optane memory, do not uninstall the driver for Intel Rapid Storage Technology as it will result in a blue screen error. The Intel Rapid Storage Technology user interface can be removed without uninstalling the driver.

 **NOTE:** Disabling Intel Optane memory is required before removing the SATA storage device accelerated by the Intel Optane memory module from the computer.

- 1 On the taskbar, click the search box, and then type `Intel Rapid Storage Technology`.
- 2 Click **Intel Rapid Storage Technology**.
The **Intel Rapid Storage Technology** window is displayed.
- 3 On the **Intel Optane memory** tab, click **Disable** to disable the Intel Optane memory.

 **NOTE:** For computers in which Intel Optane memory acts as a primary storage, do not disable the Intel Optane memory. The **Disable** option will be grayed out.

- 4 Click **Yes** if you accept the warning.
The disabling progress is displayed.
- 5 Click **Reboot** to complete disabling your Intel Optane memory and restart your computer.

WiFi power cycle

If your computer is unable to access the internet due to WiFi connectivity issues a WiFi power cycle procedure may be performed. The following procedure provides the instructions on how to conduct a WiFi power cycle:

 **NOTE:** Some ISPs (Internet Service Providers) provide a modem/router combo device.

- 1 Turn off your computer.
- 2 Turn off the modem.
- 3 Turn off the wireless router.
- 4 Wait for 30 seconds.
- 5 Turn on the wireless router.
- 6 Turn on the modem.
- 7 Turn on your computer.

Flea power release

Flea power is the residual static electricity that remains on the computer even after it has been powered off and the battery has been removed. The following procedure provides the instructions on how to conduct flea power release:



- 1 Turn off your computer.
- 2 Disconnect the power adapter from your computer.
- 3 Press and hold the power button for 15 seconds to drain the flea power.
- 4 Connect the power adapter to your computer.
- 5 Turn on your computer.

Getting help and contacting Alienware

Self-help resources



You can get information and help on Alienware products and services using these online self-help resources:

Table 9. Alienware products and online self-help resources

Self-help resources	Resource location
Information about Alienware products and services	www.alienware.com
My Dell	
Tips	
Contact Support	In Windows search, type Contact Support , and press Enter .
Online help for operating system	www.dell.com/support/windows www.dell.com/support/linux
Troubleshooting information, user manuals, setup instructions, product specifications, technical help blogs, drivers, software updates, and so on	www.alienware.com/gamingservices
VR Support	www.dell.com/VRsupport
Videos providing step-by-step instructions to service your computer	www.youtube.com/alienwareservices

Contacting Alienware

To contact Alienware for sales, technical support, or customer service issues, see www.alienware.com.

-  **NOTE: Availability varies by country/region and product, and some services may not be available in your country/region.**
-  **NOTE: If you do not have an active Internet connection, you can find contact information about your purchase invoice, packing slip, bill, or Dell product catalog.**