



## OWNER'S MANUAL

# WASHING MACHINE

---



Before beginning installation, read these instructions carefully. This will simplify installation and ensure that the product is installed correctly and safely. Leave these instructions near the product after installation for future reference.

### EN ENGLISH

FHV1409#WW/L/S/B/P

FHV1408#WW/L/S/B/P

#: Z / Y / X / H



MFL71716230  
Rev.00\_151220

[www.lg.com](http://www.lg.com)

Copyright © 2020 LG Electronics Inc. All Rights Reserved.

# Product Features



- **Protection against creases**  
With the alternate rotation of the drum, creasing in the laundry is minimized.



- **Built-in heater**  
Internal heater automatically heats the water to the best temperature on selected cycles.



- **More economical by Intelligent Wash System**  
Intelligent Wash System detects the amount of load and water temperature, and then determines the optimum water level and washing time to minimize energy and water consumption.



- **Child Lock**  
The Child lock prevents children from changing the settings, if they press any button during operation.



- **Low noise speed control system**  
By sensing the amount of load and balance, it evenly distributes load to minimize the spinning noise level.



- **Auto Restart**  
Auto Restart allows the program to restart all by itself in case of power failure. It does from the stage where it stopped.



MOTION

- **6 Motion**  
Washer is able to perform various drum actions or a combination of different actions depending on the wash program selected. Combined with a controlled spin speed and the ability of the drum to rotate both left and right, the wash performance of the machine is greatly improved, giving you perfect results every time.



- **Direct Drive System**  
The advanced Brushless DC motor directly drives the drum without belt and pulley.

\* This Manual may contain images or content different from the model you purchased.

\* This Manual is subject to revision by the manufacturer.

# Contents

Safety Information .....	3
Specifications .....	4
Installation .....	5
Care before washing .....	11
Adding detergent .....	12
Function .....	14
How to use washer .....	15
Smart Functions .....	22
Maintenance .....	25
Troubleshooting guide .....	29
Terms of Warranty .....	33



# safety Information

READ ALL INSTRUCTIONS AND EXPLANATION OF THE INSTALLATION BEFORE USE



## WARNING

For your safety, the information in this manual must be followed to minimize the risk of fire or explosion, electric shock, or to prevent property damage, personal injury, or loss of life.



## WARNING

### IMPORTANT SAFETY INSTRUCTIONS

To reduce the risk of fire, electric shock, or injury to persons when using the washer, follow basic precautions, including the following:

- **Before installation, check exterior damages. If it has, do not install.**
- **Do not install or store the washer where it will be exposed to the weather (Rain / Water Splash).**  
If the product is exposed to such conditions, electric shock, fire, break down or deformation may occur.
- **Do not tamper with controls.**  
It may lead to electric shock, fire, break down or deformation.
- **Do not repair or replace any part of the washer or attempt any servicing unless specifically recommended in the user-maintenance instructions or published user-repair instructions that you understand and have the skills to carry out.**  
Operating the machine with improperly replaced parts may be a cause for fire or electric shock.
- **Keep the area underneath and around your appliances free of combustible materials such as lint, paper, rags, chemicals, etc.**  
Operating with such materials around the machine may trigger explosion or fire.
- **Close supervision is necessary if this appliance is used by or near children. Do not allow children to play on, with, or inside this or any other appliance.**  
There is a potential danger that children might drown in the tub.
- **Keep small animals away from the appliance.**
- **Do not leave the washer door open. An open door could entice children to hang on the door or crawl inside the washer.**
- **Never reach into washer while it is moving. Wait until the drum has completely stopped.**  
Even slow rotation can cause injury.
- **The laundry process can reduce the flame retardant of fabrics. To avoid such a result, carefully follow the garment manufacturer's wash and care instructions.**
- **Do not wash or dry articles that have been cleaned in, washed in, soaked in, or spotted with combustible or explosive substances (such as wax, oil, paint, gasoline, degreasers, dry-cleaning solvents, kerosene, etc.).**  
It may ignite or explode. Oil may remain in the tub after a whole cycle resulting in fire during drying.  
So, do not load oiled clothes.
- **Do not slam the washer door closed or try to force the door open when locked.**  
This could result in damage to the washer.
- **When the machine runs high temperature, the front door may be very hot. Don't touch it.**
- **To minimize the possibility of electric shock, unplug this appliance from the power supply or disconnect the washer from the household distribution panel by removing the fuse or switching off the circuit breaker before attempting any maintenance or cleaning.**
- **When unplugging power cord, do not pull out by grasping the cord.**  
Otherwise, the power cord may be damaged.
- **Never attempt to operate this appliance if it is damaged, malfunctioning, partially disassembled, or has missing or broken parts, including a damaged cord or plug.**  
Operating with a damaged plug may cause electric shock.
- **Before discarding an old machine unplug it. Render the plug useless. Cut off the cable directly behind the appliance to prevent misuse.**
- **When a product was under water, Please call service center. The risk of electric shock and fire.**
- **When washer door is opened, do not push down the door excessively.**  
This could topple over the washer.

### GROUNDING INSTRUCTIONS

This appliance must be grounded. In the event of malfunction or breakdown, grounding will reduce the risk of electric shock by providing a path of least resistance for electric current. This appliance is equipped with cord having an equipment-grounding conductor and grounding plug. The plug must be plugged into an appropriate outlet that is properly installed and grounded in accordance with all local codes & ordinance.

- Do not use an adapter or otherwise defect the grounding plug.
- If you don't have the proper outlet, consult an electrician.



## WARNING

Improper connection of the equipment-grounding conductor can result in risk of electric shock. Check with a qualified electrician or serviceman if you are indoubt the plug provided with the appliance-if it does not fit the outlet, have a proper outlet installed by a qualified electrician as to whether the appliance is properly grounded. Do not modify the plug provided with the appliance-if it does not fit the outlet, have a proper outlet installed by a qualified electrician.

# S pecifications

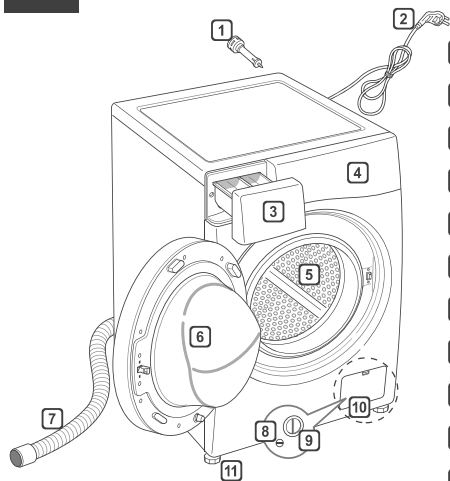

- 1 Transit bolts
- 2 Power plug
- 3 Drawer\*
- 4 Control panel\*
- 5 Drum
- 6 Door\*
- 7 Drain hose
- 8 Drain plug
- 9 Drain pump filter
- 10 Cap Cover
- 11 Adjustable Leg

## Product dimension(mm)

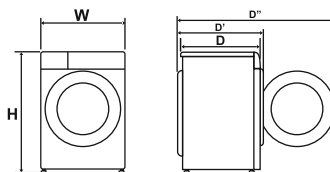

W	600mm	D	565mm	H	850mm
D'	615mm	D''	1100 mm		

- Name : Front loading washing machine
- Power supply : 230V~,50Hz
- Weight/Max.Watt : 63kg / 2100W
- Wash capacity : 9.0kg : [FHV1409#WW/L/S/B/P]  
8.0kg : [FHV1408#WW/L/S/B/P]
- Spin speed (RPM) : No/400/800/1000/1200/1400: [FHV1409#WW/L/S/B/P,  
FHV1408#WW/L/S/B/P]
- Permissible water pressure : 50-800kPa (0.5-8kgf/cm<sup>2</sup>)

- The appearance and specifications may be varied without notice to raise the product quality.

## Accessories

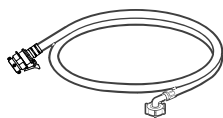

Inlet hose\*(1EA)

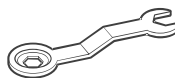

Spanner(1EA)

\* Part can be different according to different models.

# Installation

Install or store where it will not be exposed to temperatures below freezing or exposed to the weather. Properly ground washer to conform with all governing codes and ordinances.

The base opening must not be obstructed by carpeting when the washing machine is installed on a carpeted floor.

In countries where there are areas which may be subjected to infestation by cockroaches or other vermin, pay particular attention in keeping the appliance and its surroundings in clean condition at all times. Any damage which may be caused by cockroaches or other vermin will not be covered by the appliance guarantee.

## ■ Transit bolts

The appliance is fitted with transit bolts to prevent internal damage during transport.

- Packing and all transit bolts must be removed before using the Machine.

## ■ Removing transit bolts

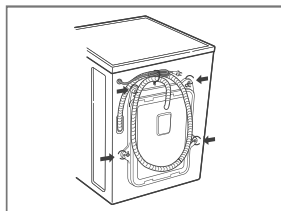

1. To prevent internal damage during transport, the special 4 bolts are locked. Before operating the washer, remove the bolts along with the rubber bungs.

- If they are not removed, it may cause heavy vibration, noise and malfunction.

2. Unscrew the 4 bolts with the spanner supplied.

3. Take out the 4 bolts along with the rubber bungs by slightly twisting the bung. Keep the 4 bolts and the spanner for future use.

- Whenever the appliance is transported, the transit bolts must be refitted.

4. Close the holes with the caps supplied.

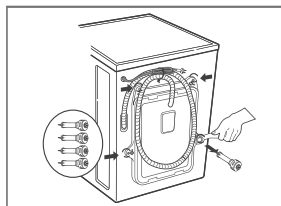

# I nstallation

## ■ Installation place requirement

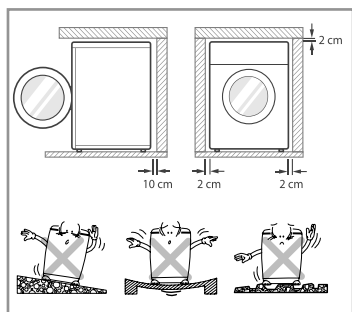

### Level floor :

Allowable slope under entire washer is 1°

### Power outlet :

Must be within 1 meter of either side of location of washer. Do not overload the outlet with more than one appliance.

### Additional Clearance :

For wall, door and floor modeling is required.

(10cm : rear /2cm:right & left side)

Do not place or store laundry products on top of washer at any times.

They can damage the finish or controls.

## ■ Positioning

- Install the washer on a flat hard floor.
- Make sure that air circulation around the washer is not impeded by carpets, rug etc.
- Never try to correct any unevenness in the floor with pieces of wood, cardboard or similar materials under the washer.
- If it is impossible to avoid positioning the washer next to a gas cooker or coal burning stove, an insulating (85x60cm) covered with aluminum foil on the side facing the cooker or stove, must be inserted between the two appliances.
- Do not install the appliance in rooms where freezing temperatures may occur. Frozen hoses may burst under pressure. The reliability of the electronic control unit may be impaired at temperatures below freezing point.
- Please ensure that when the washer is installed, it is easily accessible for the engineer in the event of a breakdown.
- With the washer installed adjust all four adjustable legs using the transit bolt spanner provided ensuring the appliance is stable, and a clearance of approximately 20 mm is left between the top of the washer and the underside of the work-top.

## ⚠ WARNING

It is advisable to avoid, the usage of trolley & the movement of Washing Machine after installation. As it may disturb the levelling of washer, which can create excessive noise & vibration.

# Installation

## ■ Electrical connection

1. Do not use an extension cord or double adapter.
  2. If the supply cord is damaged, it must be replaced by the manufacturer or its service agents or equally qualified person in order to avoid a hazard.
  3. Always unplug the machine and turn off the water supply after use.
  4. Connect the machine to an earthed socket in accordance with current wiring regulations.
  5. The appliance must be positioned so that the plug is easily accessible.
- Repairs to the washing machine must only be carried out by qualified personnel. Repairs carried out by inexperienced persons may cause injury or serious malfunctioning. Contact your local service center.
  - Do not install your washing machine in rooms where temperature below freezing may occur. Frozen hoses may burst under pressure. The reliability of the electronic control unit may be impaired at temperatures below freezing point.
  - If the appliance is delivered in the winter months and temperatures are below freezing : Place the washing machine at room temperature for a few hours before putting it into operation.

## ⚠ CAUTION

The appliance is not intended for use by young children or infirm persons without supervision. Young children should be supervised to ensure that they do not play with appliance.

## ⚠ CAUTION

### CAUTION concerning the Power Cord

Most appliances recommend they be placed upon a dedicated circuit; that is, a single outlet circuit which powers only that appliance and has no additional outlets or branch circuits. Check the specification page of this owner's manual to be certain.

Do not overload wall outlets. Overloaded wall outlets, loose or damaged wall outlets, extension cords, frayed power cords, or damaged or cracked wire insulation are dangerous. Any of these conditions could result in electric shock or fire. Periodically examine the cord of your appliance, and if its appearance indicates damage or deterioration, unplug it, discontinue use of the appliance, and have the cord replaced with an exact replacement part by an authorized service Centre.

Protect the power cord from physical or mechanical abuse, such as being twisted, kinked, pinched, closed in a door, or walked upon. Pay particular attention to plugs, wall outlets, and the point where the cord exits the appliance.

## ■ Washing Machine is to be connected to the water mains using new hose-sets and old hose-sets should not be used.

### ■ Connecting water supply hose\*

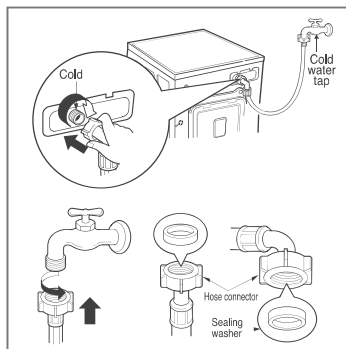

- ▶ Water supply pressure must be between 50kPa and 800kPa (0.5~8 kgf/cm<sup>2</sup>)
- ▶ Don't strip or crossthread when connecting Inlet hose to the valve.
- ▶ If the water supply pressure is more than 800kPa, a decompression device should be installed.
- Two rubber seals are supplied with the water inlet hoses. They are used for preventing water leaks.
- Make sure the connection to taps is tight enough.
- Periodically check the condition of the hose and replace the hose if necessary.
- Make sure that there is no kink on the hose and that it is not crushed.

**NOTE** After completing connection, if water leaks from the hose, repeat the same steps. Use the most conventional type of faucet for water supply. In case the faucet is square or too big, remove the spacing ring before inserting the faucet into the adaptor.

\* Part can be different according to different models.

# Installation

## ■ Normal Tap without thread & screw type inlet hose

1. Unscrew the fixing screw to attach the tap.

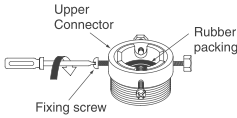

2. Push the connector up till the rubber packing is in tight contact with the tap. Then tighten the 4 screws.

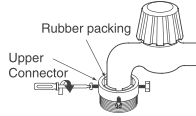

3. Push the water supply hose vertically upwards so that the rubber packing within the hose can adhere completely to the tap and then tighten it by screwing it to the right.

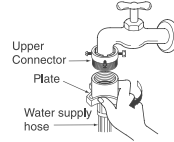

## ■ Normal Tap without thread & one touch type inlet hose (Single inlet models)

1. Untighten the upper connector screw.

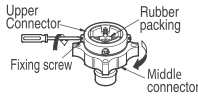

2. Push the upper connector up till the rubber packing is in tight contact with the tap. Then tighten the 4 screws.

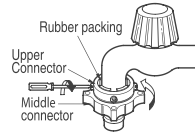

3. Connect the water supply hose to the middle connector, pushing the plate down.

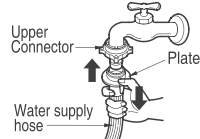

• In case the diameter of the tap is large remove the guide plate.

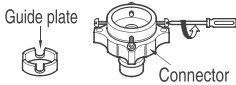

• Turn the middle connector not to have water leaked.  
• Make sure that the rubber seal is inside the hose connector.

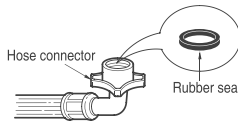

• To separate the water supply hose from the middle connector shut off the tap. Then pull the inlet hose down, pushing the plate down.

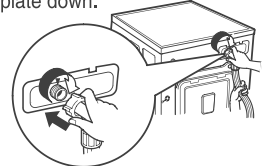

• Your machine comes with only cold water connection.  
• Make sure that there are no kinks in the hose and that it is not crushed.

### Use the horizontal tap

Horizontal tap



Extension tap



Square tap



## ■ Tap with thread & screw type inlet hose

1. • Two rubber seals are provided with inlet hose connectors.  
• These are used to prevent water leakage.  
• Make sure the connection to tap is sufficiently tight.

2. Check rubber seals in inlet hose connectors.

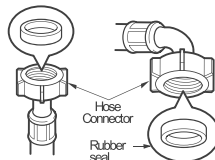

3. Screw the hose connector onto water supply tap.

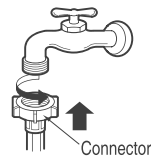



# Installation

This appliance is not designated for maritime use or for use mobile installations such as caravans, aircraft etc. This appliance is intended to be used in household only.

Turn off the stopcock if the machine is to be left for any length of time (e.g. holiday), especially if there is no floor drain(gully) in the immediate vicinity.

When disposing of the appliance, cut off the mains cable and destroy the plug. Break the door lock to prevent young children being trapped inside.

Packaging material (e.g. Films, Styrofoam, PE Bags) can be dangerous for children. There is a risk of suffocation !

Keep all packaging well away from children.

## ■ Installation of drain hose

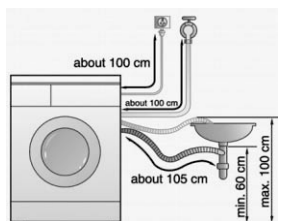

- The drain hose should not be placed higher than 100 cm above the floor.
- Proper securing of the drain hose will protect the floor from getting wet due to water leakage.
- When the drain hose is too long, do not force back into the washer. This will cause abnormal noise/leakage.

# Installation

## ■ Level adjustment



1. Adjusting the washing machine level properly prevents excessive noise and vibration.  
Install the appliance on a solid and level floor surface, preferably in a corner of the room.

**NOTE** Timber or suspended type flooring may contribute to excessive vibration and unbalance errors.

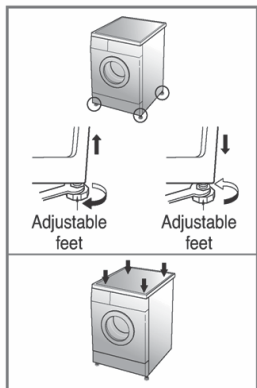

2. If the floor is uneven, adjust the adjustable leg as required. (do not insert pieces of wood etc. under the legs)  
Make sure that all four legs are stable and resting on the floor and then check that the appliance is perfectly level. (use a spirit level)

※ *After the washer is levelled, tighten all lock nuts up towards the base of the washer.*

**NOTE** In the case the washing machine is installed on a raised platform, it must be securely fastened in order to eliminate the risk that it might fall off.

### ※ **Diagonal Check**

*When pushing down the edges of the washing machine top plate diagonally, the machine should not move up and down at all. (Please, check both of two directions)*

*If machine rocks when pushing the machine top plate diagonally, adjust the legs again.*

## ■ Concrete floors

- The installation surface must be clean, dry and level.
- Install washer on a flat hard floor.

## ■ Tile/Granite floors (Slippery Floors)

- Clean the floor to remove dirt, foreign objects and moisture (If floor is wet or not clean, anti-skid pads may not stick properly on the floor) and then adjust the adjustable legs as required.
- Place the adhesive side(B) of anti-skid pad on the floor. It is most effective to install anti-skid pad under the front legs.
- Ensure the washing machine is levelled. If washing machine still have seesaw, adjust the level again.

※ *Anti-Skid pad (p/no.MHK61866301) is a consumable part, and it can be obtained from LG spares dept.*

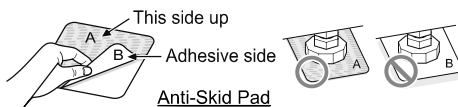

Anti-Skid Pad

## ■ Wooden floors (Suspended floors)

- Wooden floors are particularly susceptible to vibration.
- To prevent vibration we recommend you place rubber cups under each leg, at least 15mm thick under the washer, secured to at least 2 floor beams with screws.
- If possible, install the washer in one of the corners of the room, where the floor is more stable.

※ *You can obtain the rubber cups (p/no.4620ER4002B) from the LG spares dept.*

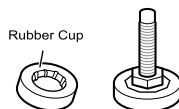

Rubber Cup

### Important!

- Proper placement and levelling of the washer ensure long, regular and reliable operation.
- The washer must be absolutely horizontal and stand firmly in position.
- It must not "Seesaw" across corners under load.
- The installation surface must be clean, free from floor wax and other lubricant coatings.
- Do not let the legs of the washer get wet. If legs of the washer get wet, slipping may occur.

# Care before washing

## ■ Before the first washing

Select a cycle (Cotton 60°C, add a half load of detergent) allow the unit to wash without clothing. This will remove residues and water from the drum that may have been left during manufacturing.

## ■ Caring before washing

### 1. Care Labels

Look for a care label on your clothes. This will tell you about the fabric content of your garment and how it should be washed.

### 2. Sorting

To get the best results, Sort clothes into loads that can be washed with the same wash cycle. Water temperature and spin speed and different fabrics need to be washed in different ways. Always sort dark colors from pale colors and whites. Wash separately as dye and lint transfer can occur causing discoloration of white etc. If possible, do not wash heavily soiled items with lightly soiled one.

- |   |   |
|---|---|
| Soil (Heavy, Normal, Light) .....       | Separate clothes according to amount of soil.       |
| Color (White, Lights, Darks) .....      | Separate white fabrics from colored fabrics.        |
| Lint (Lint producers, Collectors) ..... | Wash lint producers and lint collectors separately. |

### 3. Caring before loading

- **Combine large and small items in a load. Load large items first. Large items should not be more than half the total wash load.**

**Do not wash single items. This may cause an out-of-balance load. Add one or two similar items.**



- Check all pockets to make sure that they are empty. Items such as nails, hair clip, matches, pens, coins and keys can damage both your washer and your clothes.

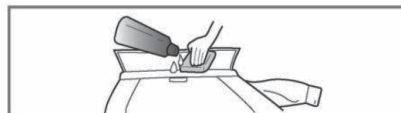

- Pre treat dirt and stains by brushing a little detergent dissolved in water onto stains like collars and cuffs to help shift dirt.



- Close zippers, hooks and strings to make sure that these items don't snag on other clothes.

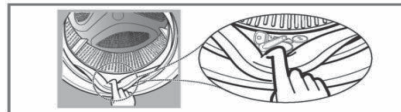

- Check the folds of the flexible gasket (gray) and remove any small articles, if any.

- Check inside of the drum and remove any left items in it for next wash cycle.



- Remove any clothing or items on the flexible gasket to prevent clothing and the gasket damages.

# Adding detergent

## ■ Adding detergent and fabric softener

### 1. The Dispenser Drawer

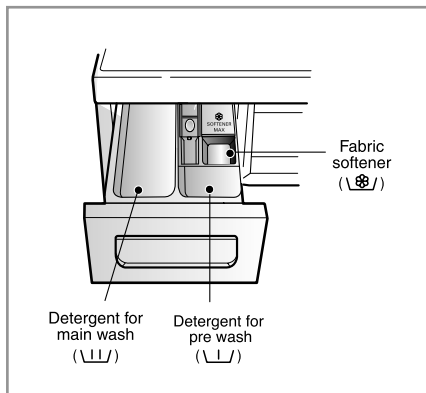

- Main wash only → \ \ /
- Pre Wash + Main Wash → \ \ / • \ \ /

#### **⚠ WARNING**

Keep all washing detergents away from children as there is danger of poisoning. Too much detergent, bleach or softener may cause an overflow. Be sure to use the appropriate amount of detergent.

### 2. Adding Fabric Softener

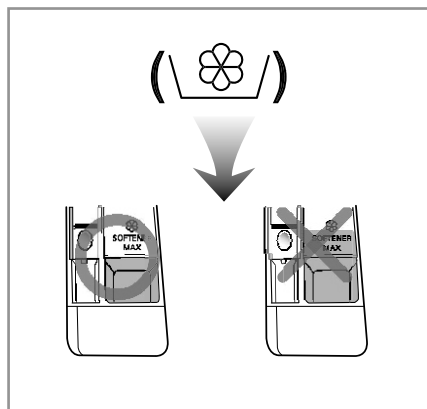

- Do not exceed the maximum fill line. Close the dispenser drawer slowly. Overfilling can cause early dispensing of the fabric softener which could stain clothes.
- Do not leave the fabric softener in the detergent drawer for more than 2 days. (Fabric softener could harden)
- Softener will be automatically added during the last rinse cycle.
- Do not open the drawer when water is supplied.
- Solvents (benzene etc) are not allowable.

**NOTE** Do not pour fabric softener directly on the cloths

# A dding detergent

## 3. Detergent dosage

- The detergent should be used according to the instruction of the detergent manufacturer.
  - If too much detergent is used, too many suds can occur and this will decrease the washing result or cause heavy load to the motor.
  - It is recommended that you use powdered detergent for best results.
  - If you wish to use liquid detergent follow guidelines provided by the detergent manufacturer.
  - You can pour liquid detergent directly in to the main detergent drawer if you are starting the cycle immediately.
  - Please do not use liquid detergent if you are using 'Delay end' as the liquid may harden, or if you have selected 'Pre-Wash'.
- \* If too much suds occur, please reduce the detergent amount.
- Detergent usage may need to be adjusted for water temperature, water hardness, size and soil level of the load. For best results, avoid oversudsing.

### ⚠ WARNING

Do not let the detergent harden.  
Doing so may lead to blockages, poor rinse performance or bad odor.

#### NOTE

- Full load : according to manufacturer's recommendation.
- Part load : 3/4 of the normal amount.
- Minimum load : 1/2 of full load.

- Detergent is flushed from the dispenser at the beginning of the cycle.

## 4. Adding water softener



- A water softener, such as Anti limescale can be used to cut down on the use of detergent in extremely hard water areas. Dispense according to the amount specified on the packaging. First add detergent and then the water softener.
- Use the quantity of detergent as for soft water.

## 5. Using the Tablets

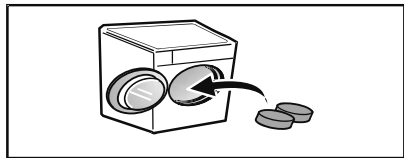

- 1) Open the door and put tablets into the drum.

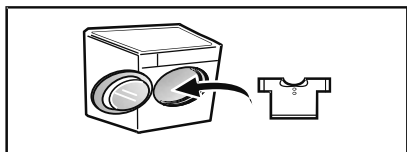

- 2) Load the laundry into the drum and close the door.

## ■ Recommended courses according to the laundry type

Program	Description	Fabric Type	Proper Temp.	Maximum Load
Cotton	Provides better performance by combining various drum motions.	Coloured fast garments (shirts, night-dresses, pajamas, etc.) and normally soiled cotton load (underwear).	40 °C (Cold to 95 °C)	Rating
Cotton+□	Provides optimised washing performance for large amount of laundry		60 °C (Cold to 60 °C)	
Easy Care	Suitable for casual shirts that do not need ironing after washing.	Polyamide, acrylic, polyester.	40 °C (Cold to 60 °C)	4 kg
Mixed Fabric	Enables various fabrics to be washed simultaneously.	Various kind of fabrics except special garments (silk/delicate, sports wear, dark clothes, wool, duvet/curtains).		
Allergy Care	Helps to remove allergens such as house mites, pollen and cat fur.	Cotton, underwear, pillow covers, bed sheets, baby wear.		
Duvet	For large items such as bed covers, pillows, sofa covers, etc.	Cotton bedding except special garments (delicates, wool, silk, etc.) with filling: duvets, pillows, blankets, sofa covers with light filling.	Cold (Cold to 40°C)	2.5kg (1 down duvet)
Sportswear	Suitable for sports wear such as jogging clothes and running wear.	Coolmax, gore-tax, fleece and sympatex	40°C (Cold to 40°C)	2 kg
Baby Steam Care	Washes baby clothes with gentle motion and better performance.	Lightly soiled baby wear.	60 °C	4 kg
TurboWash 59	Finishes the whole cycle within 59 minutes without compromising washing performance and fabric care.	Various kind of fabrics except special garments (silk/delicate, sports wear, dark clothes, wool, duvet/curtains).	40 °C (Cold to 60 °C)	5 kg
Delicates	For delicate clothes such as underwear, blouse etc.	Delicate, easily damaged laundry	20 °C (Cold to 40 °C)	1.5 kg
Speed 14	This cycle provides fast washing time for small loads and lightly soiled clothes.	Coloured laundry which is lightly soiled fast. CAUTION: Use less than 20g of detergent (for 2kg load) otherwise detergent may remain on the clothes.	20°C (20°C to 40°C)	2 kg
Hand/Wool	For hand and machine washable delicate clothes such as washable wool, lingerie, dresses etc. (Use detergent for machine washable wools).	Wool, Silk, hand washable clothes, delicate, easily damaged laundry.	30 °C (Cold to 40°C)	2 kg
Tub Clean	This is a special function to clean inside of your appliance.			
Download Cycle	For downloadable programs. If you did not download any program, the default is Rinse+Spin.			

\* Water Temperature: Select the water temperature to the wash cycles.

Always follow garment manufacturer's care label or instructions when laundering.

\* Notes: Neutral detergent is recommended.

\* Set energy program at "Cotton" + "Cold" + "1000RPM" + "Intensive" option for test in accordance or in conformity with standards IEC 60456:2010 & BEE schedule - 12 (Revision - 3).

## \*\*Extra Options

Program	Turbo Wash	Intensive	Rinse+	Delay End	Pre Wash
Cotton	•	•	•	•	•
Cotton+ □	•	•	•	•	•
Mixed Fabric	•	•	•	•	•
Easy Care	•	•	•	•	•
Duvet	•	•	•	•	•
Allergy Care	•	•	•	•	•
Baby Steam Care	•	•	•	•	•
Sportswear	•	•	•	•	•
Hand/Wool	•	•	•	•	•
Delicates	•	•	•	•	•
TurboWash 59	•	•	•	•	•
Tub Clean	•	•	•	•	•
Speed 14	•	•	•	•	•

\*\* Extra Options selection can vary depending on different models.

## How to use washer

\*Part can be different according to different models.

### Control Panel

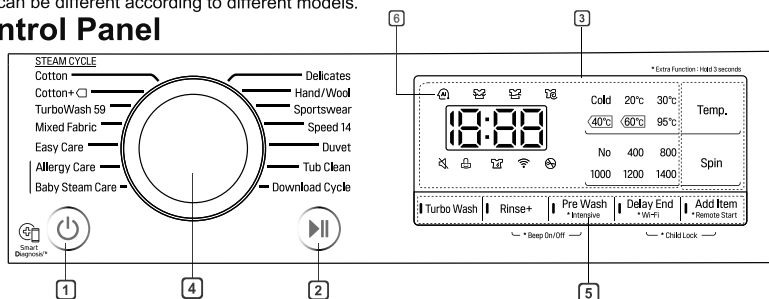

#### 1 Power Button

- Press the **Power** button to turn the washing machine on.

#### 2 Start/Pause Button

- This **Start/Pause** button is used to start the wash cycle or pause the wash cycle.
- If a temporary stop of the wash cycle is needed, press the **Start/Pause** button.



#### 3 Display

- The display shows the settings, estimated time remaining, options, and status messages. When the product is turned on, the default settings in the display will illuminate.
- The display shows estimate time remaining. While the size of the load is being calculated automatically, blinking  or 'Detecting' appears.
- The RPM may differ depending on the models.

#### 4 Program Knob

- Programs are available according to the laundry type.
- The lamp will light up to indicate the selected program.

#### 5 Options

- This allows you to select an additional program and will light when selected.
- Use these buttons to select the desired program options for the selected cycle.
- : When the heavily soiled laundry is washed intensively, this icon is illuminated.
- : This icon is illuminated when the appliance is connected to WLAN network.



#### Beep On / Off

1. Press the **Power** button.
2. Press the **Start/Pause** button.
3. Press and hold the **Rinse+** and **Pre Wash** button simultaneously for 3 seconds to set the Beep on/off function.

#### NOTE

- Once the Beep on/off function is set, the setting is memorized even after the power is turned off.
- If you want to turn the Beeper off, simply repeat this process.

#### 6 AI DD

- **AI DD**  provides the desired washing and spinning
-  is activated when **Cotton**, **Mixed Fabric** and **Easy Care** programs are selected and operated when these selected programs are in operation

# How to use washer

\*Part can be different according to different models.

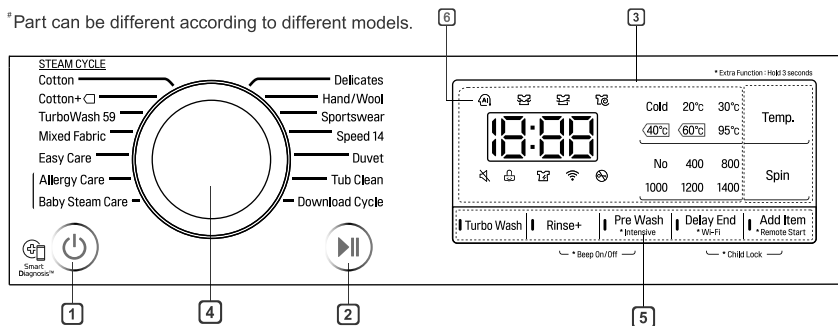

- (1) Button : Power                      (3) Display                      (5) Options  
 (2) Button : Start / Pause          (4) Dial : Program          (6) AI DD

## Power

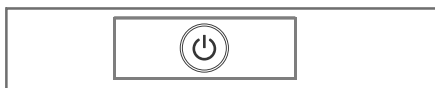

### 1. Power

- Press the Power button to turn the washing machine ON/OFF.
- To cancel the Time Delay function, the power button should be pressed.

### 2. Initial Program

- When the Power button is pressed, the washer is ready for Cotton program and the other initial conditions as follows.
- So, if you want to advance into the washing cycle without changing the program, just press the **Start/Pause** button and then the washer will proceed.

#### ■ Initial program

[FHV1409#WW/L/S/B/P,  
 FHV1408#WW/L/S/B/P],  
 Cotton Program/ Main Wash/ Normal  
 Rinse/1400rpm/40°C

## Program

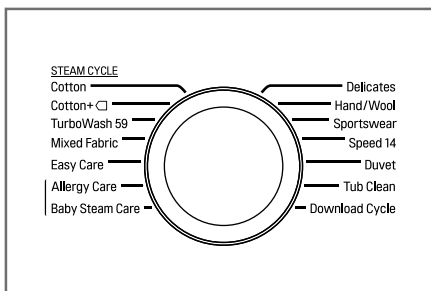

- 14 programs are available according to the laundry type.
- Lamp will light up to indicate selected program.
- When **Start/Pause** button is pressed, the Cotton program is automatically selected.
- By turning the Program dial, the program is selected in order of  
**"Cotton - Cotton+ - TurboWash 59 - Mixed Fabric - Easy Care - Allergy Care - Baby Steam Care - Download Cycle - Tub Clean - Duvet - Speed 14 - Sportswear - Hand/Wool - Delicates"**

*Regarding to the laundry type for each program Please refer to the page 14.*



# How to use washer

## Start/Pause



### 1. Start

- This **Start/Pause** button is used to start wash cycle or pause the wash cycle.

### 2. Pause

- If temporary stop of wash cycle is needed, press the **Start/Pause** button.
- When in Pause, the power is turned off automatically after 15 minutes approx.

## Door Lock (🔒)



- Lights whenever the door of the washer is locked.
- The door can be unlocked by pressing the **Start/Pause** button to stop the washer.
- The door can be opened after a short delay.

## Detecting (📶)

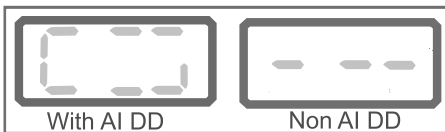

- While the "📶" or "📶" is shown in the display the machine rotates slowly and detects how much laundry is loaded in the drum. It will take a few seconds.

## Option



- By Pressing the Option Button, all Option functions may be selected.

## 1. Turbo Wash (1)

- Separate Jet of water is supplied from Gasket for better washing quality.

## 2. Intensive (👕)

- If the laundry is heavily soiled "Intensive" option is effective.
- By selecting the intensive option, the wash time may be extended, depending on the program selected.

## 3. Rinse+ (1)

- Additional Rinse for better washing quality.

## 4. Delay End (1)

- You can set a time delay so that the washing machine will start automatically and finish after a specified time interval.

## 5. Add Item (1)

Laundry can be added or removed after the washing program is started.

1. Press the **Add Item** button when the LED is turned on.
2. Add or remove laundry.
3. Close the door and Press the **Start/Pause** button.

### NOTE

- For safety reasons, the door remains locked when the water level or temperature is high. It is not possible to add laundry during this time.
- If the water temperature in the drum is high, wait until it cools down.

### ⚠ CAUTION

- When adding laundry, make sure to completely push it into the drum. If laundry gets stuck in the door latch hole, the rubber packing may be damaged, causing water leakage and malfunction.
- Forcing the door open may cause part damage, destruction, or safety problems.
- If you open the door while there are a lot of suds and water in the drum, the suds or water may flow, causing burn injury or wet floor.

*The required lamp will light up for identification.*

## Pre Wash (1)

- If the laundry is heavily soiled, the Pre Wash program is recommended (Press for about three seconds).

# How to use washer

## Child Lock (🔒)



If you choose to lock the buttons on the control assembly to prevent tampering this function may be selected.

- Child Lock can be set by pressing the **Delay End** and **Add Item** simultaneously. (About three seconds)

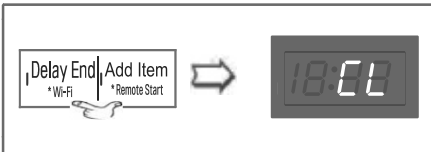

- To deactivate Child Lock system, press **Delay End** and **Add Item** simultaneously again. (About three seconds)

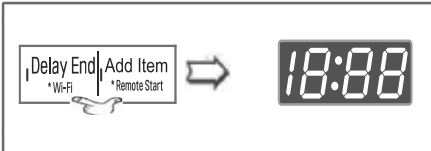

- To change to the desired program, whilst in child lock mode.

1. Press **Delay End** and **Add Item** once again. (About three seconds)
2. Press the **Start/Pause** button.
3. Select the desired program and press the **Start/Pause** button again.

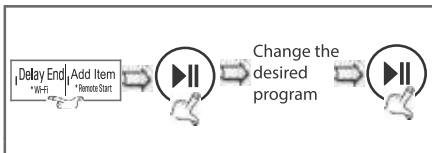

The child lock can be set at any time and it can be deactivated only by using child lock cancel process. Turning the power off and operational errors will not affect child lock.

## Tub Clean

### Tub Clean

Tub Clean course can be set by selecting **Tub Clean** program

When Tub Clean course is set, display “tcl” .



**TUB CLEAN** is special cycle to clean inside of the washer. This cycle uses higher water level with higher spin speed. Perform this cycle regularly.

#### How to use the Tub Clean cycle:

1. Remove any clothing or items from the washer and close the door.
2. Open the dispenser drawer and add Anti limescale powder to the main wash compartment.

**NOTE** : Do not add any detergent to the detergent compartments. Excessive suds may generate & leak from the washer.

3. Close the dispenser drawer slowly.
4. Power On and then select **Tub Clean** program. then “tcl” is displayed in LED.
5. Press the Start/Pause button to start.
6. After the cycle is complete, leave the door open so that moisture present inside the washer can dry.

#### ⚠ CAUTION

If there is a small child, be careful not to leave the door open for too long.

## Wi-Fi (📶)/Remote Start

- In order to use Wi-Fi/Remote Start. Please refer Smart Functions page.

# H ow to use washer

## Spin

No	400	800	<b>Spin</b>
1000	1200	1400	

FHV1409#WW/L/S/B/P  
FHV1408#WW/L/S/B/P

- After selecting the spin course, the spin speed can be chosen by pressing the spin button.

### 1. Spin selection

- Spin Speed is available according to the program as follows

[FHV1409#WW/L/S/B/P, FHV1408#WW/L/S/B/P]

- **Cotton, Cotton+** , **Download Cycle, Mixed Fabric, Allergy Care, Easy Care, Speed 14**  
No-400-800-1000-1200-1400
- **Duvet, Baby Steam Care**  
No-400-800-1000
- **Sportswear, Delicates, Hand/Wool**  
No-400-800
- **TurboWash 59**  
400-800-1000-1200-1400

### 2. No spin

- If No spin is selected, the washer stops after draining water.

*The required lamp will light up for identification.*

# H ow to use washer

## Water Temp.

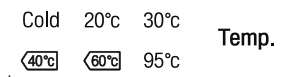

- By pressing the Temp. button, the water temperature can be selected.
- **Cold**
- **20°C / 30°C / 40°C / 60°C / 95°C**
- Water temperature can be selected according to the program.

**The required temperature lamp will light up for identification.**

**For the more detailed information, please refer to the page14.**

## Delay End



### **Preparing washing before starting "Delay End"**

- Turn on the water tap.
- Load laundry and close the door.
- Place the detergent and fabric softener in the drawer.

### • How to set " Delay End"

- Press **Power** button.
- Turn the **Program** dial to select the program you require.
- Press **Delay End** button and set the desired time.
- Press the **Start/Pause** button. (":" blinks.)
- If **Delay End** button is pressed, "3:00" is displayed. The maximum delayed time is 19 hours and the minimum time is 3 hours.
- Each pressing of the button advances on time delay by one hour.
- To cancel the **Delay End**, press the **Power** button.
- **Delay End** is 'expected time' from the present to the completion of washing cycle or selected process (Wash, Rinse, Spin).
- **According to the condition of water supply and temperature, the delayed time and the actual washing time may vary.**

## Display



### 1. Special function display

- When child lock is selected, the “**CL**” is displayed.
- When delay end is selected, it shows the remaining time to finish the selected program.

### 2. Self diagnosis display

- If the machine encounters a fault during operation, the associated fault will be displayed.
  - “**PE**” : Water pressure sensing error
  - “**FE**” : Problem of overfilling water
  - “**dE**” : Door is not closed
  - “**LE**” : Over load in motor
  - “**lE**” : Water inlet trouble
  - “**QE**” : Drainage trouble
  - “**UE**” : Unbalanced load
  - “**TE**” : Water temperature trouble
  - “**FF**” : Supply/Drain hose or drain pump frozen
  - “**RE**” : Water Leaks
  - “**dHE**” : Does not dry

*If these error letters are displayed, please refer to the troubleshooting page 31 and follow the guide.*

### 3. Completion of washing

- When washing cycle is completed, usually “**End**” is displayed on the “*Multi display*”.

### 4. Time left

- During washing cycle, the remaining washing time is displayed.
- The washing time may vary by the amount of laundry, water pressure, water temperature and other washing conditions.
- If an unbalanced load is detected or if the suds removing program operates, the wash time may be extended.

## Using LG ThinQ Application

LG ThinQ application allows you to communicate with the appliance using smartphone

### LG ThinQ application features

Communicate with the appliance from a smartphone using the convenient smart features.

### Washer cycle (Remote start, Download Cycle)

Set or download any preferred cycle and operate by remote control.

### Tub Clean Coach

This function shows how many cycles remain before running the Tub clean function

### Energy Monitoring

This function checks the energy consumption of the recently used cycles & monthly average.

### Smart Diagnosis

This function provides useful information for diagnosing and solving issues with the appliance based on the pattern of use.

### Settings

Allows you to set various options on the appliance and in the application

### Push Alert

When the cycle is complete or the appliance has problems, you have the option of receiving push notification on smartphone. The notification are triggered even if LG ThinQ application is off.

### NOTE

- If you change your wireless router, Internet service provider, or password, delete the registered appliance from the **LG ThinQ** application and register it again.
- The application is subject to change for appliance improvement purposes without notice to users.
- Functions may vary by model.

## Before Using LG ThinQ Application

- 1 Check the distance between the appliance and the wireless router (Wi-Fi network).
  - If the distance between the appliance and the wireless router is too far, the signal strength becomes weak. It may take a long time to register or installation may fail.
- 2 Turn off the **Mobile data** or **Cellular Data** on your smartphone.

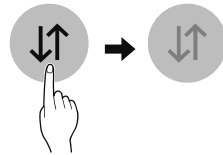

- 3 Connect your smartphone to the wireless router.

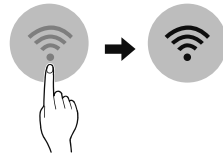

### NOTE

- To verify the Wi-Fi connection, check that **Wi-Fi**  icon on the control panel is lit.
- The appliance supports 2.4 GHz Wi-Fi networks only. To check your network frequency, contact your Internet service provider or refer to your wireless router manual.
- **LG ThinQ** is not responsible for any network connection problems or any faults, malfunctions, or errors caused by network connection.
- For reasons not attributable to LGE's negligence, the service may not operate due to external factors such as, but not limited to, Wi-Fi unavailability, Wi-Fi disconnection, local app store policy, or app unavailability.

## NOTE

- If the appliance is having trouble connecting to the Wi-Fi network, it may be too far from the router. Purchase a Wi-Fi repeater (range extender) to improve the Wi-Fi signal strength.
- The Wi-Fi connection may not connect or may be interrupted because of the home network environment.
- The network connection may not work properly depending on the Internet service provider.
- The surrounding wireless environment can make the wireless network service run slowly.
- The appliance cannot be registered due to problems with the wireless signal transmission. Unplug the appliance and wait about a minute before trying again.
- If the firewall on your wireless router is enabled, disable the firewall or add an exception to it.
- The wireless network name (SSID) should be a combination of English letters and numbers. (Do not use special characters.)
- Smartphone user interface (UI) may vary depending on the mobile operating system (OS) and the manufacturer.
- If the security protocol of the router is set to **WEP**, you may fail to set up the network. Please change it to other security protocols (**WPA2** is recommended) and register the product again.

## Installing the LG ThinQ Application

- Search for the **LG ThinQ** application from the Google Play Store or Apple App Store on a smartphone. Follow instructions to download and install the application.

## Using the Appliance Remotely

### Remote Start

Use a smartphone to control your appliance remotely. You can also monitor your cycle operation so you know how much time is left in the cycle.

### Using this Function

- 1 Press the **Power** button.
- 2 Put the laundry into the drum
- 3 Press and hold **Remote Start** button for 3 seconds to enable the remote control function
- 4 Start a cycle from the **LG ThinQ** application on your smartphone.

### NOTE

- Once the function is enabled, You can only start a cycle from the **LG ThinQ** smartphone application. If the cycle is not started, the appliance will wait to start the cycle until it is turned off remotely from the application or this function is disabled.
- If the door has been opened, you cannot start a cycle remotely

## Disable this function manually

When this function is activated, press and hold the **Remote start** button for 3 seconds.

## Download Cycle

You can download new and special cycles that are not included in the basic cycles on the appliance. Appliances that have been successfully registered can download a variety of speciality cycles specific to the appliance.

Once cycle download is completed in the appliance, the product keeps the downloaded cycle until a new is downloaded

## Open Source Software Notice Information

To obtain the source code under GPL, LGPL, MPL, and other open source licenses, that is contained in this product, please visit <http://opensource.lge.com>.

In addition to the source code, all referred license terms, warranty disclaimers and copyright notices are available for download.

LG Electronics will also provide open source code to you on CD-ROM for a charge covering the cost of performing such distribution (such as the cost of media, shipping, and handling) upon email request to [opensource@lge.com](mailto:opensource@lge.com).

This offer is valid for period of three years after our last shipment of this product. This offer is valid to anyone in the receipt of this information.



# Maintenance

\* Before cleaning the washer interior, unplug the electrical power cord to avoid electrical shock hazards.

\* When disposing of the appliance, cut off the mains cable, and destroy the plug. Disable the door lock to prevent young children being trapped inside.

## ■ The water inlet filter

- " *IE* " error message will blink on the control panel when water does not enter the detergent drawer.

- If water is very hard or contains traces of lime deposit, the water inlet filter may become clogged.

It is therefore a good idea to clean it from time to time.

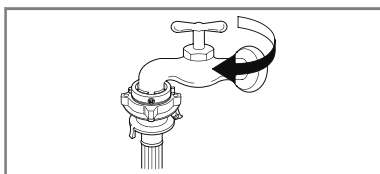

1. Turn off the water tap.

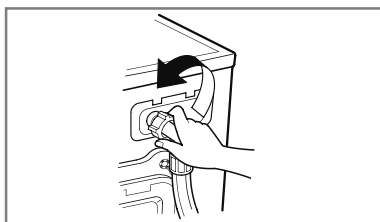

2. Unscrew the water inlet hose.

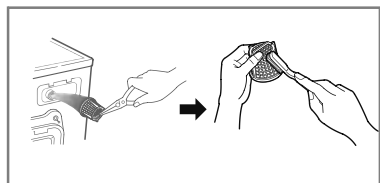

3. Clean the filter using a hard bristle brush.

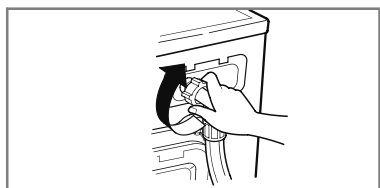

4. Tighten up the inlet hose.

## ■ The drain pump filter

\* The drain filter collects threads and small objects left in the laundry.

Check regularly that the filter is clean to ensure smooth running of your machine.

**⚠ CAUTION** First drain using the drain hose and then open the pump filter to remove whatever any threads or objects.

Be careful when draining if the water is hot.

\* Allow the water to cool down before cleaning the drain pump, carrying out emergency emptying or opening the door in an emergency.

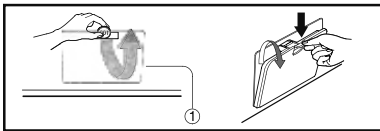

- 1.** Open the lower cover cap (①) by using a coin.  
Drain plug (②) to pull out the hose.

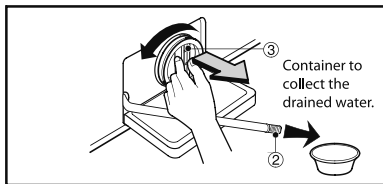

- 2.** Unplug the drain plug (②), allowing the water to flow out. At this time use a vessel to prevent water flowing on to the floor. When water does not flow any more, turn the pump filter (③) open to the left.

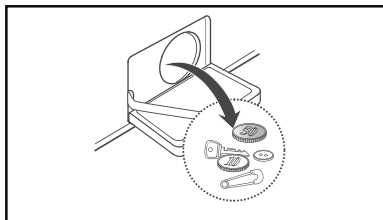

- 3.** Remove out any foreign material from the pump filter (③).

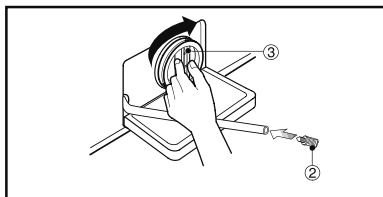

- 4.** After cleaning, turn the pump filter (③) clockwise and insert the drain plug (②) to the original place. Close the lower cover cap.

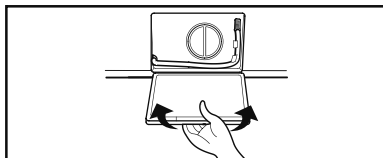

## ■ Dispenser drawer

- \* After a while detergents and fabric softeners leave a deposit in the drawer.
- It should be cleaned from time to time with a jet of running water.
- If necessary it can be removed completely from the machine by pressing the latch downwards and by pulling it out.
- To facilitate cleaning, the upper part of the fabric softener compartment can be removed.

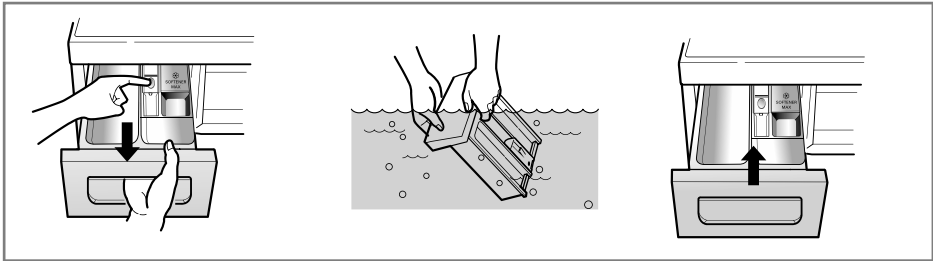

## ■ The drawer recess

- \* Detergent can also accumulate inside the recess which should be cleaned occasionally with an old toothbrush.
- Once you have finished cleaning, replace the drawer and run a rinse cycle without laundry.

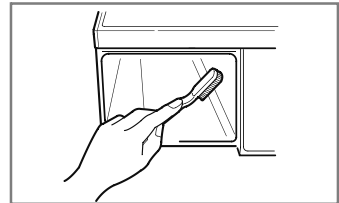

## ■ The washing drum

- If you live in a hard water area, limescale may continuously build up in places where it cannot be seen and thus not easily removed.  
Over time the build up of scale clogs appliances, and if it is not kept in check these may have to be replaced.
- Although the washing drum is made of Stainless steel, specks of rust can be caused by small metal articles (paper clips, safety pins) which have been left in the drum.
- The washing drum should be cleaned from time to time.
- If you use descaling agents, dyes or bleaches, make sure they are suitable for washing machine use.
- \* Descaler may contain chemicals that may damage part of your washing machine.
- \* Remove any spots with a stainless steel cleaning agent.
- \* Never use steel wool.

## ■ Cleaning your washer

### 1. Exterior

Proper care of your washer can extend its life.

The outside of the machine can be cleaned with warm water and a neutral non abrasive household detergent.

Immediately wipe off any spills. Wipe with damp cloth.

Try not to hit surface with sharp objects.

※ IMPORTANT: Do not use methyated spirits, diluents or similar products.

### 2. Interior

Dry around the washer door opening, flexible gasket and door glass.

Run washer through a complete cycle using hot water.

Repeat process if necessary.

#### NOTE

Remove hard water deposits using only cleaners labeled as washer safe.

## ■ Cold condition

If the washer is stored in an area where freezing may occur or moved in freezing temperatures, the washer may not operate normally,

Follow the below said instruction to prevent damage to the washer

1. Turn off water supply tap.
2. Disconnect hoses from water supply and drain water from hoses.
3. Plug electrical cord into a properly grounded electrical outlet.
4. Add 1gallon(3.8L) of nontoxic recreational vehicle(RV) antifreeze into an empty wash drum. Close the door.
5. Set spin cycle and let washer spin for 1minute to drain out all water.  
Not all of the RV antifreeze will be expelled.
6. Unplug electrical power cord, dry the drum interior, and close the door.
7. Remove dispenser drawer drain and dry excessive water from the compartments.
8. Store washer in an upright position.
9. To remove antifreeze from washer after storage, run empty washer through a complete cycle using detergent. Do not add wash load.































# Troubleshooting guide

\* This washing machine is equipped with automatic safety functions which detect and diagnose faults at an early stage and react appropriately  
 When the machine does not function properly or does not function at all, check the following points before you contact your service provider.

Symptom	Possible Cause	Solution
Rattling and clanking noise	<ul style="list-style-type: none"> <li>Foreign objects such as coins or safety pins maybe in drum or pump.</li> </ul>	<p>Stop washer and check drum and drain filter.</p> <p>If noise continues after washer is restarted, call your authorised service centre.</p>
Thumping sound	<ul style="list-style-type: none"> <li>Heavy wash loads may produce a thumping sound. This is usually normal.</li> </ul>	<p>If sound continues, washer is probably out of balance. Stop and redistribute wash load.</p>
Vibrating noise	<ul style="list-style-type: none"> <li>Have all the transit bolts and packing been removed?</li> <li>Are all the feet resting firmly on the ground?</li> </ul>	<p>If not removed during installation. Refer to Installation guide for removing transit bolts.</p> <p>Wash load may be unevenly distributed in drum. Stop washer and rearrange wash load.</p>
Water leaks	<ul style="list-style-type: none"> <li>Fill hoses or drain hose are loose at tap or washer.</li> <li>House drain pipes are clogged.</li> </ul>	<p>Check and tighten hose connections.</p> <p>Unclog drain pipe. Contact plumber if necessary.</p>
Oversudsing		<p>Too much detergent or unsuitable detergent may cause excessive foaming which may result in water leaks.</p>
Water does not enter washer or it enters slowly	<ul style="list-style-type: none"> <li>Water supply is not adequate in area.</li> <li>Water supply tap is not completely open.</li> <li>Water inlet hose(s) are kinked.</li> <li>The filter of the inlet hose(s) clogged.</li> </ul>	<p>Check another tap in the house.</p> <p>Fully open tap.</p> <p>Straighten hose.</p> <p>Check the filter of the inlet hose.</p>
Water in the washer does not drain or drains slowly	<ul style="list-style-type: none"> <li>Drain hose is kinked or clogged.</li> <li>The drain filter is clogged.</li> </ul>	<p>Clean and straighten the drain hose.</p> <p>Clean the drain filter</p>



Symptom	Possible Cause	Solution
Washer does not start	<ul style="list-style-type: none"> <li>• Electrical power cord may not be plugged in or connection may be loose.</li> <li>• House fuse blown, circuit breaker tripped, or a power outage has occurred.</li> <li>• Water supply tap is not turned on.</li> </ul>	<p>Makesure plug fits tightly in wall outlet.</p> <p>Reset circuit breaker or replace fuse. Do not increase fuse capacity. If problem is a circuit overload, have it corrected by a qualified electrician. Turn on water supply tap.</p>
Washer will not spin	<ul style="list-style-type: none"> <li>• Check that the door is firmly shut.</li> </ul>	<p>Close the door and press the Start/Pause button. After pressing the Start/Pause button, it may take a few moments before the clothes washer begins to spin. The door must lock before spin can be achieved.</p> <p>Add 1 or 2 similar items to help balance the load. Rearrange load to allow proper spinning</p>
Door does not open		<p>Once machine has started, the door can not be opened for safety reasons. Check if the "Door Lock" icon is illuminated. You can safely open the door after the "Door Lock" icon turns off.</p>
Wash cycle time delayed		<p>The washing time may vary by the amount of laundry, water pressure, water temperature and other usage conditions. If the imbalance is detected or if the suds removing program works, the wash time shall be increased.</p>
Fabric softner overflow	<ul style="list-style-type: none"> <li>• Too much softener may cause an overflow.</li> </ul>	<p>Follow softener guidelines to ensure appropriate amount is used. Do not exceed the maximum fill line.</p>
Softeners dispensed too early		<p>Close the dispenser drawer slowly. Do not open the drawer during the wash cycle.</p>
Dry problem	<p>Check water supply tap.</p>	<ul style="list-style-type: none"> <li>• Do not overload. Check that the washing machine is draining properly to extract adequate water from the load. Clothes load is too small to tumble properly. Add a few towels.</li> <li>• Turn off water supply tap.</li> </ul>

# Troubleshooting guide

Symptoms	Reason	Solution
 	Water supply is not adequate in area.	• Check another tap in the house.
	Water supply taps are not completely open.	• Fully open tap.
	Water supply hose(s) are kinked.	• Straighten hose(s).
	The filter of the supply hose(s) are clogged.	• Check the filter of the supply hose.
 	Load is too small.	• Add 1 or 2 similar items to help balance the load.
	Load is out of balance.	• Add 1 or 2 similar items to help balance the load.
	The appliance has an imbalance detection and correction system. If individual heavy articles are loaded (e.g. bath mat, bath robe, etc.) this system may stop spinning or even interrupt the spin cycle altogether.	• Rearrange load to allow proper spinning.
	If the laundry is still too wet at the end of the cycle, add smaller articles of laundry to balance the load and repeat the spin cycle.	• Rearrange load to allow proper spinning.
 	Drain hose is kinked or clogged.	• Clean and straighten the drain hose.
	The drain filter is clogged.	• Clean the drain filter.
   	Ensure door is not open.	• Close the door completely. If <i>dE</i> , <i>dE 1</i> , <i>dE 2</i> is not released, call for service.
  	Control error.	• Unplug the power plug and call for service.
  	Water overfills due to the faulty water valve.	• Close the water tap. • Unplug the power plug. • Call for service.
  	Malfunction of water level sensor.	• Close the water tap. • Unplug the power plug. • Call for service.
  	Over load in motor.	• Allow the washing machine to stand for 30 minutes to allow the motor to cool, then restart the cycle.
  	Is supply/drain hose or drain pump frozen?	• Supply warm water into the drum and unfreeze drain hose and drain pump. Wet a towel in warm water and apply to supply hose.
  	Water leaks.	• Call for service.
 	Does not dry	• Call for service.

# Troubleshooting guide

## Smart Diagnosis™ Using a Smart Phone

- For appliances with the  or  logo  
Use this function if you need an accurate diagnosis by an LG Electronics customer information centre when the appliance malfunctions or fails.

Smart Diagnosis™ can not be activated unless the appliance is connected to power. If the appliance is unable to turn on, then troubleshooting must be done without using Smart Diagnosis™.

## Using Smart Diagnosis™

### Smart Diagnosis™ Through the Customer Information Centre

Use this function if you need an accurate diagnosis by an LG Electronics customer information centre when the appliance malfunctions or fails. Use this function only to contact the service representative, not during normal operation.

- 1 Press the **Power** button to turn on the washing machine. Do not press any other buttons or turn the programme selector knob.
- 2 When instructed to do so by the call centre, place the mouthpiece of your phone close to the **Power** button.

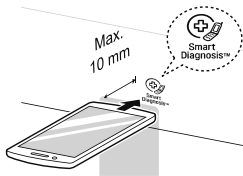

- 3 Press and hold the **Temp.** button for three seconds, while holding the phone mouthpiece to the icon or **Power** button.

- 4 Keep the phone in place until the tone transmission has finished. Time remaining for data transfer is displayed.
  - For best results, do not move the phone while the tones are being transmitted.
  - If the call centre agent is not able to get an accurate recording of the data, you may be asked to try again.
- 5 Once the countdown is over and the tones have stopped, resume your conversation with the call centre agent, who will then be able to assist you using the information transmitted for analysis.

### NOTE

- The Smart Diagnosis™ function depends on the local call quality.
- The communication performance will improve and you can receive better service if you use the home phone.
- If the Smart Diagnosis™ data transfer is poor due to poor call quality, you may not receive the best Smart Diagnosis™ service.



# Terms of Warranty

## What Is Not Covered:

- Service trips to your home to teach you how to use the product.
  - If the product is connected to any voltage other than that shown on the rating plate.
  - If the fault is caused by accident, neglect, misuse or Act of God.
  - If the fault is caused by factors other than normal domestic use or use in accordance with the owner's manual.
  - Provide instruction on use of product or change the set-up of the product.
  - If the fault is caused by pests for example, rats or cockroaches etc..
  - Noise or vibration that is considered normal for example water drain sound, spin sound, or warming beeps.
  - Correcting the installation for example, levelling the product, adjustment of drain.
  - Normal maintenance which recommended by the owner's manual.
  - Removal of foreign objects / substances from the machine, including the pump and inlet hose filter for example, grit, nails, bra wires, buttons etc.
  - Replace fuses in or correct house wiring or correct house plumbing.
  - Correction of unauthorized repairs.
  - Incidental or consequential damage to personal property caused by possible defects with this appliance.
  - If this product is used for commercial purpose, it is not warranted.
- (Example : Public places such as public bathroom, lodging house, training center, dormitory)
- If the product is installed outside the normal service area, any cost of transportation involved in the repair of the product, or the replacement of a defective part, shall be borne by the owner.

## Disposal of your old appliance (as per e-waste Rules)



1. When this crossed out wheeled bin symbol is depicted on the product and its operator's manual, it means the product is covered by the e-waste Management and Handling Rules, 2011 and are meant to be recycled, dismantled, refurbished or disposed off.
2. **Do's :**
  - a. The product is required to be handed over only to the authorized recycler for disposal.
  - b. Keep the product in isolated area, after it becomes non-functional/un-repairable so as to prevent its accidental breakage.

### Don't :

- a. The product should not be opened by the user himself/herself, but only by authorized service personnel.
  - b. The product is not meant for re-sale to any unauthorized agencies/scrap dealer/kabariwalah.
  - c. The product is not meant for mixing into household waste stream.
  - d. Do not keep any replaced spare part(s) from the product in exposed area.
3. Any disposal through unauthorized agencies/person will attract action under Environment (Protection) Act 1986.
  4. "This product is complied with the requirement of Hazardous Substances as specified under Rule 13 (1) & (2) of the E-Waste (Management & Handling) Rules, 2011".
  5. To locate a nearest collection centre or call for pick-up (limited area only) for disposal of this appliance, please contact Toll Free No. **1800-315-9999 / 1800-180-9999** for details. All collection centre and pick up facilities are done by third parties with **LG Electronics India Pvt. Ltd.** Merely as a facilitator.

For more detailed information, please visit : <http://www.lg.com/in> 📞 **9711709999** (LG WhatsApp No.)

## अपने पुराने उपकरण का निपटान (ई-अपशिष्ट नियम के अनुसार)



1. जब इस काटे गये पहिये वाले बिन का चिह्न किसी उपकरण और इसके ऑपरेटर की पुस्तिका के साथ संलग्न होता है तो इसका मतलब है कि इसे ई-अपशिष्ट (प्रबंधन और हथालन) नियम 2011 के अन्तर्गत सम्मिलित किया गया है। और इसे नवीनीकरण, विघटन और निपटान के लिए बनाया गया है।
2. **करें :**
  - क- उपकरण को सिर्फ अधिकृत पुनः नवीनीकरणकर्ता को ही निपटारण करने हेतु हस्तान्तरित करें।
  - ख- जब उपकरण कार्यालय न हो इसके अलग क्षेत्र में रखें ताकि उपकरण से होने वाली दुर्घटनाओं से बचा जा सके।

### ना करें :

- क- इस उपकरण को स्वयं/खुद नहीं खोलना चाहिए, उपकरण को केवल अधिकृत अधिकारी के द्वारा ही खोला जाना चाहिए।
  - ख- इस उपकरण को पुनः बिक्री के लिए किसी भी कबाड़ीवाला / भंगार वाला / अनाधिकृत संस्था को न दें।
  - ग- इस उपकरण को किसी घरेलू अपशिष्ट सामान के साथ मिलाकर न रखें।
  - घ- उपकरण के बदले हुए या आंतरिक पूर्णों को खुले क्षेत्र में न रखें।
3. यदि किसी अनाधिकृत विभाग या व्यक्ति के द्वारा निपटारण किया जाता है तो यह पर्यावरण (सुरक्षा) धारा 1986 के अन्तर्गत आता है।
  4. यह उत्पाद ई-अपशिष्ट (प्रबंधन और हथालन) नियम 2011 के अन्तर्गत 13(1) एवं (2) के तहत निर्दिष्ट खतरनाक पदार्थों की आवश्यकता का पालन करता है।
  5. उपरोक्त पदार्थों के निपटारण के लिए नजदीकी निपटारण संस्थान (संकीर्ण क्षेत्र) में कॉल करें। अधिक जानकारी के लिए हमारे टोल फ्री नम्बर **1800-315-9999 / 1800-180-9999** पर कॉल करें। सभी संग्रहण केन्द्र व पिक-अप की सुविधाएँ किसी थर्ड-पार्टी जो **LG Electronics India Pvt. Ltd.** को अपनी सेवाएँ प्रदान कर रही हों, से करवाएँ।
- अधिक जानकारी के लिए देखें वेबसाइट : <http://www.lg.com/in> 📞 **9711709999** (LG WhatsApp No.)

# Memo

# Memo



MFL71716230

**LG 24 x 7 CUSTOMER CARE**

**1800-315-9999**  
(Toll Free)

**1800-180-9999**  
(Send SMS)

**5757554**  
(Send SMS)

[www.lg.com/in/support](http://www.lg.com/in/support)

LG WhatsApp No.  
**9711709999**

LG Service India Mobile App  
Available at Google Play

[www.facebook.com/lgindiapage/](https://www.facebook.com/lgindiapage/)

[www.twitter.com/LGIndia](https://www.twitter.com/LGIndia)

To know more about LG,  
visit [www.lg.com/in](http://www.lg.com/in)  
For Corporate/Institutional enquiries,  
please write to [corp.enquiries@lge.com](mailto:corp.enquiries@lge.com)