



# Washing Machine

---

User manual

WA7\*T4\*\*\*\*/WA6\*T4\*\*\*\*

---

**SAMSUNG**

# Contents

---

<b>Safety information</b>	<b>3</b>
What you need to know about the safety instructions	3
Important safety symbols	3
Important safety precautions	4
Instructions about the WEEE	9
<b>Installation</b>	<b>10</b>
What's included	10
Installation requirements	11
Step-by-step installation	12
<b>Before you start</b>	<b>19</b>
The basics	19
Smart Check	21
Laundry guidelines	22
<b>Operations</b>	<b>26</b>
Control panel	26
Simple steps to start	27
Auto cycles	28
Manual cycles	29
Special features	30
<b>Maintenance</b>	<b>31</b>
Cleaning	31
<b>Troubleshooting</b>	<b>36</b>
Checkpoints	36
Information codes	40
<b>Specifications</b>	<b>41</b>
Specification sheet	41
<b>Terms of Warranty</b>	<b>43</b>
Warranty not applicable in any of the following cases	43

# Safety information

---

Congratulations on your new Samsung washing machine. This manual contains important information on the installation, use and care of your appliance. Please take some time to read this manual to take full advantage of your washing machine's many benefits and features.

## What you need to know about the safety instructions

---

Please read this manual thoroughly to ensure that you know how to safely and efficiently operate the extensive features and functions of your new appliance. Please store the manual in a safe location close to the appliance for future reference. Use this appliance only for its intended purpose as described in this instruction manual.

Warnings and Important Safety Instructions in this manual do not cover all possible conditions and situations that may occur. It is your responsibility to use common sense, caution and care when installing, maintaining and operating your washing machine. Because the following operating instructions cover various models, the characteristics of your washing machine may differ slightly from those described in this manual and not all warning signs may be applicable. If you have any questions or concerns, contact your nearest service centre or find help and information online at [www.samsung.com](http://www.samsung.com).

## Important safety symbols

---

What the icons and signs in this user manual mean:

### **WARNING**

Hazards or unsafe practices that may result in **severe personal injury, death and/or property damage**.

### **CAUTION**

Hazards or unsafe practices that may result in **personal injury and/or property damage**.

### **NOTE**

Indicates that a risk of personal injury or material damage exists.

These warning signs are here to prevent injury to yourself and others. Please follow them explicitly.

After reading this manual, store it in a safe place for future reference.

Read all instructions before using the appliance.

As with any equipment that uses electricity and moving parts, potential hazards exist. To safely operate this appliance, familiarize yourself with its operation and exercise care when using it.

# Safety information

---

## Important safety precautions

---

### **WARNING**

To reduce the risk of fire, electric shock, or injury to persons when using your appliance, follow basic precautions, including the following:

1. This appliance is not intended for use by persons (including children) with reduced physical, sensory or mental capabilities, or lack of experience and knowledge, unless they have been given supervision or instruction concerning use of the appliance by a person responsible for their safety.
2. **For use in Europe:** This appliance can be used by children aged from 8 years and above and persons with reduced physical, sensory or mental capabilities or lack of experience and knowledge if they have been given supervision or instruction concerning use of the appliance in a safe way and understand the hazards involved. Children shall not play with the appliance. Cleaning and user maintenance shall not be made by children without supervision.
3. Children should be supervised to ensure that they do not play with the appliance.
4. If the supply cord is damaged, it must be replaced by the manufacturer, its service agent or similarly qualified persons in order to avoid a hazard.
5. The new hose-sets supplied with the appliance are to be used and that old hose-sets should not be reused.
6. For washing machines having ventilation openings in the base, the installation instructions shall state that the openings must not be obstructed by a carpet.
7. **For use in Europe:** Children of less than 3 years should be kept away unless continuously supervised.

- 
- 8. CAUTION:** In order to avoid a hazard due to inadvertent resetting of the thermal cut-out, this appliance must not be supplied through an external switching device, such as a timer, or connected to a circuit that is regularly switched on and off by the utility.
- 9. CAUTION:** Do not use the water to exceed 50 °C when using the hot water in your washing machine.  
Plastic parts may be deformed or damaged, and this may result in electric shock or fire.
- 10.** This appliance is intended to be used in household only and it is not intended to be used such as:
- staff kitchen areas in shops, offices and other working environments;
  - farm houses;
  - by clients in hotels, motels and other residential type environments;
  - bed and breakfast type environments;
  - areas for communal use in blocks of flats or in launderettes.

## Critical installation warnings

---

### **WARNING**

The installation of this appliance must be performed by a qualified technician or service company.

- Failure to do so may result in electric shock, fire, an explosion, problems with the product, or injury.

Plug the power cord into a wall socket that meets local electrical specifications. Use the socket for this appliance only, and do not use an extension cord.

- Sharing a wall socket with other appliances using a power strip or extending the power cord may result in electric shock or fire.
- Ensure that the power voltage, frequency, and current are the same as those of the product specifications. Failure to do so may result in electric shock or fire. Plug the power plug into the wall socket firmly.

# Safety information

---

Remove all foreign substances such as dust or water from the power plug terminals and contact points using a dry cloth on a regular basis.

- Unplug the power plug and clean it with a dry cloth.
- Failure to do so may result in electric shock or fire.
- Plug the power plug into the wall socket so that the cord is running towards the floor. If you plug the power plug into the socket in the opposite direction, the electric wires within the cable may be damaged and this may result in electric shock or fire.

This appliance must be properly grounded.

Do not ground the appliance to a gas pipe, plastic water pipe, or telephone line.

- This may result in electric shock, fire, an explosion, or problems with the product.
- Never plug the power cord into a socket that is not grounded correctly and make sure that it is in accordance with local and national regulations.

Do not install this appliance near a heater or any inflammable material.

Do not install this appliance in a humid, oily or dusty location, or in a location exposed to direct sunlight or water (rain drops).

Do not install this appliance in a location exposed to low temperatures.

- Frost may cause the tubes to burst.

Do not use an electric transformer.

- This may result in electric shock or fire.

Do not use a damaged power plug, damaged power cord, or loose wall socket.

- This may result in electric shock or fire.

Do not pull or excessively bend the power cord.

Do not twist or tie the power cord.

Do not hook the power cord over a metal object, place a heavy object on the power cord, insert the power cord between objects, or push the power cord into the space behind the appliance.

- This may result in electric shock or fire.

This appliance should be positioned so that the power plug, the water supply taps, and the drain pipes are accessible.

## Installation cautions

---

### CAUTION

This appliance should be positioned in such a way that the power plug is easily accessible.

- Failure to do so may result in electric shock or fire due to electric leakage.

---

## Critical usage warnings

---

### WARNING

If the appliance is flooded, turn off the water & power supplies immediately and contact your nearest service centre.

- Do not touch the power plug with wet hands.
- Failure to do so may result in electric shock.

If the appliance generates a strange noise, a burning smell, or smoke, unplug the power plug immediately and contact your nearest Samsung Customer Service.

- Failure to do so may result in electric shock or fire.

In the event of a gas leak (such as propane gas, LP gas, etc.), ventilate immediately without touching the power plug. Do not touch the appliance or power cord.

- Do not use a ventilating fan.
- A spark may result in an explosion or fire.

Do not let children play in or on the washing machine. In addition, when disposing of the appliance, remove the lid.

- If trapped inside the product, children may suffocate to death.

Do not wash items contaminated with gasoline, kerosene, benzene, paint thinner, alcohol or other inflammable or explosive substances.

- This may result in electric shock, fire, or an explosion.

Do not touch the power plug with wet hands.

- This may result in electric shock.

Do not insert your hand or a metal object under the washing machine while an operation is in progress.

- This may result in injury.

Do not attempt to repair, disassemble, or modify the appliance yourself.

- Do not use a fuse (such as copper, steel wire, etc.) other than a standard fuse.
- When the appliance needs to be repaired or reinstalled, contact your nearest service centre.
- Failure to do so may result in electric shock, fire, problems with the product, or injury.
- In this case, the product will not be covered by the standard warranty provided by Samsung and no responsibility can be attributed to Samsung for malfunctions or damages resulting from doing it.

Unplug the power plug when the appliance is not being used for long periods of time or during a thunder or lightning storm.

- Failure to do so may result in electric shock or fire.

# Safety information

---

Do not put your hand into the spinning tub during the spin cycle.

- This may result in injury. If the tub does not stop spinning within 15 seconds after you open the lid, contact your nearest Samsung Customer Service.

Do not let children (or pets) play in or on your washing machine.

The washing machine door does not open easily from the inside and children may be seriously injured if trapped inside.

## Usage cautions

---

### CAUTION

When the washing machine is contaminated by a foreign substance such as detergent, dirt, food waste, etc., unplug the power plug and clean the washing machine using a damp, soft cloth.

- Failure to do so may result in discolouration, deformation, damage, or rust.

The product you have purchased is designed for domestic use only.

Using the product for business purposes qualifies as a product misuse. In this case, the product will not be covered by the standard warranty provided by Samsung and no responsibility can be attributed to Samsung for malfunctions or damages resulting from such misuse.

Do not stand on the appliance or place objects (such as laundry, lighted candles, lighted cigarettes, dishes, chemicals, metal objects, etc.) on the appliance.

- This may result in electric shock, fire, problems with the product, or injury.

Do not press the buttons using sharp objects such as pins, knives, fingernails, etc.

- This may result in electric shock or injury.

## Critical cleaning warnings

---

### WARNING

Do not clean the appliance by spraying water directly onto it.

Do not use the a strong acidic cleaning agent.

Before cleaning or performing maintenance, unplug the appliance from the wall socket.

- Failure to do so may result in electric shock or fire.



---

## Instructions about the WEEE

---



### **Correct Disposal of This Product (Waste Electrical & Electronic Equipment)**

(Applicable in countries with separate collection systems)

This marking on the product, accessories or literature indicates that the product and its electronic accessories (e.g. charger, headset, USB cable) should not be disposed of with other household waste at the end of their working life. To prevent possible harm to the environment or human health from uncontrolled waste disposal, please separate these items from other types of waste and recycle them responsibly to promote the sustainable reuse of material resources.

Household users should contact either the retailer where they purchased this product, or their local government office, for details of where and how they can take these items for environmentally safe recycling.

Business users should contact their supplier and check the terms and conditions of the purchase contract. This product and its electronic accessories should not be mixed with other commercial wastes for disposal.

For more information on safe disposal and recycling, visit our website [www.samsung.com](http://www.samsung.com) or contact our Helpline numbers on the last page.

# Installation

Follow these instructions carefully to ensure proper installation of the washing machine and to prevent accidents when doing laundry.

## What's included

Make sure all the parts are included in the product package. If you have missing or defective parts, contact a local Samsung customer centre or the retailer.

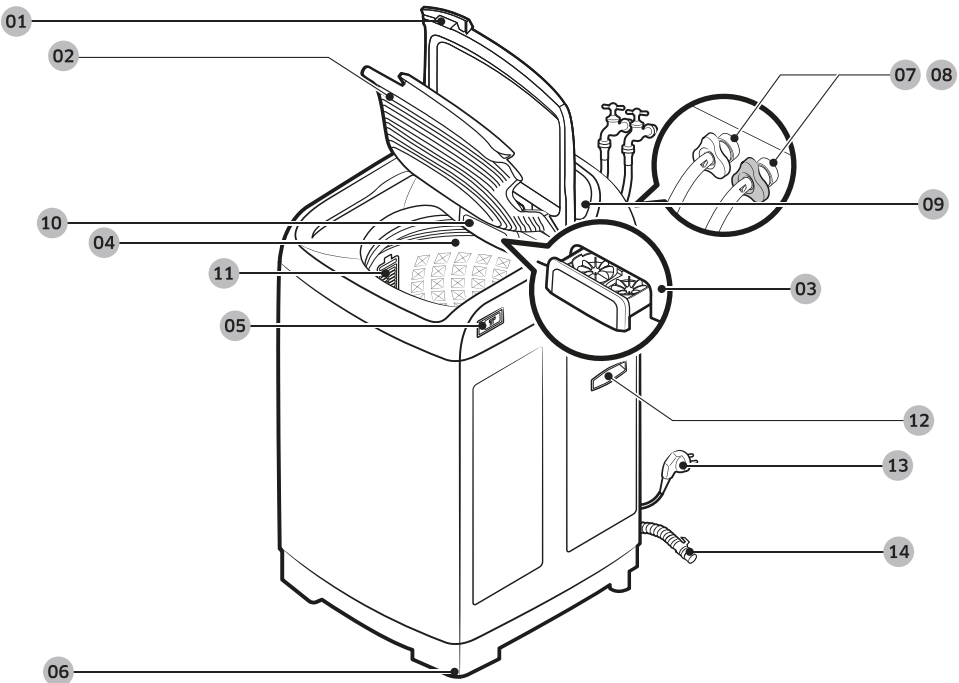

- |                             |                              |                               |
|-----------------------------|------------------------------|-------------------------------|
| <b>01</b> Door              | <b>02</b> Built-in sink *    | <b>03</b> Wing distributor *  |
| <b>04</b> Tub               | <b>05</b> Water Jet *        | <b>06</b> Levelling feet      |
| <b>07</b> Water hose (Cold) | <b>08</b> Water hose (Hot) * | <b>09</b> Control panel       |
| <b>10</b> Detergent box     | <b>11</b> Lint filter        | <b>12</b> Handle (for moving) |
| <b>13</b> Power cord        | <b>14</b> Drain hose         |                               |

---

**NOTE**

- Availability of parts with an asterisk (\*) depends on the model.
- Door: Make sure to keep the door closed while the washing machine is operating.
- Lint filter: This collects lint that builds up from the laundry being washed.
- Levelling feet: Adjust the feet to level the washing machine on a flat floor.

## Installation requirements

---

### Electrical supply and grounding

#### WARNING

- AC 220-240 V / 50 Hz fuse or circuit breaker is required.
- Use an individual branch circuit specific to the washing machine.
- Do NOT use an extension cord.
- Use only the power cord that comes with the washing machine.
- Do NOT connect the ground wire to plastic plumbing, gas lines, or hot water pipes.

### Levelling

- To prevent tumbling or noise, install the washing machine on a solid, flat floor without a platform or bricks.
- Keep the washing machine at 10 cm from each adjacent wall.

### Water supply

- Make sure water taps are easily accessible.
- Turn off the taps when the washing machine is not in use.
- Check for any leaks at the water hose fittings on a regular basis.

### Drain

- Make sure the drain hose is not clogged.
- We recommend a standpipe in height of 90-100 cm. The drain hose must be connected through the hose clip to the standpipe, and the standpipe must fully cover the drain hose.  
The standpipe specifications mentioned here are only applicable to pump-type models.

# Installation

## Step-by-step installation

### STEP 1 Select a location

Location requirements:

- Solid, level surface without carpeting or flooring that may obstruct ventilation
- Away from direct sunlight
- Adequate room for ventilation and wiring
- The ambient temperature is always higher than the freezing point (0 °C)
- Away from a heat source

### Assembling the rat protection panel (applicable models only)

Tilt the washing machine a little, insert the shutter and finally fix the shutter with screw to the base as shown in the picture.

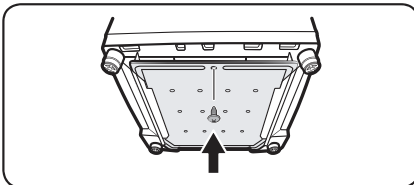
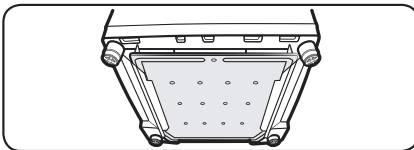
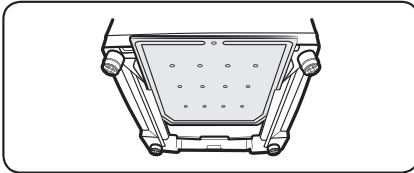
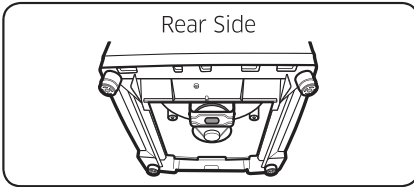

1. Insert the rat protection panel to the assembling hole on back side to the end.

2. If you have difficulty inserting the panel lift up the washing machine a little and insert it.

## STEP 2 Adjust the levelling feet

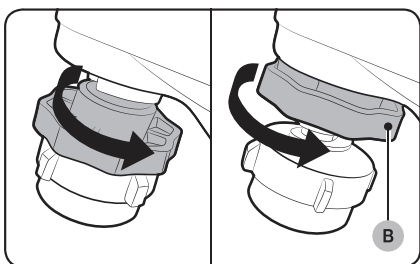
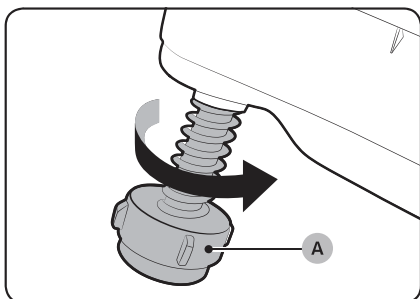

Unpack the product package.

1. Gently slide the washing machine into position. Excessive force may damage the levelling feet (A).
2. Level the washing machine by manually adjusting the levelling feet.
3. When levelling is complete, tighten the nuts (B) if provided (some models may not have the nuts).

### WARNING

Packaging materials can be dangerous to children. Dispose all packaging material (plastic bags, polystyrene, etc.) out of children's reach.

## STEP 3 Connect the water hose

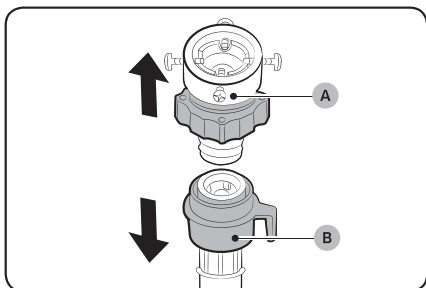

Connect the water hose to the water tap.

1. Remove the adaptor (A) from the water hose (B).

# Installation

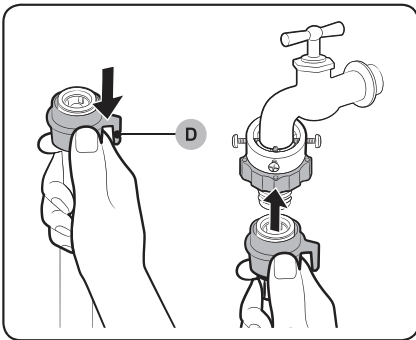
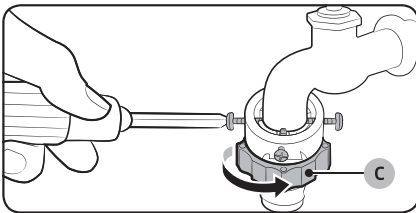
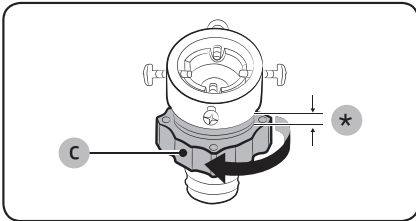
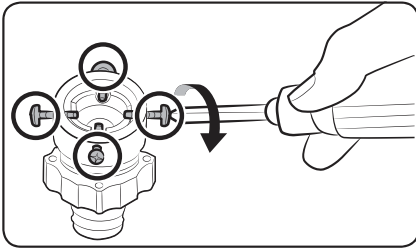

2. Use a Phillips screwdriver to loosen four screws on the adaptor.
3. Hold the adaptor and turn **part (C)** in the arrow direction to loosen it by 5 mm (\*).
4. Insert the adaptor into the water tap, and tighten the screws while lifting up the adaptor.
5. Turn **part (C)** in the arrow direction to tighten it.
6. While holding down **part (D)**, connect the water hose to the adaptor. Then, release **part (D)**. The hose fits into the adaptor with a clicking sound.

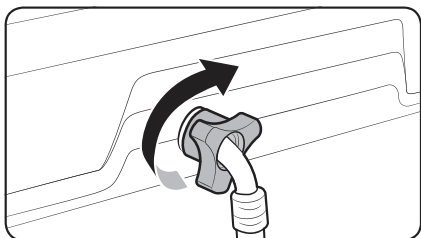

7. Connect the other end of the water hose to the inlet valve on the back of the washing machine. Turn the hose clockwise to tighten.

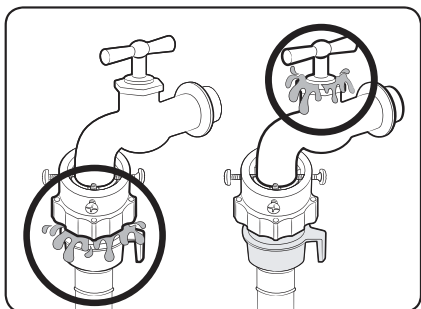

8. Open the water tap and check if there are any leaks around the connection areas.
  - If there are water leaks, repeat the steps above.

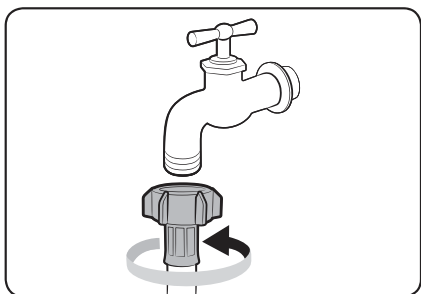

- If using a screw type of water tap, connect the water hose to the water tap as shown.

 **WARNING**

Stop using the washing machine if there is a water leak, and contact a local Samsung service centre. Otherwise, this may cause electric shock.

 **CAUTION**

Do not stretch the water hose by force. If the hose is too short, replace the hose with a longer, high-pressure hose.

# Installation

---

## NOTE

- After connecting the water hose to the adaptor, check if it is connected properly by pulling the water hose downwards.
- Use a standard type of water tap. If the tap is square-shaped or too big, remove the spacer ring before inserting the tap into the adaptor.

## STEP 4 Position the drain hose

---

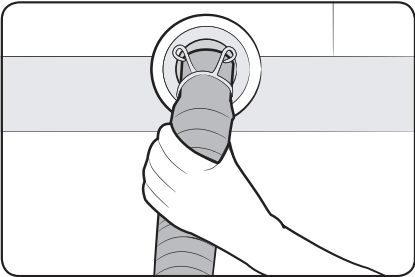
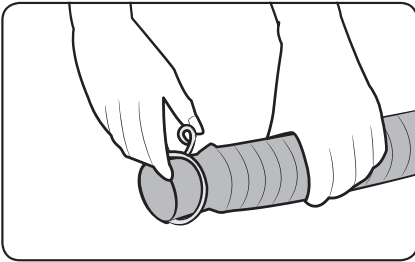

### General type

1. Press and hold down the joint ring, and insert it into the drain hose.
2. Insert the drain hose into the drain outlet. Make sure to connect them firmly using the joint ring. The drain hose is extensible. Adjust the length of the drain hose as needed.



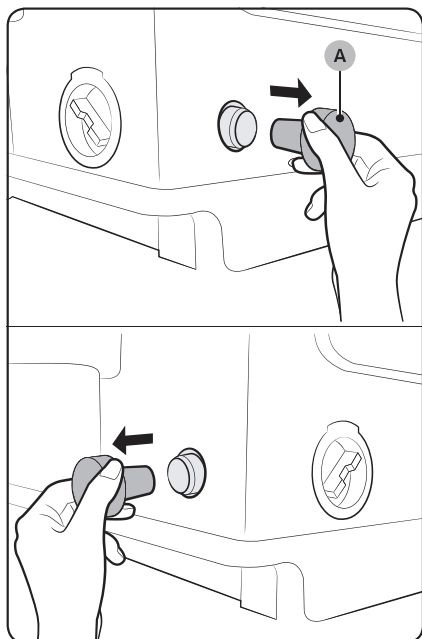

### Pump type

1. Open the hose cap (A), and insert the drain hose. Tighten the drain hose using the joint ring.

#### NOTE

- The position (side or rear) of the drain outlet depends on the model.
- Availability of the hose cap depends on the model.

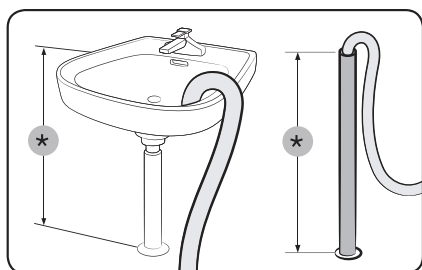

2. Connect the other end of the drain hose to a standpipe or basin that is positioned 90-100 cm (\*) from the floor.

#### WARNING

Make sure the end of the drain hose is not submerged by water. Otherwise, the washing machine may suffer serious damage.

# Installation

## ⚠ CAUTION

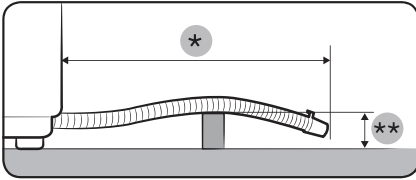

- Do not exceed **3 m (\*)** for the total length of extended hoses.
- Do not let the drain hose run over doorsills that protrude **5 cm (\*\*)** or more from the floor.
- Do not run the drain hose under the bottom of the machine.

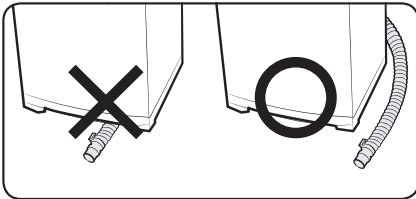

## STEP 5 Power on

Plug the power cord into a wall socket featuring an AC 220-240 V / 50 Hz approved electrical outlet protected by a fuse or circuit breaker. Then, press **POWER** to turn on the washing machine.

# Before you start

## The basics

### Prewash (Water Jet & Built-in sink)

#### CAUTION

- Do not abuse Water Jet. Excessive use of Water Jet increases water consumption.
- When running water to the tub, do that gently. Otherwise, water may overflow the tub.

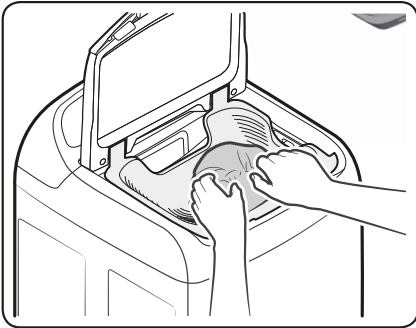
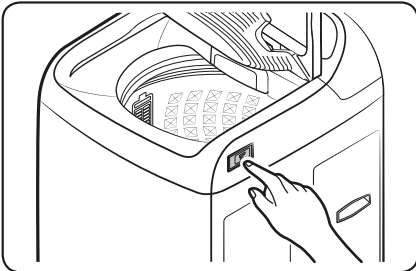

Water Jet and Built-in sink help you hand-wash before the washing machine starts operation. Water Jet is available only when the door is open with the water level set to less than High. For prewashing, use the Built-in sink that is designed to facilitate the hand-wash.

1. With the door open, lower the Built-in sink, and put clothes to prewash on it.
2. Press the **Water Jet** button to supply water to the Built-in sink, and hand-wash.
3. When done, you can either reuse the water in the main cycle or simply drain.
  - To reuse the water, run the water down to the tub manually.
  - To drain the water, press **Drain**.

#### NOTE

- If you want to hand-wash while the machine is operating, press **START/PAUSE** to stop operation, and then follow steps 1-3 above.
- If you open both the door and the Built-in sink, lower the Built-in sink manually for prewashing.
- For the first-time use, Water Jet supplies water to the detergent box for 1 second to extract air from the water hose. After the first use, Water Jet stops automatically after 5 minutes of water supply.
- Do not use for other than prewashing, such as washing shoes or animals.

# Before you start

## Detergent Box

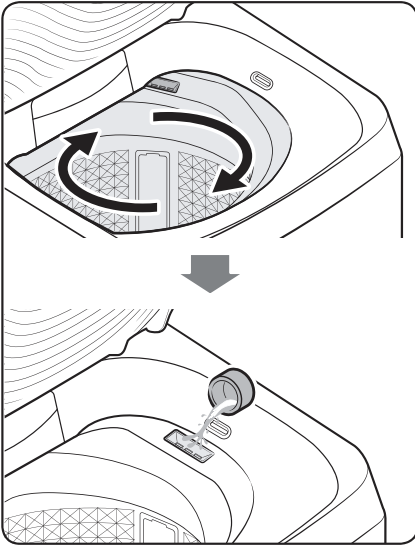
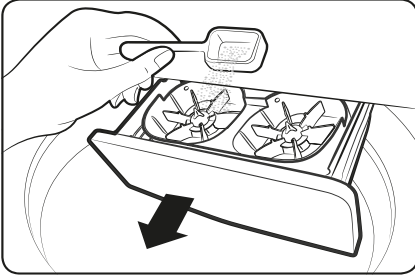

To add a laundry-specific detergent, follow these steps:

1. Open the door then the Built-in sink to reveal the tub.
2. Open the detergent box by pulling in the direction of the arrow as shown in the figure and then put the detergent in the detergent box.
3. Put in one-time amount of detergent evenly so the detergent may not brim over the box.
4. Add fabric softener as recommended by the manufacturer, and then close the cover.

### NOTE

If you cannot see the fabric softener compartment, manually rotate the drum clockwise to reveal it.

### CAUTION

Make sure to use detergent as appropriate. An excessive amount of detergent may not dissolve well.

- Do not add too much softener. This may reduce the performance.
- Do not leave softener into the softener dispenser for a long time. The softener becomes hardened and may not dissolve well.

---

## Smart Check

---

To enable this function, you must first download the **Samsung Washer** app at the **Play Store** or the **Apple Store**, and install it on a mobile device featuring a camera function.

The Smart Check function has been optimized for Galaxy & iPhone series (applicable models only).

1. Press **POWER** to turn on the washing machine.
2. Press and hold **Rinse Times + Spin Time** simultaneously for 3 seconds to enter the Smart Check mode.
3. The washing machine starts the self-diagnosis procedure and displays an information code if a problem is detected.
4. Run the **Samsung Washer** app on your mobile device, and tap **Smart Check**.
5. Put the mobile device close to the washing machine's display so that the mobile device and the washing machine face each other. Then, the information code will be recognized automatically by the app.
6. When the information code is recognized correctly, the app provides detailed information about the problem with applicable solutions.

### NOTE

- The function name, Smart Check, may differ depending on the language.
- If there is strong reflected light on the washing machine display, the app may fail to recognize the information code.
- If the app fails to recognize the Smart Check code consecutively, enter the information code manually onto the app screen.

# Before you start

---

## Laundry guidelines

---

### Checkpoints

---

- Check for stains or dirt. Apply a little detergent to a white towel. Rub the white towel and the dirty clothes together to transfer the dirt or colour to the white towel.
- Before washing, pre-treat the sleeves, collars, dress hems, and pockets by brushing with detergent.
- Wrinkle-processed clothes made of wool must be specially treated by tightening them with threads before washing. Remove the threads after washing and drying is complete.



### CAUTION

- Do not keep heavy clothes or objects in the tub.
  - Do not put candles or a heat source in or on the washing machine.
  - Do not wash these clothes:
    - Neckties, brassieres, jackets, suits, and coats can be easily deformed by shrinking or discolouring on the surface. These clothes are mostly made of rayon, polynosic, cuff, and/or blended fabric.
    - Wrinkle-processed, embossed, or resin processed clothes easily deform merely by soaking in water.
    - Clothes that are easily discoloured made from cotton, wool, wrinkled silk, leather wear and accessories, and leather ornamented clothes and accessories.
    - Waterproof sheets, mattresses, or specific items (\*)
    - Thick and hard mattresses, even if they are marked Washable on the care label. Mattresses may cause vibrations, resulting in physical injury, or damage to the machine, wall, or floor as well as the laundry itself.
- \* Wool quilts, rain covers, fishing jackets and trousers, skiwear, sleeping bags, diaper covers, sweat suits, vehicle covers for automobiles, bicycles, and motorcycles, bath rugs, and other waterproof items.

---

## STEP 1 Sort

---

**Sort the laundry according to these criteria:**

- Care Label: Sort the laundry into cottons, mixed fibres, synthetics, silks, wools, and rayon.
- Colour: Separate whites from colours.
- Size: Mixing different-sized items together in the tub improves the washing performance.
- Sensitivity: Follow the cloth-specific instructions on the care label of delicate items such as pure, new woollen items, curtains, and silk items.

### NOTE

Make sure to check the care label on the clothing, and sort them accordingly before starting the wash.

## STEP 2 Empty pockets

---

**Empty all the pockets of your laundry items, and remove dirt and/or soils from them.**

- Metal objects such as coins, pins, and buckles on clothing may damage other laundry items as well as the tub.
- Turn clothing with buttons and embroideries inside out.
- If pants or jacket zippers are open while washing, the tub may be damaged.
- Zippers should be closed and fixed with a string.
- Clothing with long strings may become entangled with other clothes. Make sure to tie the strings before washing.

## STEP 3 Use a laundry net

---

- Brassieres (water washable) must be placed in a laundry net. Metal parts of the brassieres may break through and tear other laundry items.
- Cashmilon, large volume garments, and lightweight clothes (lace-decorated clothes, lingerie, nylon stocking, and synthetic fabrics) may float on water during washing and cause problems to the machine. Use the laundry net or wash them separately.
- Do not wash the laundry net by itself without other laundry. This may cause abnormal vibrations that could move the washing machine and result in injury.

### CAUTION

For inflatable items such as blankets, microfibre quilts, and waterproof materials, use the laundry net to fully soak the laundry in water.

- Inflatable items may cause damage to the laundry or the machine during the wash or drying process.
- Regardless of the size, blankets or quilts are safer and cleaner to wash one item at a time. Two different-sized blankets in the same load may compromise the drying performance due to unbalanced loads.

# Before you start

## To input a blanket

Fold the blanket into the **blanket-specific net (A)** as shown, and then insert the net in the tub below the **plastic area (B)** of the tub.

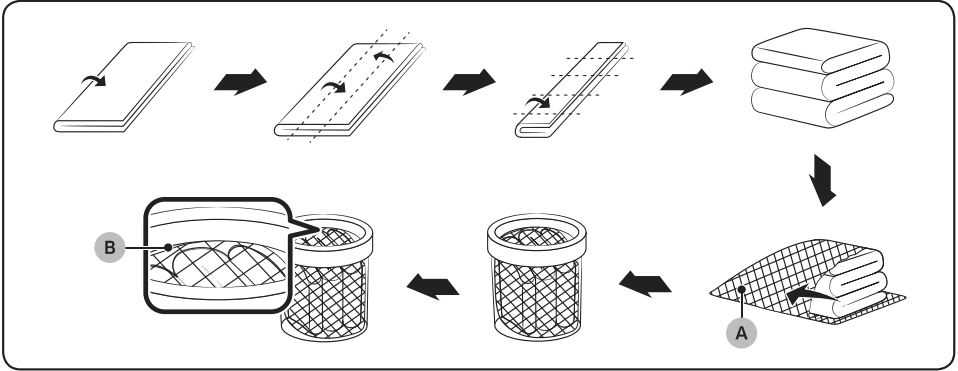

## STEP 4 Prewash (if necessary)

- To remove stains and dirt on collars, sleeves, hems, and pockets, apply detergent lightly and brush off.
- Use powder or liquid detergents. Do not use soap, as this may remain on the tub after washing.
- Prewash white socks, sleeves, and collars with a little detergent and a brush.

### CAUTION

Make sure the laundry is inserted completely.

- Any exposed part of the laundry may cause damage to the machine or the laundry itself, or a water leak.
- Do not overload the tub. Make sure no part of the laundry is exposed outside of the tub.

## STEP 5 Determine the load capacity

Do not overload the washing machine. Overloading may cause the washing machine to not wash properly.

### NOTE

When washing bedding or bedding covers, the wash time may be lengthened or the spin efficiency may be reduced. For bedding or bedding covers, the recommended load capacity is 3.0 kg or less.



---

**⚠ CAUTION**

If the laundry is unbalanced and the “Ub” information code is displayed, redistribute the load. Unbalanced laundry may reduce the spinning performance.

**STEP 6 Apply a proper detergent type**

---

The type of detergent depends on the type of fabric (cotton, synthetic, delicate items, wool), colour, wash temperature, and degree of soiling. Always use “low suds” laundry detergent, which is designed for automatic washing machines.

**⚠ CAUTION**

- Use an appropriate amount of detergent. Excess amounts of detergent do not produce much improvement in washing results but cause damage to the laundry due to deteriorated rinsing performance.
- Bleach is strong alkali in nature, causing damage to or discolouration of the laundry.
- Use a longer or added rinse cycle when using powder detergent that is very likely to remain on the laundry and cause bad odours after washing is complete.
- If an excessive amount of detergent is used especially in cold water, the detergent doesn't dissolve well, ending up with contaminated laundry, hoses, and/or tub.
- In case of timed washing, do not apply detergent directly to laundry or the tub. The laundry may be discoloured. Use the detergent box.
- When washing wool using the Delicate cycle, use only a neutral detergent to avoid discolouring the laundry.

**📖 NOTE**

- Follow the detergent manufacturer's recommendations based on the weight of the laundry, the degree of soiling, and the hardness of the water in your local area. If you are not sure about the water hardness, contact a local water authority.
- Do not use detergent that tends to be hardened or solidified. This detergent may remain after the rinse process, blocking the drain outlet.

# Operations

## Control panel

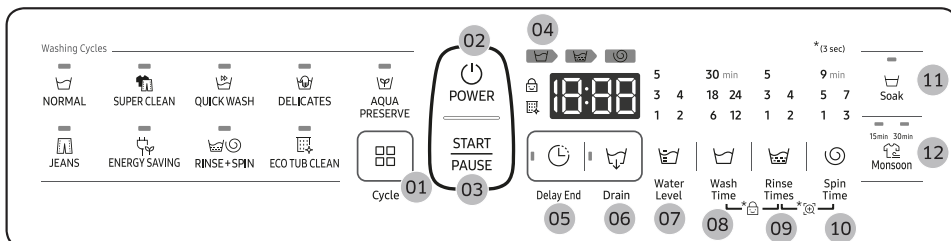
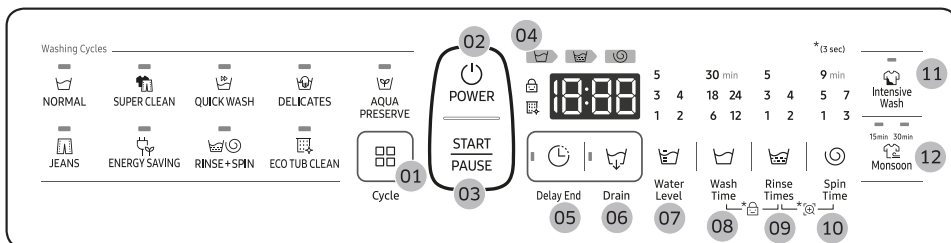

<b>01</b> Cycle	Press to select a desired cycle. The selected cycle's indicator will light up.
<b>02</b> POWER	Power on or off the washing machine.
<b>03</b> START/PAUSE	Select a cycle and press <b>START/PAUSE</b> to start the cycle. To stop the current operation, press <b>START/PAUSE</b> .
<b>04</b> Display	Displays the current cycle information and estimated time remaining, or an information code if the washing machine needs to be checked.
<b>05</b> Delay End	Delay the end of any cycle for up to 24 hours in one-hour increments. The displayed hour indicates the time the cycle will end.
<b>06</b> Drain	When draining is complete, the washing machine turns off automatically. <ul style="list-style-type: none"> <li>The <b>Drain</b> button is enabled only in Standby state.</li> <li>When draining is in process, the <b>START/PAUSE</b> button will be disabled.</li> </ul>
<b>07</b> Water Level	The water level is adjusted according to the cycle. However, you can change the level manually.
<b>08</b> Wash Time	Press to run a wash-only cycle, or to select a washing time between 6 minutes and 30 minutes. To run a wash-only cycle, press and hold this button for 3 seconds.
<b>09</b> Rinse Times	Press to run a rinse-only, or change the rinse count up to 5. To run a rinse-only cycle, press and hold this button for 3 seconds.
<b>10</b> Spin Time	Press to run a spin-only cycle, or to select a desired spin time. To run a spin-only cycle, press and hold this button for 3 seconds.

<b>11</b> Intensive Wash	Press this button when the laundry is heavily soiled and needs to be washed intensively. The cycle time will be increased if Intensive Wash is on.
Soak	With this selected, the washing machine adds a soaking process in advance of the main cycle.
<b>12</b> Monsoon	Use this option to speed up the drying process. Press the button to cycle through the times: 15 min > 30 min. <b>NOTE</b> <ul style="list-style-type: none"> <li>• This option is available only when a spinning cycle is selected.</li> <li>• This option is not available with the DELICATES, AQUA PRESERVE, or ECO TUB CLEAN cycle.</li> </ul>

## Simple steps to start

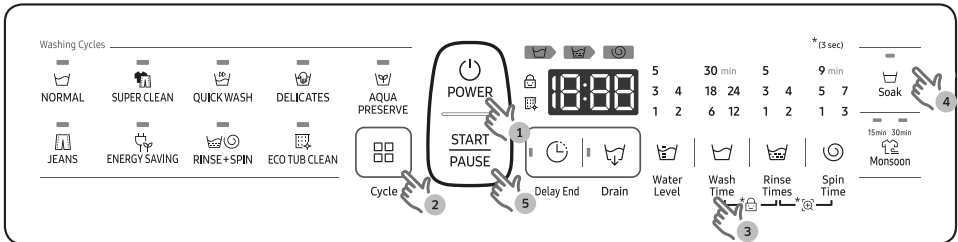
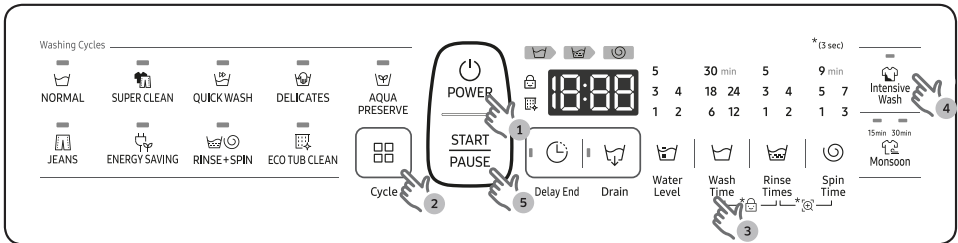

1. Press **POWER** to turn on the washing machine.
2. Press **Cycle** to select the desired cycle.
3. Change the cycle settings (**Water Level**, **Wash Time**, **Rinse Times**, and/or **Spin Time**) as necessary.
4. To add an option such as **Intensive Wash**, **Soak**, and **Monsoon**, press the correcting button.
5. Press **START/PAUSE**.

### To change the cycle during operation

1. Press **START/PAUSE** to stop operation.
2. Select a different cycle, and repeat steps 2-4 above if necessary.
3. Press **START/PAUSE** again to start the new cycle.

# Operations

## Auto cycles

Cycle	Description
NORMAL	For most fabrics including cottons, linens, and normally soiled items.
SUPER CLEAN	Select this if you want to produce powerful cleaning performance.
QUICK WASH	Select this for less soiled clothes, such as towels, in reduced time.
DELICATES	Select this for delicate items such as sweaters, cardigans, or wool clothes.
JEANS	Suitable for clothes that require a thorough wash.
ENERGY SAVING	Use this course to save energy.
RINSE+SPIN	For loads that need rinsing only or to add rinse-aided fabric softener to.
ECO TUB CLEAN	<ul style="list-style-type: none"><li>• Select this to clean the tub. The powerful spinning force removes impurities and bad odours from inside the tub.</li><li>• A blinking  indicator reminds you that it is time to clean the tub using Eco Tub Clean. For details, see the Cleaning section in this manual.</li></ul>
AQUA PRESERVE	Use this if you want to save the water to use. The water used in the rinse process will be reused for the next process.

## Manual cycles

You might want to use a single cycle to wash less soiled clothes. For example, you can run the wash cycle once for nightwear.

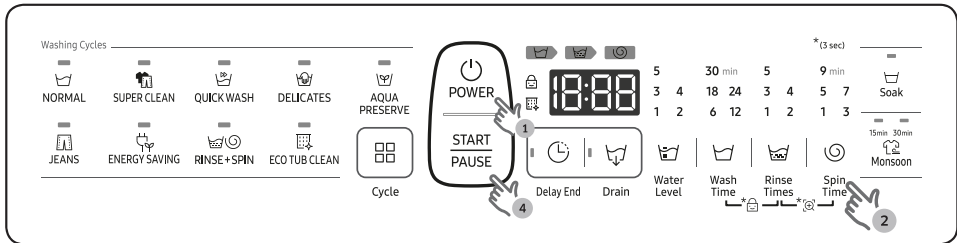
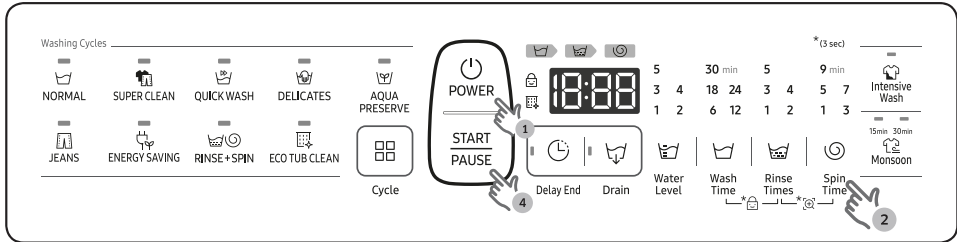

1. Press **POWER** to turn on the washing machine.
2. Press **Wash Time**, **Rinse Times**, **Spin Time** to run the individual cycle to your needs. The duration or count of each cycle can be adjusted by pressing the applicable button as many times as needed.

Wash Time	Rinse Times	Spin Time
6-30 minutes	1-5 times	1, 3, 5, 7, 9 minutes

3. If you want to run a combination of cycles, press applicable cycle buttons as below:

Wash + Rinse	Rinse + Spin	Wash + Rinse + Spin
Rinsing after washing	Spinning after rinsing	Washing, rinsing, and then spinning in sequence

4. Press **START/PAUSE**.

# Operations

## Special features

### Child Lock

Child Lock is designed to prevent accidents by children or infants, such as drowning in the tub.

#### To activate the Child Lock

Press and hold **Wash Time** and **Rinse Times** simultaneously for 3 seconds. The  indicator blinks.

#### To deactivate the Child Lock

Press and hold **Wash Time** and **Rinse Times** simultaneously for 3 seconds. The  indicator turns off. If the tub has contained water, simply restart the machine and press and hold **Wash Time** and **Rinse Times** simultaneously for 3 seconds to deactivate the Child Lock.

#### With the Child Lock enabled

- You can still manipulate on the control panel while the door is closed. If you open the door, an information code (**CL**, **dC**) appears with an alarm. Then, the machine starts forced draining after 30 seconds in order to prevent accidents.
- If the door is left open for 30 seconds with the tub containing water, the machine drains the water with the “**CL**” code, which you cannot stop.
- To add detergent or more laundry in the tub, or to change the cycle settings, you must first deactivate the Child Lock.

### Delay End

You can set the washing machine to finish a cycle later. The hour displayed indicates the time the wash will finish.

1. Select a cycle. Then, change the cycle settings if necessary.
2. Press **Delay End** repeatedly until a desired end time is set.
3. Press **START/PAUSE**. The lamp indicator next to the **Delay End** button turns on, and the timer starts.
4. To cancel **Delay End**, restart the washing machine by pressing **POWER**.

Real-life case

You want to finish a two-hour cycle 3 hours from now. To do this, add the Delay End option to the current cycle with a 3-hour setting, and then press **START/PAUSE** at 2:00 p.m. The washing machine starts operating at 3:00 p.m. and ends at 5:00 p.m. Provided below is the timeline for this example.



# Maintenance

---

## Cleaning

---

Keep the washing machine clean to prevent deteriorated performance and to preserve its life cycle.

### Exterior

- Clean the control panel with a soft, damp cloth. Do not use abrasive powders or cleaning pads. Do not spray cleaners directly on the panels.

### Eco Tub Clean

Regularly run this cycle to clean the tub and to remove bacteria from it.

1. Makes sure the tub is completely empty.
2. Press **POWER** to turn on the washing machine.
3. Press **Cycle** to select **ECO TUB CLEAN**. You can also use **Delay End** with Eco Tub Clean.
4. Press **START/PAUSE**.

### CAUTION

Only run Eco Tub Clean when the tub is completely empty. This may cause damage to the laundry or a problem with the washing machine.

### ECO TUB CLEAN reminder

- The  indicator reminds you of cleaning the tub when necessary. If you happen to see the indicator blinking after washing is complete, remove the laundry and run the ECO TUB CLEAN cycle.
- You can ignore this reminder and continue to run cycles normally because this is not a system failure. However, the reminder remains active for 6 consecutive cycles immediately after each cycle is complete.
- The reminder is activated once every 1-3 months, depending on the cycle count.
- To keep the tub clean, it is recommended to run ECO TUB CLEAN on a regular basis.

### Built-in sink

1. Open the door, and use a cloth or sponge to clean the Built-in sink.
2. Press the **Water Jet** button to supply water to the board. Use this water to rinse the board.

# Maintenance

## Cleaning the lint filter

Clean the filter net often to keep the washing machine clean.

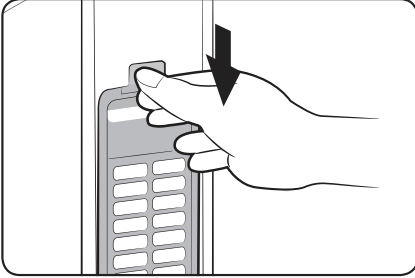

1. Push the upper part of the filter and pull in.

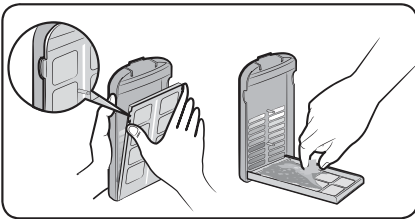

2. Open the cover as shown in the figure.
3. Then remove the lint from the filter.

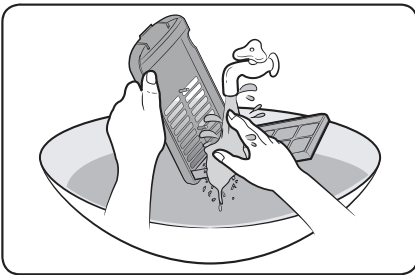

4. Clean the filter.



5. Close the cover and insert the lower part of the filter in the basket first and then push the filter with “click” sound.



### Pump filter (applicable models only)

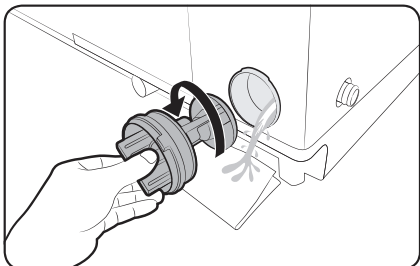

1. Put a floor-cloth or towel under the Pump filter. Turn the filter knob anticlockwise to remove.

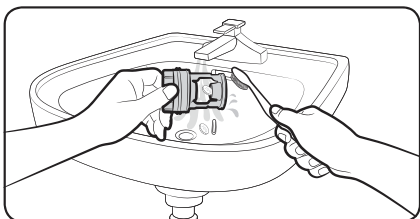

2. Clean the filter with running water and a soft brush.

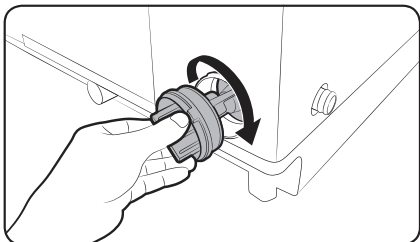

3. Reinsert the filter, and turn clockwise until it locks into position.

### Mesh filter

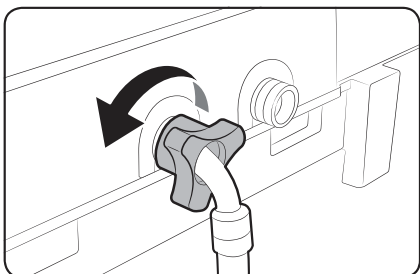

1. Turn the water hose counterclockwise to disconnect.

# Maintenance

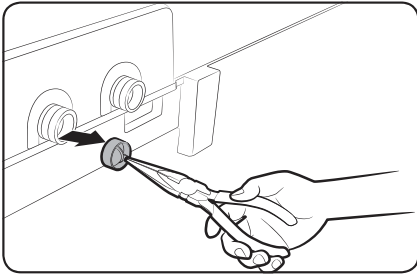

2. Use pliers to pull out the mesh filter from inside the water inlet as shown.

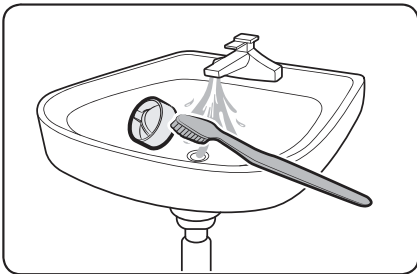

3. Use a soft brush to clean the filter with running water.

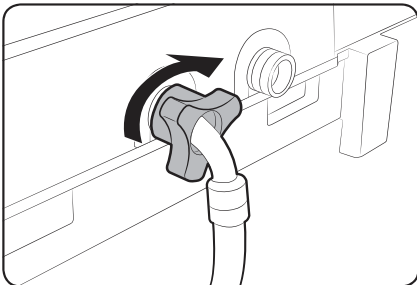

4. Reinsert the filter. Make sure it is tightened against water leaks.

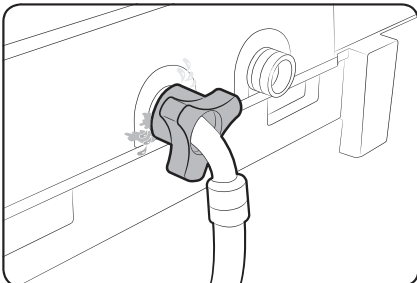

## Detergent Box

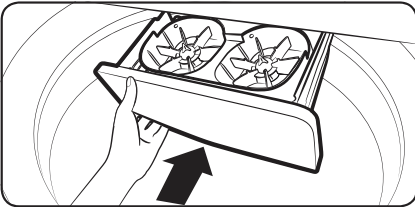
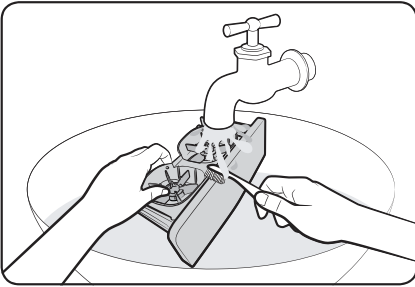
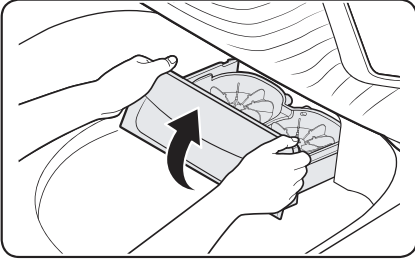

1. Open the door and then the Built-in sink to reveal the detergent box.
2. Pull out the detergent box, and then lift up with both hand to remove.
3. Clean the detergent box as well as the wing distributors with running water and a soft brush.
4. When complete, reinsert the wing distributors. Then, reinsert the detergent box to the washing machine.

# Troubleshooting

## Checkpoints

If you encounter an issue to check with the washing machine, first check the table below and try the suggestions.

Symptom	Action
Does not turn on.	<ul style="list-style-type: none"> <li>• Make sure you use rated power for the product.</li> <li>• Make sure the power cord is completely plugged in.</li> <li>• Check the fuse or reset the circuit breaker.</li> </ul>
Does not start.	<ul style="list-style-type: none"> <li>• Make sure the door is closed.</li> <li>• Make sure the water taps are open.</li> <li>• Make sure to press or tap <b>START/PAUSE</b> to start the washing machine.</li> <li>• Make sure Child Lock is not activated.</li> <li>• Before the washing machine starts to fill, it will make a series of clicking noises to check the door lock and does a quick drain.</li> <li>• Was the door opened during the spinning cycle? Close the door, and press or tap <b>START/PAUSE</b> to resume.</li> <li>• The machine enters Standby or is in a soaking cycle. Please wait.</li> <li>• Check the fuse or reset the circuit breaker.</li> </ul>
Water is not supplied.	<ul style="list-style-type: none"> <li>• Make sure you press or tap <b>START/PAUSE</b> after selecting the water supply.</li> <li>• Make sure the water taps are open.</li> <li>• Is the filter net at the water supply hose connector clogged? Clean the filter net by brushing with a toothbrush.</li> <li>• Is the water supply cut off? If the water supply is cut off, close the tap and power off.</li> <li>• Straighten the water supply hoses.</li> <li>• Open and close the door, then press or tap <b>START/PAUSE</b>.</li> <li>• If the water pressure is low, it takes longer to start washing.</li> <li>• If the water level is not as high as necessary or lower than expected, use the level selector to adjust the water level.</li> </ul>
After a cycle, detergent remains in the automatic dispenser.	<ul style="list-style-type: none"> <li>• Make sure the washing machine is running with sufficient water pressure.</li> <li>• Make sure the detergent box is properly inserted.</li> <li>• Remove and clean the detergent box, and then try again.</li> </ul>

Symptom	Action
Vibrates excessively or makes noise.	<ul style="list-style-type: none"> <li>• Make sure the washing machine is set on a level floor. If the floor is not level, use the levelling feet to adjust the washing machine.</li> <li>• Make sure the washing machine is not contacting any other object.</li> <li>• Make sure the laundry load is balanced.</li> <li>• Make sure the laundry is spread evenly in the washing machine. Spread out the laundry evenly and start again.</li> <li>• Make sure the space around the washing machine is free of objects.</li> <li>• Humming is produced normally during operation.</li> <li>• Objects such as coins can cause noise. Remove these objects from the washing machine after washing is complete.</li> </ul>
Stops.	<ul style="list-style-type: none"> <li>• Plug the power cord into a live electrical outlet.</li> <li>• Check the fuse or reset the circuit breaker.</li> <li>• Close the door, and press or tap <b>START/PAUSE</b> to start the washing machine. For your safety, the washing machine will not spin unless the door is closed.</li> <li>• Before the washing machine starts to fill, it will make a series of clicking noises to check the door lock and does a quick drain.</li> <li>• There may be a pause or soak period in the cycle. Wait briefly and the washing machine may start.</li> <li>• Make sure the inlet hose screens at the taps are not clogged. Periodically clean the screens.</li> <li>• This symptom occurs temporarily due to low voltages, and will be solved when power recovers.</li> </ul>
The ECO TUB CLEAN alarm does not turn off.	<ul style="list-style-type: none"> <li>• When the machine is diagnosed to be cleaned, the  indicator blinks for an hour. This recurs 6 consecutive times until you run the ECO TUB CLEAN cycle. This is normal, and not a system failure. To keep the tub clean, it is recommended to run the cycle once every 1-3 months.</li> </ul>

# Troubleshooting

Symptom	Action
Fills with the wrong temperature water.	<ul style="list-style-type: none"> <li>• Fully open both water taps.</li> <li>• Make sure the temperature selection is correct.</li> <li>• Make sure the hoses are connected to the correct water taps. Flush water lines.</li> <li>• Disconnect the hoses and clean the screens. The hose filter screens may be clogged.</li> <li>• While the washing machine fills, the water temperature may change as the automatic temperature control feature checks incoming water temperature. This is normal.</li> <li>• While the washing machine fills, you may notice just hot and/or just cold water going through the dispenser when cold or warm temperatures are selected. This is a normal function of the automatic temperature control feature as the washing machine determines the water temperature.</li> </ul>
Door (Lid) locked or will not open.	<ul style="list-style-type: none"> <li>• While the washing machine is operating, press or tap <b>START/PAUSE</b> to stop the washing machine.</li> <li>• It may take a few moments for the door lock mechanism to disengage.</li> </ul>
Does not drain and/or spin.	<ul style="list-style-type: none"> <li>• Check the fuse or reset the circuit breaker.</li> <li>• Make sure the electrical voltage is normal.</li> <li>• Make sure the washing machine is plugged in.</li> <li>• Make sure the drain hose is pointed downward. (Natural drain models only)</li> <li>• Make sure the drain hose is not clogged.</li> <li>• Make sure the drain hose is not kinked.</li> <li>• Straighten the drain hose. If there is a drain restriction, call for service.</li> <li>• Close the door, and press or tap <b>START/PAUSE</b>. For your safety, the washing machine will not spin unless the door is closed.</li> </ul>
Load is wet at the end of the cycle.	<ul style="list-style-type: none"> <li>• Use the High or Extra High spin speed. (Applicable model only)</li> <li>• Use high efficiency (HE) detergent to reduce oversudsing.</li> <li>• Load is too small. Small loads (one or two items) may become unbalanced and not spin completely.</li> </ul>

Symptom	Action
Leaks water.	<ul style="list-style-type: none"> <li>• Make sure all hose connections are tight.</li> <li>• Make sure the water supply hose's rubber packing is in the correct position. Screw tightly again.</li> <li>• Make sure the end of the drain hose is correctly inserted and secured to the drain system.</li> <li>• Avoid overloading.</li> <li>• Use high efficiency (HE) detergent to prevent oversudsing.</li> <li>• Make sure the water supply hose is not kinked.</li> <li>• If the water supply is too strong, water may leak. Close the water tap a little.</li> <li>• Make sure water is not leaking from the water tap. If so, repair the water tap.</li> </ul>
Excessive suds.	<ul style="list-style-type: none"> <li>• Use high efficiency (HE) detergent to prevent oversudsing.</li> <li>• Reduce the detergent amount for soft water, small loads, or lightly soiled loads.</li> <li>• Non-HE detergent is not recommended.</li> </ul>
The spin basket or drain/supply hose is frozen.	<ul style="list-style-type: none"> <li>• Use warm water to disconnect the water supply hose and drain hose. Soak them in warm water.</li> <li>• Fill the spin basket with warm water, and then wait for about 10 minutes.</li> <li>• Put a hot towel on the drain hose connector.</li> <li>• Reconnect the water supply hose and drain hose, and check if water is supplied properly.</li> </ul>
Water drains out immediately.	<ul style="list-style-type: none"> <li>• Make sure the drain hose is not clogged, and is hung over the drain hose hook. Fill the spin basket halfway with water, and try spinning again.</li> <li>• Lift the end of the drain hose to prevent water from draining. Fill the spin basket halfway with water, and then run spinning after releasing the drain hose.</li> <li>• Make sure the drain hose is installed correctly. See the installation section of this user manual and adjust the position of the drain hose as instructed.</li> </ul>
Stains on clothes.	<ul style="list-style-type: none"> <li>• Clean the lint filter.</li> </ul>
Has odours.	<ul style="list-style-type: none"> <li>• Excessive suds collect in recesses and can cause foul odours.</li> <li>• Run cleansing cycles to sanitize periodically.</li> <li>• Dry the washing machine interior after a cycle has finished.</li> </ul>

If a symptom continues to happen, contact a local Samsung service centre.

# Troubleshooting

## Information codes

If the washing machine fails to operate, you may see an information code on the display. Check the table below and try the suggestions.

Code	Action
5C	<p><b>Water does not drain.</b></p> <ul style="list-style-type: none"> <li>• Make sure the drain hose is not bent, frozen, or clogged.</li> <li>• If the water does not drain in 30 minutes, an alarm will sound with the information code of "5C" on the display.</li> </ul>
4C	<p><b>Water is not supplied.</b></p> <ul style="list-style-type: none"> <li>• Make sure the water tap is opened.</li> <li>• Make sure the water hose is not bent, frozen, or clogged.</li> <li>• If the water supply is not finished in 1 hour or the water level does not change in 4-10 minutes after the water supply has started, an alarm will sound with the information code of "4C" on the display.</li> </ul>
Ub	<p><b>The spinning process does not operate.</b></p> <ul style="list-style-type: none"> <li>• Make sure the laundry is spread out evenly in the tub.</li> <li>• Make sure the washing machine is levelled on a flat surface.</li> </ul>
1C, OC	<p><b>Water overflows.</b></p> <ul style="list-style-type: none"> <li>• Run the spinning process to drain water, and restart the machine.</li> <li>• If the information code continues to appear, call for service.</li> </ul>
CL, dC	<p><b>Child Lock is activated unexpectedly.</b></p> <ul style="list-style-type: none"> <li>• While the information code blinks at a 0.5 second intervals, water drains with an alarm.</li> <li>• To clear the information code, close the door when draining is complete, and then restart the washing machine by pressing the <b>START/PAUSE</b> button.</li> </ul>
LC	<ul style="list-style-type: none"> <li>• Check if the end of the drain hose is placed on the floor. (The hose should be hung over the pump - hose guide.)</li> <li>• Check if the drain hose is clogged by any foreign substances.</li> <li>• If the error remains, call the customer care.</li> </ul>
8C	<p><b>Check the MEMS sensor.</b></p> <ul style="list-style-type: none"> <li>• Power the washer off. Wait 2-3 minutes, power the washer on, and then try again.</li> <li>• If the problem continues, call for service.</li> </ul>
9C1	<p><b>The electronic control needs to be checked (Over Voltage Error).</b></p> <ul style="list-style-type: none"> <li>• Check if power is supplied properly.</li> <li>• Turn off the washer, unplug it, wait one minute, and then plug the washer in again. If the information code remains, contact a Samsung customer service center.</li> </ul>
9C2	<p><b>Low voltage detected.</b></p> <ul style="list-style-type: none"> <li>• Check if the power cord is plugged in.</li> <li>• Turn off the washer, unplug it, wait one minute, and then plug the washer in again. If the information code remains, contact a Samsung customer service center.</li> </ul>

If any information code keeps appearing on the screen, contact a local Samsung service centre.



# Specifications

## Specification sheet

Type		Top loading washing machine	
		WA75T45****	WA75T42****
Max load (kg)		7.5	
Power consumption (W)	AC 220-240 V / 50 Hz	200-250 W	
Dimensions (mm)		W540×D568×H1015	
Net weight (kg)		30.5	30
Water pressure (Mpa (kg-f/cm <sup>2</sup> ))		0.05 - 0.78 (0.5 - 8.0)	
Washing type		Stirring type	
Water level (L)	5	62	
	4	58	
	3	49	
	2	40	
	1	33	
Water usage (L)		160	
Spin speed (rpm)		700	

Type		Top loading washing machine	
		WA70T45****	WA70T42****
Max load (kg)		7.0	
Power consumption (W)	AC 220-240 V / 50 Hz	200-250 W	
Dimensions (mm)		W540×D568×H1015	
Net weight (kg)		30	29.5
Water pressure (Mpa (kg-f/cm <sup>2</sup> ))		0.05 - 0.78 (0.5 - 8.0)	
Washing type		Stirring type	
Water level (L)	5	62	
	4	58	
	3	49	
	2	40	
	1	33	
Water usage (L)		160	
Spin speed (rpm)		700	

### NOTE

- Asterisk (\*) means variant model and can be varied (0-9) or (A-Z).
- The design and specifications are subject to change without notice for quality improvement purposes.

"The energy label specifications have been determined by using following program according to IEC 60456

- The program is

- WA75T45\*\*\*\* : Energy saving course, Water Level 5
- WA75T42\*\*\*\* : Energy saving course, Water Level 5
- WA70T45\*\*\*\* : Energy saving course, Water Level 5
- WA70T42\*\*\*\* : Energy saving course, Water Level 5

# Specifications

Type		Top loading washing machine	
		WA65T45****	WA65T42****
Max load (kg)		6.5	
Power consumption (W)	AC 220-240 V / 50 Hz	200-250 W	
Dimensions (mm)		W540×D568×H995	
Net weight (kg)		30	29.5
Water pressure (Mpa (kg·f/cm <sup>2</sup> ))		0.05 - 0.78 (0.5 - 8.0)	
Washing type		Stirring type	
Water level (L)	5	62	
	4	58	
	3	49	
	2	40	
	1	33	
Water usage (L)		160	
Spin speed (rpm)		700	

## NOTE

- Asterisk (\*) means variant model and can be varied (0-9) or (A-Z).
- The design and specifications are subject to change without notice for quality improvement purposes.

"The energy label specifications have been determined by using following program according to IEC 60456

- The program is

WA65T45\*\*\*\* : Energy saving course, Water Level 5

WA65T42\*\*\*\* : Energy saving course, Water Level 5

# Terms of Warranty

---

## Warranty not applicable in any of the following cases

---

- 1.** The Complete warranty Card is not presented to the service engineer at the time of repairs being undertaken/ requested.
- 2.** The Product is not purchased from an Authorized Samsung Sales Dealer.
- 3.** The Product purchased is not used according to the instruction given in the INSTRUCTION MANUAL as determined by company personnel.
- 4.** Defect Caused by improper use, as determined by the authorized service centers/ Company Personnel.
- 5.** Modification or alterations of any nature made in the circuitry by the Purchaser or unauthorized Personnel, as determined by Company personnel.
- 6.** The Warranty is not applicable if the washing machine used for commercial purpose or Public places like Hotels, training centers and other similar applications.
- 7.** The Original Serial number is removed, obliterated or altered from the Product.
- 8.** Defect due to causes beyond control like lightening, abnormal voltage, acts of god or while in transit to service center or to the purchaser residence.
- 9.** Correcting the installation for example leveling the product, adjustment of drain hose, Adjustment of Tap adopter.
- 10.** Noise or Vibration that is considered as normal for example water drain sound, spin sound or warning beeps.
- 11.** Removal of foreign objects/substances from machine, including the Drain Valve and inlet hose filter for example coin, Grit, safety pin, buttons, hooks, Dirt accumulation etc.
- 12.** Replace fuse, correcting house wiring, house plumbing and defect or damage caused by household pets, rats, cockroaches or any other animals or insects.

For warranty conditions refer warranty card.

**QUESTIONS OR COMMENTS?**

COUNTRY	CALL	OR VISIT US ONLINE AT
INDIA	1800 40 SAMSUNG (1800 40 7267864)(Toll-Free) 1800 5 SAMSUNG (1800 5 7267864)(Toll-Free)	<a href="http://www.samsung.com/in/support">www.samsung.com/in/support</a>



This product is RoHS compliant.

DC68-04142A-00