

MOZA AIR2S

User Manual
用户手册

Contents

■ Packing List	1
■ MOZA Air 2S Overview	3
■ Air 2S Installation.....	4
• Attaching the Tripod	4
• Battery startup and shutdown	4
• Mounting the Camera	5
• Connecting Camera Control Cable	6
• Installing the Support Rod	6
■ Balance Adjustment	7
• Balancing the Camera	7
• Balancing the Tilt Axis	7
• Balancing the Roll Axis	8
• Balancing the Pan Axis	8
■ Buttons and OLED Display	9
• Button Functions	9
• Main Interface	9
• Menu Description	10
■ Features Description	12
• Camera Control.....	12
• Motor Output.....	14
• FPV,Sport Gear Mode	15
• Manual Positioning	16
• Button Customization.....	16
• Inception Mode.....	16
• Balance Check	17
• Sensor Calibration	18
• Language Switch	19
• User Configuration	19
■ Management	20
• Smartphone and PC connection	20
• Install the Phone Holder	20
• FirmwareUpgrade	20
■ SPECS.....	21

目录

■	包装清单	22
■	认识Air 2S	24
■	安装Air 2S	25
	• 三脚架的安装和使用	25
	• 电池的启动和关闭	25
	• 相机的安装和拆卸	26
	• 相机控制线的安装	27
	• 跟焦安装管的安装和拆卸	27
■	平衡调节	28
	• 快装板前后调节	28
	• 俯仰臂调节	28
	• 横滚臂调节	29
	• 航向臂调节	29
■	按键操作和屏幕显示	30
	• 按键定义	30
	• 屏幕显示	31
	• 菜单说明	32
■	功能说明	34
	• 相机控制	34
	• 电机出力	36
	• 跟随模式、态极、极速跟随	37
	• 手动定位	38
	• 按键自定义	38
	• 盗梦空间	38
	• 平衡检查	39
	• 传感器校准	40
	• 切换显示语言	41
	• 用户配置管理	41
■	扩展使用	42
	• 连接智能手机或电脑	42
	• 安装手机支架	42
	• 固件升级	42
■	规格参数	43

Packing List

Check that all of the following items are in your package. If any item is missing, please contact MOZA or your local dealer.

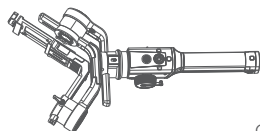

x1

Gimbal



x1

Tripod

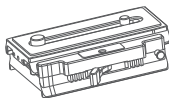

x1

Quick Release System

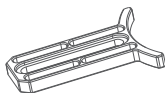

x1

Lens Support

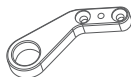

x1

Support Rod Adapter



x2

M3 Screw



x1

H2 L-Allen Wrench



x1

Disassembly spanner

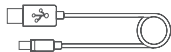

x1

USB-C Cable



x1

M3C-Micro

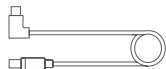

x1

M3C-Mini

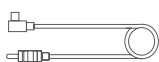

x1

MCSC-Remote



x1

MCSC-Multi



x1

MCSC-Multi/C



x2

Follow Focus Support Rod



x1

Lens Support Screw



x1

Storage Case



x1

Tool Box



x1

User Manual

MOZA Air 2S Overview

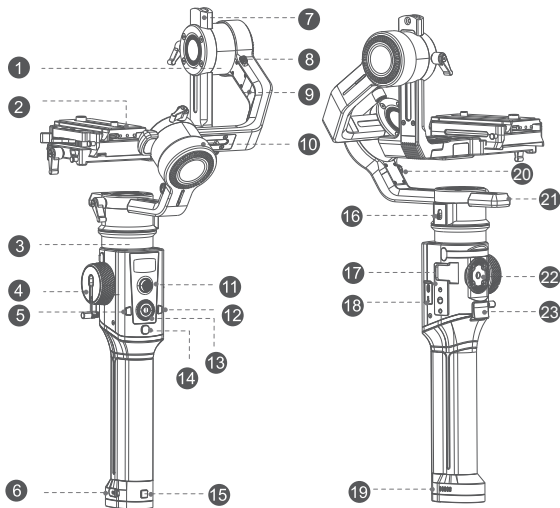

- | | | | |
|--|-------------------|---|----------------------------|
| 1 Tilt Motor | 7 Tilt Arm | 13 Dial | 19 Battery Indicator Light |
| 2 Mechanical Memory Quick Release System | 8 Tilt Motor Lock | 14 Power Button | 20 Roll Motor Lock |
| 3 Pan Motor | 9 Roll Arm | 15 Battery on/off Button | 21 Pan Arm |
| 4 Wheel | 10 Roll Motor | 16 Pan Motor Lock | 22 1/4"Extension Port |
| 5 M Button | 11 Joystick | 17 Extension Port | 23 Smart Trigger |
| 6 Type-C Port | 12 S Button | 18 Adjust parameters and firmware upgrade interface | |

Air 2S Installation

Attaching the Tripod

2 screw holes are equipped at the bottom of grip: 1/4" for mini tripod and 3/8" for large accessories like slider and big tripod. Screw the mini tripod, then expand as shown below.

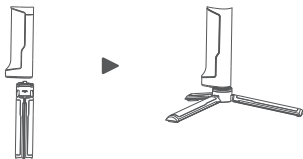

Battery startup and shutdown



- Long press the power button,
- Press the power button of battery, then long press the power button again three seconds later. After the battery indicator lights turn off from left to right, release the battery on key and the battery will turn off.
- When the battery is in the off state of PTZ, it will automatically turn off 10 minutes later. To start the PTZ, you need to turn on the battery first.

! It is recommended to press the on / off key of the stabilizer for a long time to turn off the stabilizer, and then turn off the battery according to the operation when shutting down.

Mounting the Camera

The Air 2S quick release plate is equipped with 2 screws, select an appropriate one according to the camera type. There is no limit to the installing direction of the quick release plate. When mounting the camera, make sure the lens slightly extends beyond the quick release plate in order to reserve extra room for lens support and rod adaptor

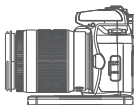

- After mounting the camera onto the quick release plate, loosen the lever A, then slide the quick release plate onto the baseplate. The quick release plate can be installed from both back and forth.
- Please make sure the safety lock 1 and 2 will eject once each, and a rough back and forth balance is reached.



- Press the safety lock 1, the quick release plate will be removed in the direction shown below.

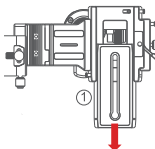

- Press the safety lock 1, slide the plate as shown below, then press the lock 2 when the plate is moved to the end. The quick release plate will be removed in the reverse direction.

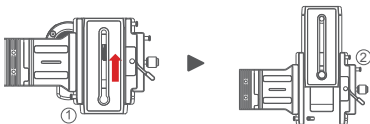

⚠ Note: It is recommended to use the lens support for the best effect.

Connecting Camera Control Cable

4 different control cables are stored in the tool box

- a. M3C-Mini cable: For cameras with Mini port like Canon 5D3, etc
- b. M3C-Micro cable: For cameras with Micro port like Canon 5D4, etc
- c. MCSC-Remote cable: For Panasonic cameras with 2.5mm port like GH3, GH4, etc
- d. MCSC-Multi cable: For Sony cameras with Multi port like A7s II , A7 III , etc
- e. MCSC-Multi/C cable: For Sony cameras with Multi port and USB power supply like A7s II , A7 III , etc

Connect the control cable to the CAM CTRL port on the Air 2S gimbal, and then the other end to the control port on the camera. The camera icon will be displayed on the OLED screen. Then parameters adjusting, video recording or photo taking, and follow focus can be directly operated on the gimbal.

⚠ Note:

1. For details of different cameras and lenses, please refer to 'Camera Control'.
2. If USB control is not supported, the camera icon won't display on the screen, please choose your camera control protocol manually.

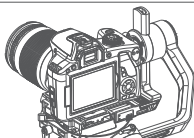

Installing the Support Rod

Please install the rod before using the follow focus.

Take out the rod adaptor, M3x10 screws, Allen wrench first. Fix the adaptor on the front or back of the quick release plate with M3x10 screws, then revolve the support rod into the adaptor.

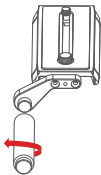

When installed at the left side, please match the stud of the rod adaptor and the screw hole of the support rod, then tighten the support rod counterclockwise.

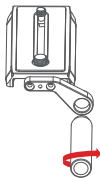

When installed at the right side, please match the screw hole of the rod adaptor and the stud of the support rod, then tighten the support rod clockwise.

⚠ Note: 1. Please install the support rod and rod adaptor according to the position shown above for fear of falling off. 2. Can't assemble 2 support rods together as extending use

Balance Adjustment

⚠ Attention: Balance Adjustment can refer to the function of Air 2S' balance check, and it will be more convenient to adjust according to the instructions of check.

⚠ Attention: If the roll arm is locked at the overlapping position with the heading arm, please unlock the roll motor first, and do not drag it by force.

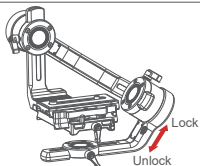

Balancing the Camera

- Mount the camera onto the Air 2S, release hands to check the direction of camera
- If lens is tilted upward, then the camera position is backward. Loosen quick release base and tighten the knob, move the quick release plate until lens points to frontage.
- If lens is tilted downward, then the camera position is forward. Loosen quick release base and tighten the knob, move the quick release plate until lens points to frontage.
- Tighten the quick release base and knob.



Balancing the Tilt Axis

- Rotate the camera so that the lens is pointing upward, release hands to check the direction in which the camera swings.
- Loosen the knob 1 on the tilt motor to slide the tilt arm 2 until the camera stays still without tilting it up or down.
- Tighten the knob 1.

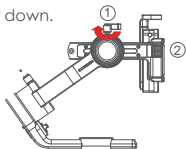

Balancing the Roll Axis

- Move the roll motor lock switch to the unlock end.
- Release hands to observe the direction in which the roll axis swings.
- Loosen the roll axis knob 1 to slide the roll arm 2 until the roll arm 2 stays still.
- Tighten the knob 1.

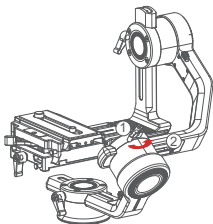

Balancing the Pan Axis

- Grab the Air 2S horizontally, make the pan arm level. Release hands to check the direction in which the camera swings.
- Loosen the knob 1 on the pan motor. Move the pan arm 2 leftwards or rightwards until it keeps level.
- Tighten the knob 1.

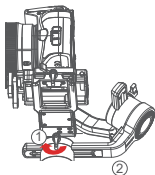

⚠ Note: If the balance of the pan axis is not adjusted properly, the pan axis may become hot, and the inception mode cannot be used properly.







Buttons and OLED Display

Button Functions:

Button	Operation	Function	Customizable Function						Menu
Trigger	1 X	—	N/A	Focus	Shutter	—	—	—	The same
	2 X	Re-Center	N/A	Re-Center	Selfie	—	—	—	The same
	3 X	Selfie	N/A	Re-Center	Selfie	—	—	—	The same
Power Button	Press	Pan-Tilt Follow	N/A	Pan-Tilt Follow	All lock	Sport gear mode	FPV mode	—	The same
	1 X	Video recording	—	—	—	—	—	—	The same
	2 X	Take photo	—	—	—	—	—	—	The same
	3s	ON/OFF	—	—	—	—	—	—	The same
Wheel	Turn	Pan axis	Focus motor1	Focus motor 2	E-focus	Tilt axis	Roll axis	—	The same
M Button	1 X	Switch wheel modes	—	—	—	—	—	—	The same
S Button	1 X	Sport gear mode	—	—	—	—	—	—	The same
	2 X	Inception mode	—	—	—	—	—	—	The same
	3 X	FPV mode	—	—	—	—	—	—	The same
	3s	Auto tune	—	—	—	—	—	—	The same
Joystick	Push Up-Down	Move the tilt axis	Tilt axis	Roll axis	Pan axis	—	—	—	The same
	Push Left-Right	Move the pan axis	Tilt axis	Roll axis	Pan axis	—	—	—	The same
Top	1 X	TV	—	—	—	—	—	—	Option-up
	2 X	Tilt follow	—	—	—	—	—	—	—
Down	1 X	AV	—	—	—	—	—	—	Option-down
	2 X	Pan follow	—	—	—	—	—	—	—
Left	1 X	ISO	—	—	—	—	—	—	Return
	2 X	Roll follow	—	—	—	—	—	—	—
Right	1 X	Enter/Exit preview	—	—	—	—	—	—	Confirm/Next menu
Menu Button	1 X	Enter the menu	—	—	—	—	—	—	The same
	3 X	Language	—	—	—	—	—	—	The same
	3s	Sleep/wake up	—	—	—	—	—	—	The same
Dial	Turn	Follow speed	—	—	—	—	—	—	Adjust relevant
Combo	Menu+Power	Upgrade mode	—	—	—	—	—	—	—

Main interface

A: Smart wheel working modes

-  Controlling external follow focus motor 1
-  Controlling external follow focus motor 2
-  Electronic follow focus
-  Controlling the tilt axis
-  Controlling the roll axis
-  Controlling the pan axis

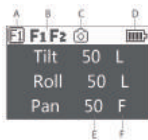

B: Focus motor connection status. Icon will be displayed after connection, otherwise it won't be displayed. Up to two focus motors can be connected at the same time.

C: Camera connection status. Icon will be displayed after USB connection, otherwise it won't be displayed.

D: Battery quantity. Each grid represents 25% battery level. When the battery is empty, please charge the battery in time.

E: Follow speed value: 0-100. Turn the dial to adjust the value

F: Follow status

- L: Lock. The axis locks and doesn't follow.
- F: Follow. The axis follows.
- Q: Sport Gear Mode

Menu Description

L1	L2	L3	L4	L5	Value	Function			
camera	Choice	Shutter Cable			*	set the connection type to universal shutter cable			
		MCSC-Multi			*	set the connection type to Sony-Multi port			
		MCSC-Multi/C			*	set the connection type to Sony-Multi port and power supply			
		MCSC-Remote			*	set the connection type to Panasonic-Remote port			
		M3C-USB			*	set the connection type to USB port			
	Parameters	ISO				32--106400	Set the camera ISO		
TV					30--1/8000	Set the camera shutter			
AV					F1--F22	Set the camera aperture			
gimbal	motor	switch				? /ok	turn on/off motor		
							? /ok	tuning/tuned	
		power	level		autotune				
					ultra light	*			set motor level to the minimum
					light	*			set motor level to light
					medium	*			set motor level to medium
					heavy	*			set motor level to heavy
				ultra heavy	*			set motor level to ultra heavy	
			custom		tilt		0-100	set tilt motor power	
				roll		0-100	set roll motor power		
				pan		0-100	set pan motor power		
		filter		tilt			0-100	set tilt motor filter	
				roll			0-100	set roll motor filter	
				pan			0-100	set pan motor filter	
		follow	switch		tilt		on/off	enter/exit tilt follow mode	
				roll		on/off	enter/exit roll follow mode		
				pan		on/off	enter/exit pan follow mode		
	speed			tilt			0-100	set the following speed of tilt motor	
				roll			0-100	set the following speed of roll motor	
				pan			0-100	set the following speed of pan motor	
	deadband			tilt			0-100	set the following initiation angle of tilt motor	
				roll			0-100	set the following initiation angle of roll motor	
				pan			0-100	set the following initiation angle of pan motor	
	operation		joystick	function		tilt/rol/pan			left-right tilt/rol/pan up-down tilt/rol/pan
						tilt/rol/pan			move the joystick left/right to control the tilt/roll/pan rotation
				sensitivity		left-right		0-100	
					up-down		0-100		set sensitivity level of up-down movement
		habits			left-right		+/-		set the control habit of joystick left/right movement
					up-down		+/-		set the control habit of joystick up/down movement
		wheel	function		focus-1	*		control the external focus motor 1	
					focus-2	*		control the external focus motor 2	
					focus-e	*		control the electronic focus	
					tilt	*		control the pan axis	
					roll	*		control the tilt axis	
					pan	*		control the roll axis	
			sensitivity			0-100		wheel sensitivity	
			habits			+/-		set the control direction of wheel rotation	
		trigger	press		none	*		none	
				follow	*		enter pan-tilt follow mode		
				lock	*		enter all lock mode		
				quick	*		enter sport gear mode		
				FPV	*		enter FPV mode		
click			none	*			none		
			shutter	*			take photo		
			focus	*			auto focus		
double-click			none	*			none		
			re-center	*			re-center		
			selfie	*			rotate the gimbal 180° for selfie		
triple-click			none	*			none		
		re-center	*			re-center			
	selfie	*				rotate the gimbal 180° for selfie			

L1	L2	L3	L4	L5	Value	Function		
gimbal	operation	dial	habits		+/-	rotate the dial clockwise to increase/decrease value		
	autotune				? /ok	auto tune		
advanced	balance check					check the balance state of camera		
	iFocus	F1	switch			? /ok/err	turn on/off the focus motor 1	
			set A			? /ok/err	set the point A of focus motor 1	
			set B			? /ok/err	set the point B of focus motor 1	
			Clear AB			? /ok/err	Clear the calibration information	
			Guidance			>	Enter the guidance mode	
		F2	switch				? /ok/err	turn on/off the focus motor 1
			set A				? /ok/err	set the point A of focus motor 1
			set B				? /ok/err	set the point B of focus motor 1
			Clear AB				? /ok/err	Clear the calibration information
			Guidance				>	Enter the guidance mode
	Dolly Zoom				>	Enter the dolly zoom mode		
	inception	speed				0-100	set the rotation speed of inception mode	
	motion control	switch	tilt			? /on/off	turn on/off the motion control of tilt axis	
			roll			? /on/off	turn on/off the motion control of roll axis	
			pan			? /on/off	turn on/off the motion control of pan axis	
		speed				0-100	set the rotation speed of motion control	
tracking	speed				0-100	set the max speed of tracking		
manual positioning	tilt				on/off	turn on/off the manual positioning of tilt axis		
	roll				on/off	turn on/off the manual positioning of roll axis		
	pan				on/off	turn on/off the manual positioning of pan axis		
calibration	gyro				? /ok	calibrating/calibrated the gyroscope		
	acc				? /ok	calibrating/calibrated the accelerometer		
	angle offset	tilt				0-100	set the offset value of tilt axis	
		roll				0-100	set the offset value of roll axis	
		pan				0-100	set the offset value of pan axis	
general	language	English			*	switch display language to English		
		中文			*	switch display language to Chinese		
	config	config1	save			? /ok	save to configuration 1	
			load			? /ok	load configuration 1	
		config2	save			? /ok	save to configuration 2	
			load			? /ok	load configuration 2	
		config3	save			? /ok	save to configuration 3	
			load			? /ok	load configuration 3	
	reset				? /ok	restore default parameter settings		
	about					device name and firmware information		

Menu type introduction:

If there is a ">" mark at the right side of the selected item, press the dial right button for the next menu.

If the selected item has a "[]" and contains a number, rotate the dial to adjust its value.

If the selected item has a "()" and contains an option, press the right button to switch among options.

Notes:

1. If there is a "*" at the right side of one item, the current list is the final option, press the dial right button to launch it.
2. If the selected item and other items in the menu list don't have any marks, press the dial right button to launch the option once. ">" is displayed during the process. "OK" is displayed after the process is completed, and "ERR" is displayed if the option fails.

- ⚠ 3. Filtering parameters: When the motor vibrates with high frequency, the value should be turned down. When the motor vibrates with low-frequency, the value should be increased.
4. The manual positioning function has lower priority than the following function. When using manual positioning function normally, following function of the axis should be turned off.

Features Description

Camera Control

The Air 2S can support camera video recording, photo taking and electronic focus control. Please refer to the compatibility list for more details

(* Please set the lens to "MF" mode)

Brand	Model	Select	Cable	Shutter	Record	ISO	TV	AV	Auto Focus	Focus Control	Power Supply		
CANON	EOS R	M3C-USB	M3C-Micro+ Micro to Type-C Adapter (optional)	√	√	√	√	√	√	√	—		
	EOS RP			√	√	√	√	√	√	√	—		
	EOS 6D Mark II			*	√	√	√	√	√	√	—		
	EOS 6D		M3C-Mini	M3C-Micro	*	√	√	√	√	√	√	—	
	EOS 60D				*	√	√	√	√	√	√	—	
	EOS 70D				*	√	√	√	√	√	√	—	
	EOS 77D				*	√	√	√	√	√	√	—	
	EOS 80D				*	√	√	√	√	√	√	—	
	EOS S20				*	√	√	√	√	√	√	—	
	EOS S203				*	√	√	√	√	√	√	—	
	EOS 800D				*	√	√	√	√	√	√	—	
	EOS 5D Mark IV				*	√	√	√	√	√	√	—	
	EOS 200D II		*	√	√	√	√	√	√	—			
	EOS M50		MCSC-C1	C1 Shutter Cable (optional)	*	√	√	√	√	√	√	—	
	EOS M5				√	—	—	—	—	—	—	—	
Alpha 7S	—	√			√	√	√	√	√	—			
Alpha 7R	M3C-USB	M3C-Micro	—	√	√	√	√	√	√	—			
Alpha 6300			—	√	√	√	√	√	√	—			
Alpha 6400			—	√	√	√	√	√	√	—			
Alpha 6500			—	√	√	√	√	√	√	—			
Alpha 7S II			—	√	√	√	√	√	√	—			
Alpha 7R II			—	√	√	√	√	√	√	—			
Alpha 7 II			—	√	√	√	√	√	√	—			
Alpha 7 III			—	√	√	√	√	√	√	—			
Alpha 7R III			—	√	√	√	√	√	√	—			
DSC-RX100M3			—	√	√	√	√	√	√	—			
DSC-RX100M4			—	√	√	√	√	√	√	—			
DSC-RX100M5			—	√	√	√	√	√	√	—			
Alpha 7S			MCSC-Multi	MCSC-Multi	√	√	—	—	—	√	—	√	
Alpha 7R					√	√	—	—	—	√	—	√	
Alpha 6300					√	√	—	—	—	√	—	√	
Alpha 6400	√	√			—	—	—	√	—	√			
Alpha 6500	√	√			—	—	—	√	—	√			
Alpha 7S II	√	√			—	—	—	√	—	√			
Alpha 7R II	√	√			—	—	—	√	—	√			
Alpha 7 II	MCSC-Multi/C	MCSC-Multi/C			√	√	—	—	—	√	—	√	
Alpha 7 III					√	√	—	—	—	√	—	√	
Alpha 7R III					√	√	—	—	—	√	—	√	
DSC-RX100M3					√	√	—	—	—	√	—	√	
DSC-RX100M4					√	√	—	—	—	√	—	√	
DSC-RX100M5					√	√	—	—	—	√	—	√	
Panasonic	DMC-G7K GK	MCSC-Remote			MCSC-Remote	√	√	—	—	—	√	—	—
	DMC-G85 GK					√	√	—	—	—	√	—	—
	DMC-GH3		√	√		—	—	—	√	—	—		
	Lumix GH4		√	√		—	—	—	√	—	—		
	DC-S1 GK-K		√	√		—	—	—	√	—	—		
	Lumix GH5		√	√		√	√	√	√	√	√	—	
DC-GH5SGK-K	√	√	√	√	√	√	√	√	—				
Nikon	Z6	M3C-USB	M3C-Micro+ Micro to Type-C Adapter (optional)	√	√	√	√	√	√	√	—		
	Z7			√	√	√	√	√	√	√	—		
	D850			√	√	√	√	√	√	√	—		
FUJIFILM	X-T2	MCSC-C1	C1 Shutter Cable (optional)	√	√	—	—	—	√	—	—		
	X-T3			√	√	—	—	—	√	—	—		
	X-T20			√	√	—	—	—	√	—	—		
	X-T30			√	√	—	—	—	√	—	—		
	X-T30			√	√	—	—	—	√	—	—		

Note: please refer to the official website for the latest camera control list.

Operation Steps:

- a. Long press the center button to enter the menu, refer to the compatibility list to select the correct camera type.

b. Refer to the list to choose and connect the camera control cable. Connect the Mini-USB end of the control cable to the control port of Air 2S. Connect the other end to the corresponding control port of the camera.

c. You can achieve recording by clicking the menu button one time and taking photos by clicking menu button twice after selecting the camera type and connecting the camera control cable.

Note:

1. Cameras equipped with Micro USB 3.0 interface, such as the Nikon D850, can be normally controlled by half plugging the M3C-Micro cable.



2. After plugging the camera control cable, please operate the camera according to the prompts on the camera screen, otherwise the camera control function may not work properly.

- Start/Stop: Press power button once
- Shoot photos: Press power button twice
- Adjust shutter: Press the up button of the dial (TV)
- Adjust aperture: Press the down button of the dial (AV)
- Adjust ISO: Press the left button of the dial (ISO)

When adjusting camera parameters, press the corresponding button and the screen will display the value, then turn the dial to adjust the value. After the adjustment is completed, press the corresponding button again to turn off the adjustment of camera parameters.

- Turn on/ off preview: press the right button of the dial to turn on or off live preview.



Note:

1. Only when start camera settings can turn the dial adjust parameters. Under the default state, turn the dial would adjust the follow speed.

2. Some cameras with sensor, like Sony A7S2 will shut down the screen and switch to viewfinder for preview, if there is obstruction before the viewfinder. Set preview setting to screen

Motor Output

The payload of Air 2S is from 300g to 4200g. Different payload requires different motor power to achieve the best stability. There are three methods for adjusting the output of the motor:

Auto-tuning operation method:

- Install the camera and adjust the balance
- Unlock all motor lock
- Turn on the stabilizer, long press the center button to enter the menu, select 'Gimbal' > 'Motor' > 'Power' > 'Auto-tune'
- During the auto-tuning, the stabilizer will vibrate automatically to match the most suitable output value. Wait for about 5 seconds, the stabilizer stops shaking, and the auto-tuning completes.

camera	>	motor	>	switch		autotune	
gimbal	>	follow	>	power	>	level	>
advanced	>	operation	>	filter	>	custom	>
general	>						

Set the output gear:

Factory default presets 5 groups of motor output values, which are suitable for cameras of different weight levels.

Customize the output value of each motor:

The users can customize the output value of each motor to reach more precise control of the motor output. The adjustment range is 0 to 100.

Note:

- Under the camera lens combination of the limit, the auto-tuning function may not accurately calculate the appropriate output value. Please manually adjust the motor output according to the situation.
- If the motor output is too low, the video is not stable enough; if the motor output is too high, it will cause high-frequency vibration of the stabilizer.
- When the motor output is at the critical value, the stabilizer will not vibrate in the upright state, but it will vibrate in the forward or inverted state. Please reduce the motor output moderately.

FPV, Sport Gear Mode

When the follow function is enabled, the camera will follow the movement of the gimbal. Users can enable the follow mode of each axis through dial buttons and turn the dial to adjust the following speed, which can be also enabled in the menu.

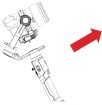
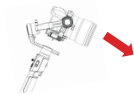
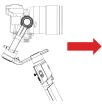
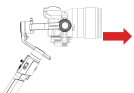
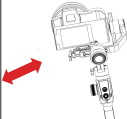
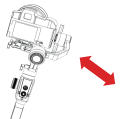
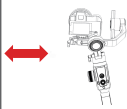
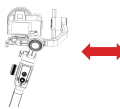
Follow Mode Switch	Example 1	Example 2
Enter the tilt follow		
Exit the tilt follow		
Enter the roll follow		
Exit the roll follow		

⚠ Note:

1. The Air 2S is in pan follow mode by default.
2. In addition to controlling the follow mode by the switches of each axis independently, follow modes can be also enabled by the trigger, please refer to 'Button Functions' for more details.
3. The angle of the roll follow is 45°. For a larger following angle, please triple click the left button to enter the FPV mode to achieve 360° follow of three axes.
4. If faster following speed is required, please click the right button to enter the sport gear mode. (Currently only supports the pan axis)

Manual Positioning

Manual positioning is used to quickly adjust the direction of the camera. When the function of manual positioning is enabled, the camera orientation can be adjusted by hand which will not automatically return to the initial position. The adjustment speed is faster than using the joystick or the following mode. The manual positioning of the tilt axis is enabled by default on the Air 2S. Manual positioning of the roll and pan axes can be enabled in the menu.

camera >	balance chk	tilt [off]	tilt [on]
gimbal >	iFocus >	roll [off]	roll [off]
advanced >	inception >	pan [on]	pan [on]
general >	manual pos >		

! Note: The follow function has higher priority than manual positioning. When the follow function of any axis is on, the manual positioning function cannot be used. Only after the follow function is off, the manual positioning can be used normally.

Button Customization

Button Customization is used to specify the function, sensitivity and operation direction of each button according to the user's habits.

For Example:

By default, moving the joystick up and down controls the tilt axis rotation. It can be changed to control the roll or pan axis rotation by customizing;

By default, moving the joystick left and right controls the pan axis rotation. It can be changed to control the tilt or roll axis rotation by customizing.

camera >	motor >	joystick >	function >	left-right [pan]
gimbal >	follow >	wheel >	sensitivity >	up-down [tilt]
advanced >	operation >	trigger >	habits >	
general >		dial >		

The higher the sensitivity of the button, the more sensitive and faster the control is. If you change the 'custom' to -, the direction of operation will be opposite. For more button customization, please refer to 'Menu Description'.

Inception Mode

The Inception Mode is used to control the camera to rotate in the roll direction for shooting upside down and rotating footages. In the main interface, triple click the right button to enter the Inception Mode. After entering the Inception Mode, the camera lens is vertically up and each axis automatically follows.

Button Definition for Inception Mode:

- Turn the joystick left or right: the gimbal turns to left or right, when

release or turn to a specified angle, the gimbal stops.

- Turn the dial: adjust the rotation speed
- Press the left button on the dial once: the gimbal rotates to the left automatically. If the gimbal is rotating, press once to stop.
- Press right button on the dial once: the gimbal rotates to the right automatically. If the gimbal is rotating, press once to stop.
- Press up/down button on the dial: select rotation angle
- Normal: gimbal rotates and does not stop automatically
- 180: the gimbal rotates 180° and stops automatically.
- 360: the gimbal rotates 360° and stops automatically.

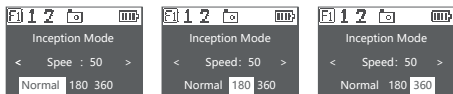

Triple click the right button again to exit the Inception Mode.

Balance Check

The gimbal can check the balance status of tilt and roll axis automatically and instruct users to make the correct adjustment.

- Attach a tripod to the gimbal, turn on the gimbal and place it on a horizontal tabletop.
- Enter the menu, select advanced>balance chk, the gimbal begins to check the balance adjustment.



- When balance check is completed, the balance status of each axis will be displayed on the screen, direction guide will be also displayed if the adjustment is needed.
- 'C' means quick release plate, 'T' means tilt axis, 'R' means roll axis, then start the adjustment according to the screen prompts.
- When adjustment is completed, press the right button and check it again until the gimbal is well balanced.

⚠ Note:

- Balance check can be only used with the tilt and roll axis, the pan axis balance cannot be checked, please check the pan axis manually. Be sure that the motor lock has been released when using balance check.
- Motors turned off after balance check, please long press 'menu' button to start the gimbal.

Sensor Calibration

● Gyroscope Calibration

Turn on the gimbal and leave it quietly for 5 minutes, the gyroscope calibration is required when the gimbal drifts obviously.

The steps are as follows:

- Turn on the gimbal (long press the power button)
- Turn off the motors (double press the power button/enter the menu, select gimbal>motor>switch, set 'off')
- Place air 2S on a horizontal table so that the platform is completely horizontal, keep the stabilizer stationary, and do not wiggle or tilt the stabilizer.
- Enter the menu, select advanced>calibrate>Gyro cali and press the dial right button, wait about 5 seconds, when the '?' changes to 'OK', the calibration is completed.

camera >	iFocus >	gyro >	gyro ok
gimbal >	inception >	acc >	acc >
advanced >	manual pos >	angle offset >	angle offset >
general >	calibration >		

● Accelerometer Calibration

Turn on the gimbal and there is no obvious drift, the accelerometer calibration is required when the camera doesn't keep level. The steps are as follows:

- Turn on the gimbal (long press the power button)
- Turn off the motors (double press the power button/enter the menu, select gimbal>motor>switch, set 'off')
- Leave the L-shaped quick release plate on the horizontal table. Avoid the bottom screw and keep the Air 2S at static position. Do not shake the it or tilt it. (or mount the camera to refer to its level)
- Enter the menu, select advanced>calibrate>Acc cali, and press the dial right button to enter calibration. Wait about 5 seconds, when the '?' changes to 'OK', the calibration is completed.

camera >	iFocus >	gyro >	gyro >
gimbal >	inception >	acc >	acc ok
advanced >	manual pos >	angle offset >	angle offset >
general >	calibration >		

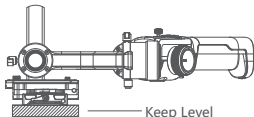

⚠ Note:

- Please keep the gimbal stationary during the calibration, any shaking will cause the calibration to deviate.
- Any drastic shaking might cause 'err' shown on the screen, please calibrate again.
- Do not arbitrarily perform calibration operations while it is not necessary.

● Offset

In case of emergency shooting, the camera cannot be leveled and there is no time for sensor calibration, the camera can be adjusted to a horizontal state by offset.

- Turn on the gimbal and the camera level, check the offset of the tilt and yaw axis.
- Enter the menu, select advanced>calibrate>offset, select an axis that is not horizontal, and then turn the dial to adjust the fine adjustment value of the axis until the camera completely keeps level.

camera	>	iFocus	>	gyro		tilt	[0]	tilt	[1]
gimbal	>	inception	>	acc		roll	[0]	roll	[0]
advanced	>	manual pos	>	angle offset	>	pan	[0]	pan	[0]
general	>	calibration	>						

! Notes:

- The offset can only adjust the angle of each axis within the range of about $\pm 5^\circ$, if there is too much offset, the camera cannot be completely leveled.
- Offset is only a temporary solution, after shooting, accelerometer calibration is still needed.
- The parameters of the offset will not be saved and will become invalid after restart.

Language Switch

The Air 2S supports both Chinese and English. After turning on the gimbal, users can switch language in the menu.

camera	>	language	>	English		English	*
gimbal	>	config	>	中文	*	中文	
advanced	>	about					
general	>						

User Configuration Management

The Air 2S can save 3 groups of user data like camera type, motor output, button operations and other parameters, so users can retrieve relevant parameters previously used and avoid trouble of setting parameters each time when changing the camera.

camera	>	language	>	config1	>	save	
gimbal	>	config	>	config2	>	load	
advanced	>	about		config3	>		
general	>			reset			

When configuration data is confusing, users can select "restore configuration" to clear all previous configuration data.

Management

Smartphone and PC Connection

The Air 2S is equipped with BLUETOOTH 5.0 and can be connected with smartphones. Users can set parameters, shot time-lapse video, upgrade firmware and make other operations via the MOZA Master App. With a Type-C USB interface, the Air 2S is able to be connected to a computer. Users can set parameter, upgrade firmware and make other operations via the MOZA Master software.

Download Link: <https://www.gudsen.com>

! Note:

1. The MOZA Master supports iOS, Android, Windows and MacOS
2. Before using the MOZA Master on computer, please install the driver first, otherwise the computer cannot recognize the Air 2S
3. Smart phones cannot directly pair with the Air 2S via Bluetooth, MOZA Master App must be used to connect your phone with the Air 2S

Install the Phone Holder

Install the phone on top of the camera. Operate object tracking through App.

- a. Fix the phone holder to the hot shoe connector on the top of the camera
- b. Place the phone horizontally in the phone holder
- c. Open the App. Enter the object tracking feature. Adjust the phone angle. Make the phone framing as consistent as possible with the camera framing.



In addition to being mounted on the top of the camera for object tracking, the phone holder can also be used to fasten the phone to tripod head for mimic motion control.

Firmware Upgrade

Upgrade via computer:

- a. Turn off the gimbal.
- b. Hold the Menu button and do not release, then press the power button with the other hand until the prompt 'Boot Mode' appears on the screen.
- c. Connect the gimbal to the computer with a USB Type-C cable.
- d. The software will automatically identify the device and load the firmware. Press the 'Upgrade' button and wait for about 30s.

e. Restart the gimbal after the upgrade.

Upgrade via App:

a. Turn off the gimbal.

b. Hold the Menu button and do not release, then press the power button with your other hand until the prompt "Boot Mode" appears on the screen.

c. Start App, press Bluetooth to search for Air 2S device and connect.

d. The App will automatically enter the firmware upgrade interface, please wait for the firmware download to complete, press the 'upgrade' button and wait for about 5 minutes.

e. During the upgrade process, 'upgrading' will be displayed on the gimbal screen, and 'upgrade success' will be displayed on the screen after the upgrade is completed, and then Air 2S can be restarted.



Note: Your gimbal will automatically update to the latest firmware after firmware update process.

Specifications

Air 2S	
Payload Range	0.5kg~4.2kg
Dimension	478*206*184mm(W*D*H)
Tilt Camera Tray Dimension	110 mm
Roll Camera Tray Dimension	100 mm
Pan Mechanical Endpoint Range	360°
Roll Mechanical Endpoint Range	-100°~+200°
Tilt Mechanical Endpoint Range	-190°~+110°
Battery Type	Li-ion 18650MH1-4S1P 4INR19/66
Battery Capacity	3200 mAh
Working Voltage	14.8V
Static Current	150mA
Communication	BT5.0 BLE
	USB
Camera Control Port	Mini USB 5V 1A
Dummy Battery Port	DC2.0mm 7.8V 1A
Accessory Power Supply Port	DC5.5mm 16.8V
TYPE-C Port	Quick-acting charging is available
Temperature	0-50°C

包装清单

使用本产品前，请检查产品包装内是否包含以下所有物品。若有缺失，请联系MOZA或您的代理商。

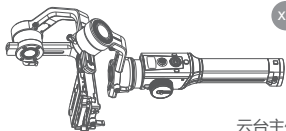

x1

云台主体

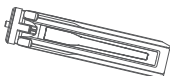

x1

三脚架

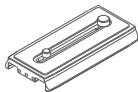

x1

快装系统

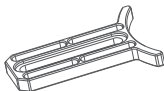

x1

镜头支架

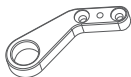

x1

跟焦安装管转接件



x2

M3螺丝



x1

H2内六角扳手



x1

相机拆卸扳手

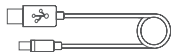

x1

USB-C数据线

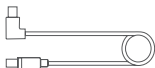

x1

MOZA 相机控制线-Micro



x1

MOZA 相机控制线-Mini



x1

MOZA 相机快门线-Remote



x1

MOZA 相机快门线-Multi

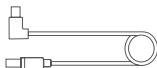

x1

MOZA 相机快门线-Multi/C



x2

跟焦安装管



x1

镜头支架螺丝



x1

便携包



x1

附件收纳包



x1

用户手册

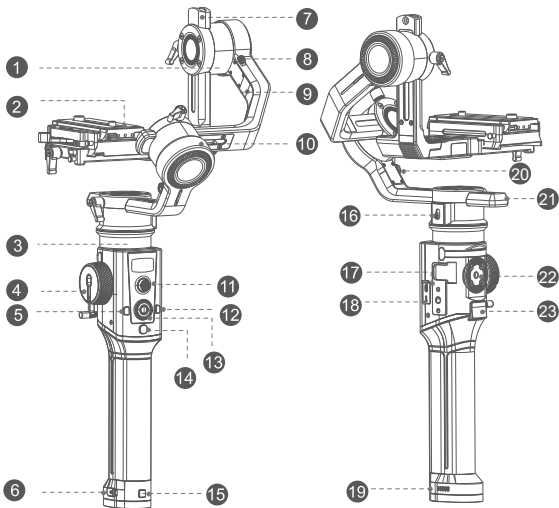

- | | | | |
|-------------|---------|-------------|-------------|
| ① 俯仰电机 | ⑦ 俯仰臂 | ⑬ 拨盘 | ⑲ 电池指示灯 |
| ② 机械记忆快装系统 | ⑧ 俯仰电机锁 | ⑭ 开关机键 | ⑳ 横滚电机锁 |
| ③ 航向电机 | ⑨ 横滚臂 | ⑮ 电池开关键 | ㉑ 航向臂 |
| ④ 手轮 | ⑩ 横滚电机 | ⑯ 航向电机锁 | ㉒ 1/4" 扩展接口 |
| ⑤ M键 | ⑪ 摇杆 | ⑰ 扩展接口 | ㉓ 扳机键 |
| ⑥ Type-C充电口 | ⑫ S键 | ⑱ 调参及固件升级接口 | |

安装Air 2S

三脚架的安装和使用

Air 2S底部带有一个1/4" 螺丝孔和一个3/8" 螺丝孔，使用桌面三脚架时，将三脚架拧入1/4" 的螺丝孔中，再展开三脚架，即可将Air 2S放置在桌面等平整的地方。

如果需要将Air 2S安装到大型三脚架、滑轨等设备上，则可以直接安装在3/8" 的螺丝孔上，拧紧即可。

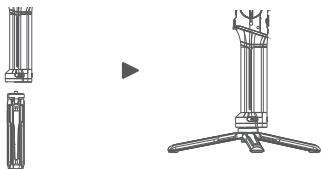

电池的启动和关闭



- 长按电池开关键，待电池指示灯从右至左依次亮起后松开电池开关键，电池启动完成
- 单击电池开关键，然后在三秒内立即再次长按电池开关键，待电池指示灯从左至右依次熄灭后松开电池开关键，电池关闭
- 电池在云台关机状态下，10分钟后会自动关闭，如需启动云台需要先开启电池

⚠ 关机时，建议先长按稳定器开关机键关闭稳定器，然后再按照操作关闭电池。

相机的安装和拆卸

Air 2S所配的快速板，带有一个1/4" 螺丝，一个3/8" 螺丝，根据相机底部的固定螺丝孔，选择合适的螺丝即可。将多余的螺丝拆下，装入附件收纳包中，防止丢失。

Air 2S所配的快速板没有前后方向性要求，无论朝前或朝后滑入都可以正常安装。将相机固定到快速板上时，让镜头略微超出快速板，以便安装镜头支架及跟焦安装管转接支架。

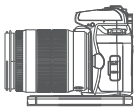

- 固定好相机后，松开锁紧扳手A，将快速板插进快装底座中，快速板没有方向要求，从前方或后方都可以正常安装
- Air 2S的快速系统具有记忆功能，在插入快速板时，请确认安全销1和安全销2均已有效锁止快速板，快速板无法前后移动。然后通过锁紧扳手A锁紧快速板

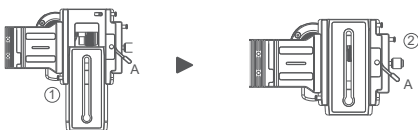

- 拆卸快速板时，如果按住安全销1，则可以将快速板从前面直接抽出

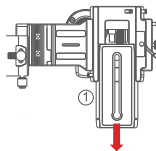

- 如果需要向后取出快速板，则需要先按住安全销1，然后向后滑动快速板，在快速板移动到尽头时，需要按住安全销2，才能将快速板完全取下

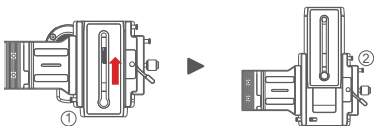

▲ 注意：为达到最佳使用效果，建议您使用镜头支架

相机控制线的安装

Air 2S配有4条相机控制线，全部收纳于附件收纳包中

- MOZA相机控制线-Mini：适用于配备Mini USB接口的相机，如佳能5D3等
- MOZA相机控制线-Micro：适用于使用配备Micro USB接口的相机，如佳能5D4等
- MOZA相机快门线-Remote：适用于配备2.5mm接口的松下相机，如GH3、GH4等
- MOZA相机快门线-Multi：适用于配备Multi接口的相机，如索尼A7sII、A7III等
- MOZA相机快门线-Multi/C：适用于配备Multi接口且支持USB供电的相机，如索尼A7sII、A7III等

连接相机控制线时，先将弯头Mini USB端插入Air 2S的相机控制接口Cam Ctrl，再将另一端插入相机的USB口或控制口即可。相机连接成功后，Air 2S屏幕上会显示相机图标，您可以使用Air 2S来控制相机

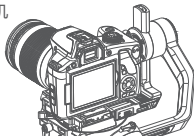

⚠ 注意：

- 不同相机及镜头支持的功能会有差异,详细情况请参考相机控制部分
- 不支持USB协议的相机在连接到Air 2S云台后不会自动显示相机图标，需要手动选择对应的协议类型才能完成相机控制线的安装

跟焦安装管的安装和拆卸

当需要在Air 2S上安装跟焦器时，需要先安装好跟焦安装管。

从附件收纳包中取出跟焦安装管转接支架*1、M3*10螺丝*2、H2内六角扳手*1，将转接支架固定在快装板前面的螺纹孔中，然后将跟焦安装管安装在跟焦安装管转接支架即可。

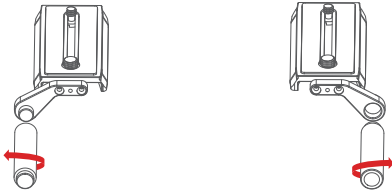

靠左侧安装时，跟焦安装管转接支架的螺柱和跟焦安装管的螺孔配合，逆时针方向锁紧。

靠右侧安装时，跟焦安装管转接支架的螺孔和跟焦安装管的螺柱配合，顺时针方向锁紧。

- ⚠ 注意：1.为防止跟焦器安装管松脱，请按照上图示意的位置关系来安装跟焦安装管转接支架和跟焦安装管。 2.两根跟焦安装管不能装配到一起延长使用。

平衡调节

⚠ 注意：平衡调节可以参考Air 2S的平衡检查功能，按照检查结果的指示来进行调节会更加方便

⚠ 注意：如横滚臂在与航向臂重叠位置被锁止，请先解锁横滚电机，切勿强行拉拽！

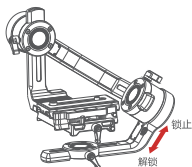

快装板前后调节

- 将相机安装在Air 2S上后，松手查看镜头的指向
- 如果镜头斜向上，则相机位置靠后，松开快装底座锁紧旋钮，将快装底座向前调，直到镜头指向前方
- 如果镜头斜向下，则相机位置靠前，松开快装底座锁紧旋钮，将快装底座向后调，直到镜头指向前方
- 锁紧快装底座锁紧旋钮

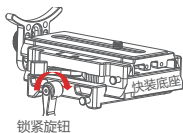

俯仰臂调节

- 将相机转动到镜头朝上，缓慢松手，检查相机朝哪个方向偏转
- 松开俯仰臂调节旋钮1，将俯仰臂2朝相机偏转的反方向调整，直到相机保持镜头向上
- 锁紧俯仰臂调节旋钮1

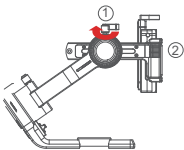

横滚臂调节

- 将横滚电机锁拨到解锁位
- 观察静止时，横滚臂的偏转方向
- 松开横滚臂调节旋钮1，将横滚臂2朝着偏转的反方向调节，直到横滚臂2保持水平
- 锁紧横滚臂调节旋钮1

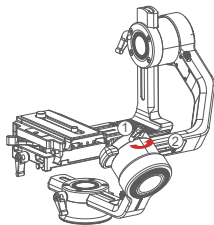

航向臂调节

- 将Air 2S水平侧放，使航向臂保持水平，缓慢松手，检查相机朝哪个方向偏转
- 松开航向臂调节旋钮1，将航向臂2朝着偏转的反方向调节，直到航向臂2保持水平
- 锁紧航向臂调节旋钮1

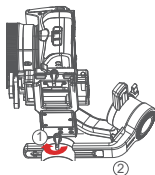

⚠ 注意: 如果没有调节好航向臂的平衡，会导致航向电机发热，跟随过冲等情况，且盗梦空间功能无法正常使用

按键操作及屏幕显示说明





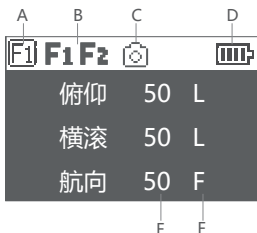

按键定义

按键名称	操作	默认功能	按键自定义						菜单内功能
扳机键	单击	——	无操作	对焦	快门	——	——	——	不变
	双击	归中	无操作	归中	自拍	——	——	——	不变
	三击	自拍	无操作	归中	自拍	——	——	——	不变
	按住	航向-俯仰跟随	无操作	航向-俯仰跟随	全锁定	急速跟随	态极模式	——	不变
电源键	单击	录制/停止	——	——	——	——	——	——	不变
	双击	拍照	——	——	——	——	——	——	不变
	长按	开机/关机	——	——	——	——	——	——	不变
手轮	旋转	航向轴	跟焦器1	跟焦器2	电子跟焦	俯仰轴	横滚轴	——	不变
M键	单击	切换手轮模式	——	——	——	——	——	——	不变
S键	单击	急速跟随开关	——	——	——	——	——	——	不变
	双击	盗梦空间开关	——	——	——	——	——	——	不变
	三击	态极模式开关	——	——	——	——	——	——	不变
	长按	自动调参	——	——	——	——	——	——	不变
摇杆	上下拨动	俯仰转动	俯仰轴	横滚轴	航向轴	——	——	——	不变
	左右拨动	航向转动	俯仰轴	横滚轴	航向轴	——	——	——	不变
拨盘上键	单击	TV	——	——	——	——	——	——	选择条上移
	双击	俯仰跟随开关	——	——	——	——	——	——	——
拨盘下键	单击	AV	——	——	——	——	——	——	选择条下移
	双击	航向跟随开关	——	——	——	——	——	——	——
拨盘左键	单击	ISO	——	——	——	——	——	——	返回
	双击	横滚跟随开关	——	——	——	——	——	——	——
拨盘右键	单击	取景器开关	——	——	——	——	——	——	确认
拨盘中键	单击	进入菜单	——	——	——	——	——	——	不变
	三击	中/英文切换	——	——	——	——	——	——	不变
	长按	休眠/唤醒	——	——	——	——	——	——	不变
拨盘轮	旋转	调节跟随速度	——	——	——	——	——	——	调节选中
组合键	菜单键+电源键	进入升级模式	——	——	——	——	——	——	——

屏幕显示



A: 手轮工作模式

-  手轮控制外接跟焦器1
-  手轮控制外接跟焦器2
-  手轮控制相机的电子跟焦
-  手轮控制俯仰轴转动
-  手轮控制横滚轴转动
-  手轮控制航向轴转动

B: 跟焦器连接状态，接入跟焦器后，显示该图标。没有接入则不显示，最多可接入两个跟焦器

C: 相机连接状态，接入USB控制的相机后，显示该图标，未接入相机或接入非USB控制的相机则不显示

D: 电池电量，每格代表25%的电量，当电量为空时，请及时充电

E: 跟随速度值，0—100，通过旋转拨盘调节，速度越大，跟随越快

F: 跟随状态

L: 锁定，该轴的跟随功能处于关闭状态

F: 跟随，该轴的跟随功能处于开启状态

Q: 极速跟随

菜单说明

L1	L2	L3	L4	L5	值	功能	
相机	选择	快门线			*	设置相机控制类型为通用快门线	
		MCSC-Multi			*	设置相机控制类型为索尼-Multi 接口	
		MCSC-Multi/C			*	设置相机控制类型为索尼-Multi 接口并供电	
		MCSC-Remote			*	设置相机控制类型为松下-Remote 接口	
	M3C-USB			*	设置相机控制类型为 USB 接口		
	参数	ISO			32--106400	设置相机 ISO 参数, 无法调节时显示N/A	
TV				30--1/8000	设置相机快门参数, 无法调节时显示N/A		
AV				F1.2--F22	设置相机光圈参数, 无法调节时显示N/A		
电机	力度	开关			on/off	开启/关闭电机	
			自动调参			调参结果	进行/完成自动调参
		等级	超轻	?/ok			设置电机出力档位为最小
			轻	?/ok			设置电机出力档位为小
			中	?/ok			设置电机出力档位为中
			重	?/ok			设置电机出力档位为大
			超重	?/ok			设置电机出力档位为最大
		自定义	俯仰	0 - 100			设置俯仰电机的出力大小
			横滚	0 - 100			设置横滚电机的出力大小
			航向	0 - 100			设置航向电机的出力大小
	滤波	俯仰		0-100		设置俯仰电机的滤波参数	
		横滚		0-100		设置横滚电机的滤波参数	
		航向		0-100		设置航向电机的滤波参数	
	跟随	开关	俯仰		on/off	开启/关闭俯仰轴跟随功能	
			横滚		on/off	开启/关闭横滚轴跟随功能	
			航向		on/off	开启/关闭航向轴跟随功能	
		速度	俯仰		0-100		设置俯仰电机的跟随速度
			横滚		0-100		设置横滚电机的跟随速度
			航向		0-100		设置航向电机的跟随速度
		死区	俯仰		0-100		设置俯仰电机的跟随启动角度
横滚				0-100		设置横滚电机的跟随启动角度	
航向				0-100		设置航向电机的跟随启动角度	
云台	摇杆	功能	左右	t/r/p		摇杆左右拨动控制俯仰/横滚/航向旋转	
			上下	t/r/p		摇杆上下拨动控制俯仰/横滚/航向旋转	
		灵敏度	左右	0 - 100			摇杆左右拨动的灵敏度
			上下	0 - 100			摇杆上下拨动的灵敏度
		习惯	左右	+/-			摇杆左右拨动正向/反向控制
			上下	+/-			摇杆上下拨动正向/反向控制
	手轮	功能	跟焦器1	*		使用跟焦手轮控制外接跟焦器1	
			跟焦器2	*		使用跟焦手轮控制外接跟焦器2	
			电子跟焦	*		使用跟焦手轮控制相机电子跟焦	
			航向	*		使用跟焦手轮控制航向轴	
			俯仰	*		使用跟焦手轮控制俯仰轴	
			横滚	*		使用跟焦手轮控制横滚轴	
	灵敏度		0-100			手轮控制的灵敏度	
	习惯		+/-			手轮正向/反向控制	
	操作	按住	空		*	按住扳机键不执行任何操作	
航向-俯仰跟随				*	按住扳机键进入航向-俯仰跟随模式		
全锁定				*	按住扳机键进入全锁定模式		
极速跟随				*	按住扳机键进入极速跟随模式		
态极				*	按住扳机键进入态极模式		
单击		空		*	单击扳机键不执行任何操作		
		快门		*	单击扳机键拍摄照片		
		对焦		*	单击扳机键自动对焦一次		

L1	L2	L3	L4	L5	值	功能		
云台	操作	扳机	双击	空	*	双击扳机键不执行任何操作		
				归中	*	双击扳机键云台归中		
		三击	自拍	*	双击扳机键云台旋转 1 80°			
			空	*	三击扳机键不执行任何操作			
拨盘	习惯	归中	*	三击扳机键云台归中				
		自拍	*	三击扳机键云台旋转 1 80°				
高级	自动调参				调参结果	执行自动调参		
	平衡检查				调整建议	相机的平衡状态		
	跟焦器	F1	开关			on/off	开启/关闭跟焦器	
			设定 A 点			? /ok/err	设定跟焦器的 A 点	
			设定 B 点			? /ok/err	设定跟焦器的 B 点	
			清除 AB 点			? /ok/err	清除标定信息	
		F2	跟焦示教			>		进入智能示教模式
			开关				on/off	开启/关闭跟焦器
			设定 A 点				? /ok/err	设定跟焦器的 A 点
			设定 B 点				? /ok/err	设定跟焦器的 B 点
	希区柯克	清除 AB 点				? /ok/err	清除标定信息	
		跟焦示教				>	进入智能示教模式	
	盗梦空间	速度				0-100	设置盗梦空间的转动速度	
	体感控制	开关	俯仰				on/off	开启/关闭俯仰轴的体感控制
			横滚				on/off	开启/关闭横滚轴的体感控制
			航向				on/off	开启/关闭航向轴的体感控制
	物体跟踪	速度				0-100	设置体感控制的速度	
	手动定位	开关	俯仰				on/off	打开/关闭俯仰轴的手动定位
			横滚				on/off	打开/关闭横滚轴的手动定位
			航向				on/off	打开/关闭航向轴的手动定位
标定	陀螺仪					? /ok/err	正在/已经校准陀螺仪	
		加速度计				? /ok/err	正在/已经校准加速度计	
	姿态微调	俯仰				0-100	设置俯仰轴的平衡偏移量	
		横滚				0-100	设置横滚轴的平衡偏移量	
		航向				0-100	设置航向轴的平衡偏移量	
通用	语言	English				*	设置显示语言为英文	
		中文				*	设置显示语言为中文	
	配置	配置 1	保存				? /ok	将目前的参数保存为配置 1
			加载				? /ok	加载 配置 1 所保存的参数
		配置 2	保存				? /ok	将目前的参数保存为配置 2
			加载				? /ok	加载 配置 2 所保存的参数
		配置 3	保存				? /ok	将目前的参数保存为配置 3
			加载				? /ok	加载 配置 3 所保存的参数
还原					? /ok	恢复默认参数设置		
关于						设备名称、蓝牙ID 及固件版本信息		

菜单类型的识别与操作方法：

- 如果当前菜单列表中某项目右侧有 ' * ' 标志，则当前列表为最终选项，点击拨盘右键可以将 ' * ' 移动到选中的项目上，启用该项目
- 如果选中的项目右侧有 ' > ' 标志，则该项目有下级菜单，点击拨盘右键进入下级菜单
- 如果选中的项目右侧有 ' [] ' 标志，内含数字，则转动拨盘可调节该值
- 如果选中的项目右侧有 ' [] ' 标志，内含选项，则点击拨盘右键可以使该 项目在几个选项中切换

注意：

1. 如果选中的项目及其所在的菜单列表中的其它项目右侧均没有标志，则点击右键可以执行该选项一次，执行过程中该项目右侧显示 ' ? ' 执行完成后显示 ' ok ' ，如果执行失败则显示 ' err ' 。
2. 平衡检查、自动调参、关于的界面为特殊界面，上述显示规则不适用。
3. 滤波参数：电机出现高频振动时适当调小，电机出现低频振动时适当调大。
4. 手动定位功能优先级低于跟随功能，开启某个轴的手动定位后，需要关闭该轴的跟随，才能正常使用手动定位功能。

功能说明

相机控制 (* 请将镜头对焦开关设置为MF)

品牌	型号	相机选择	线材	快门	录制	ISO	TV	AV	自动对焦	电子聚焦	供电		
CANON	EOS R	M3C-USB	M3C-Micro+ Micro to Type-C Adapter (选配)	√	√	√	√	√	√	√	—		
	EOS RP			√	√	√	√	√	√	√	—		
	EOS 6D Mark II			*	√	√	√	√	√	√	√	—	
	EOS 6D		* √	√	√	√	√	√	√	√	—		
	EOS 60D		* √	√	√	√	√	√	√	√	—		
	EOS 70D		* √	√	√	√	√	√	√	√	—		
	EOS 77D		* √	√	√	√	√	√	√	√	—		
	EOS 80D		* √	√	√	√	√	√	√	√	—		
	EOS SD2		* √	√	√	√	√	√	√	√	—		
	EOS SD3		* √	√	√	√	√	√	√	√	—		
	EOS 800D		* √	—	√	√	√	√	√	√	—		
	EOS 5D Mark IV		* √	√	√	√	√	√	√	√	—		
	EOS 200D II		* √	√	√	√	√	√	√	√	—		
	EOS M50		* √	√	√	√	√	√	√	√	—		
	EOS M5		MCSC-C1	C1 Shutter Cable (选配)	√	—	—	—	—	—	—	√	
SONY	Alpha 7S	M3C-USB	M3C-Micro	—	√	√	√	√	√	—	√		
	Alpha 7R			—	√	√	√	√	√	—	√		
	Alpha 6300			—	√	√	√	√	√	—	√		
	Alpha 6400			—	√	√	√	√	√	—	√		
	Alpha 6500			—	√	√	√	√	√	—	√		
	Alpha 7S II			—	√	√	√	√	√	—	√		
	Alpha 7R II			—	√	√	√	√	√	—	√		
	Alpha 7 III			—	√	√	√	√	√	—	√		
	Alpha 7R III			—	√	√	√	√	√	—	√		
	DSC-RX100M3			—	√	√	√	√	√	—	√		
	DSC-RX100M4			—	√	√	√	√	√	—	√		
	DSC-RX100M5			—	√	√	√	√	√	—	√		
	Alpha 7S			MCSC-Multi	MCSC-Multi	√	√	—	—	—	√	—	√
	Alpha 7R			MCSC-Multi/C	MCSC-Multi/C	√	√	—	—	—	√	—	√
	Alpha 6300					√	√	—	—	—	√	—	√
Alpha 6400	√	√	—			—	—	√	—	√			
Alpha 6500	√	√	—			—	—	√	—	√			
Alpha 7S II	√	√	—			—	—	√	—	√			
Alpha 7R II	√	√	—			—	—	√	—	√			
Alpha 7 III	√	√	—			—	—	√	—	√			
Alpha 7R III	√	√	—			—	—	√	—	√			
DSC-RX100M3	√	√	—			—	—	√	—	√			
DSC-RX100M4	√	√	—			—	—	√	—	√			
DSC-RX100M5	√	√	—			—	—	√	—	√			
Panasonic	DMC-G7KGK	MCSC-Remote	MCSC-Remote			√	√	—	—	—	√	—	—
	DMC-G85GK					√	√	—	—	—	√	—	—
	DMC-GH3					√	√	—	—	—	√	—	—
	Lumix GH4					√	√	—	—	—	√	—	—
	DC-S1GK-K			√	√	—	—	—	√	—	—		
Nikon	Lumix GH5	M3C-USB	M3C-Micro+ Micro to Type-C Adapter (选配)	√	√	√	√	√	√	√	—		
	DC-GH5SGK-K			√	√	√	√	√	√	√	—		
	26			√	√	√	√	√	√	√	—		
FUJIFILM	27	M3C-USB	M3C-Micro+ Micro to Type-C Adapter (选配)	√	√	√	√	√	√	√	—		
	D850			√	√	√	√	√	√	√	—		
	X-T2		M3C-Micro	√	√	√	√	√	√	√	—		
	X-T3			√	√	—	—	—	√	—	—		
	X-T20			√	√	—	—	—	√	—	—		
X-T30	√	√	—	—	—	√	—	—					

注意：最新相机控制列表请参考官方网站提供的相机控制文档。

操作步骤：

- 长按拨盘中键进入菜单，选择 '相机'，参考相机支持列表选择使用的相机型号

- 参考相机支持列表连接相机控制线。

相机控制线一端为Mini-USB接口，连接在Air 2S的相机控制口，另一端连接在相机对应的控制接口即可。

- 选择好相机类型并连接好相机控制线后，可通过单击电源键控制相机录制，双击电源键控制相机拍照。

注意：

1. Micro USB 3.0接口的相机，如尼康D850，可使用M3C-Micro线插入Micro USB 2.0部分即可正常控制



2. 插入相机控制线后，如果相机屏幕上有提示信息，请按照相机屏幕上的提示来操作相机，否则相机控制功能可能无法正常使用

- 录制/停止：单击电源键
- 拍摄照片：双击电源键
- 调节快门：拨盘上键 (TV)
- 调节光圈：拨盘下键 (AV)
- 调节ISO：拨盘左键 (ISO)

调节相机参数时，先按下对应的键，屏幕上会显示对应的值，然后转动拨盘调整该值，调整完成后，再次按下对应的按键，即可关闭相机的参数调整。

- 打开/关闭实时预览：按下拨盘右键，即可打开或者关闭相机的实时预览功能，打开实时预览后，相机屏幕会亮起，显示取景内容

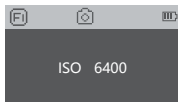
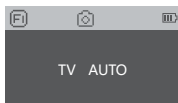

注意：

1. 只有唤出相机的参数设置后，转动拨盘才能调节相机对应的参数，默认状态下转动拨盘会调节跟随速度。
2. 部分相机（如索尼A7S2）带有传感器，如果取景器前方被遮挡，会自动关闭相机屏幕，切换到取景器观看预览，请在相机设置中将预览设置为显示屏即可

电机出力

Air 2S的有效负载为4200g，在负载不同的重量时，需要调节电机的出力大小，才能达到最佳的稳定效果。Air 2S有以下3种调节电机出力的方法：

- 自动调参的操作方法：
 - a. 安装好相机并调节好平衡；
 - b. 打开所有的电机锁；
 - c. 稳定器开机，长按Fn键，或进入菜单选择'高级'>'自动调参'；
 - e. 自动调参的过程中，稳定器各个电机会自行转动，寻找最合适的出力值。等待约5秒，稳定器停止抖动，调参完成。

相机 >	电机 >	开关	自动调参	自动调参
云台 >	跟随 >	力度 >	等级 >	等级 >
高级 >	操作 >	滤波 >	自定义 >	自定义 >
通用 >				

- 设定出力档位：

稳定器出厂时，预置了5组电机出力值，适合不同重量级别的相机，方便用户快速使用。进入菜单，选择'云台'>'电机'>'出力'>'等级'即可。
- 自定义各个电机的出力值：

如果需要更加精确的控制电机出力，用户可通过自定义来修改每个电机的出力值，调节范围为0--100。进入菜单，选择'云台'>'电机'>'出力'>'自定义'即可。





⚠ 注意：

1. 在比较极限的相机镜头组合下，自动调参功能可能无法准确计算出合适的出力值，请根据情况手动调节电机出力。
2. 电机出力太低，会导致拍摄画面不够稳定；电机出力太高，会导致稳定器高频震动。
3. 当电机出力在临界值时，稳定器在正置状态下不震动，但在前倾或倒置状态下会震动，请适度降低电机出力即可。

跟随模式、态极模式、极速跟随

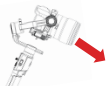
Air 2S支持独立控制各轴的跟随开关，开启跟随功能后，稳定器会根据用户的动作，来控制相机跟随转动。

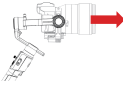
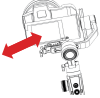
用户可通过拨盘按键直接开启/关闭各轴的跟随及转动拨盘调节跟随速度，也可以在菜单内完成调节。

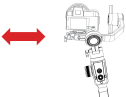
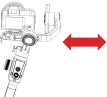
跟随开关	对比示例一	对比示例二
开启俯仰跟随		
关闭俯仰跟随		
开启横滚跟随		
关闭横滚跟随		

⚠ 注意：

1. Air 2S出厂默认开启航向跟随。
2. 除了独立控制各轴的跟随开关，也可以通过扳机键来迅速进入常用的跟随模式
3. 横滚跟随的角度为30°，如需更大的横滚跟随角度，请三击Fn键，进入态极模式，即可三轴全域跟随
4. 如果需要更快的航向跟随速度，可单击Fn键，开启极速跟随模式。极速跟随模式仅支持航向轴

手动定位

手动定位可快速调整相机拍摄的方向。开启手动定位后，用手直接掰动相机朝向，相机会停留在最终的方向，不会自动回到稳定位置，可用于快速调节相机的拍摄方向

Air 2S默认开启俯仰轴和航向轴的手动定位功能，横滚轴的手动定位可在菜单内开启。

相机 >	平衡检查	俯仰 [off]	俯仰 [on]
云台 >	跟焦器 >	横滚 [off]	横滚 [off]
高级 >	盗梦空间 >	航向 [on]	航向 [on]
通用 >	手动定位 >		

⚠注意：

跟随功能的优先级高于手动定位，当某个轴的跟随功能打开后，手动定位功能则无法使用，关闭跟随后，手动定位功能才能正常使用。

按键自定义

按键自定义可以按照用户的使用习惯，来手动指定各个按键的功能、灵敏度及操作方向。

例：

上下拨动摇杆默认控制俯仰轴转动，可通过自定义，来控制横滚轴或航向轴转动；

左右拨动摇杆默认控制俯航向转动，可通过自定义，来控制俯仰轴或航向轴转动；

相机 >	电机 >	摇杆 >	功能 >	左右 [p]
云台 >	跟瞄 >	手轮 >	灵敏度 >	上下 [U]
高级 >	操作 >	扳机 >	习惯 >	
通用 >		拨盘 >		

按键的灵敏度越高，控制越敏感、快速，将‘习惯’改为-，则操作方向与原来相反。更多的按键自定义，请参考‘菜单说明’。

盗梦空间

盗梦空间功能可控制相机水平转动，用于拍摄颠倒、旋转的画面。主界面下，双击Fn键，即可进入盗梦空间功能。进入盗梦空间功能后，俯仰电机控制相机转动到镜头朝上，自动开启各轴的跟随。

盗梦空间的按键定义：

- 向左或向右拨动摇杆：云台向左或向右转动，松开摇杆或到达指定角度后停止转动

- 转动拨盘：调节转动速度
- 单击拨盘左键：自动向左旋转，如果正在自动旋转，则停止旋转
- 单击拨盘右键：自动向右旋转，如果正在自动旋转，则停止旋转
- 单击拨盘上/下键：选择转动的角度
- 常规：一直旋转不会自动停止
- 180：从开始转的位置起，转动180°后自动停止转动
- 360：从开始转的位置起，转动360°后自动停止转动



盗梦空间功能下，双击Fn键即可退出盗梦空间。

平衡检查

平衡检查能够自动检查俯仰及横滚轴的平衡调节状况，并指导用户进行正确的调节。

- 给Air 2S安装好三脚架，开机后放置在水平的桌面上；
- 进入菜单，选择高级>平衡检查，云台开始检查平衡调节的情况；



- 平衡检查完成后，屏幕上会提示各轴的平衡状况，如需调整，也会提示调整方向；
- 按照提示信息调整后，可重新检查，直到平衡良好。

⚠注意：

- 平衡检查只能检查俯仰轴和横滚轴，无法检查航向轴平衡状态，请手动检查航向轴平衡状态。；使用平衡检查时，务必确认电机锁已经解除；
- 平衡检查完成后，云台会自动关闭电机，以便于调节平衡；调节完平衡后，请长按菜单键以唤醒电机。

传感器校准

● 陀螺仪校准

当稳定器开机后，静置约5分钟，如果出现明显的漂移现象，就需要进行陀螺仪校准。校准陀螺仪的步骤为：

- 稳定器开机（长按电源键）。
- 关闭电机（长按菜单键或进入菜单，选择云台>电机>开关，设置为‘off’）。
- 将Air 2S放置在水平的桌面上，使云台完全水平，保持稳定器处于静止状态，不要晃动稳定器或歪斜放置稳定器。
- 进入菜单，选择高级>标定>陀螺仪，然后按下拨盘右键，等待约5s，直到‘?’变为‘ok’即可。

相机 >	跟焦器 >	陀螺仪	陀螺仪 ok
云台 >	盗梦空间 >	加速度计	加速度计
高级 >	手动定位 >	姿态微调 >	姿态微调 >
通用 >	标定 >		

● 加速度计校准

当稳定器开机后，无明显漂移，但相机不水平，就需要进行加速度计校准。校准加速度计的步骤为：

- 稳定器开机（长按电源键）
- 关闭电机（长按菜单键或进入菜单，选择云台>电机>开关，设置为‘off’）
- 将Air 2S放置在水平的桌面上，使云台完全水平 保持稳定器处于静止状态，不要晃动稳定器或歪斜放置稳定器（建议安装好相机，以相机的水平仪为参考）
- 进入菜单，选择高级>标定>加速度计，然后按下拨盘右键，等待约5s，直到‘?’变为‘ok’即可。

相机 >	跟焦器 >	陀螺仪	陀螺仪
云台 >	盗梦空间 >	加速度计	加速度计 ok
高级 >	手动定位 >	姿态微调 >	姿态微调 >
通用 >	标定 >		

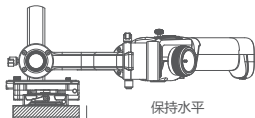

⚠ 注意：

- 校准过程中请使云台保持静止状态，任何的晃动，都会导致校准出现偏差；
- 校准过程中如果晃动过大，屏幕上会提示‘err’，请重新校准；
- 非必要情况时，请不要随意进行校准操作。

● 姿态微调

在紧急的拍摄作业情况下，如果Air 2S不能保持相机水平，又来不及进行传感器校准，可以通过平衡微调，来将相机调节到水平状态。

- 将稳定器开机，然后打开相机的水平仪，观察俯仰轴和航向轴的偏移情况；
- 进入菜单，选择高级>标定>姿态微调，将光标移动到不水平的轴上，然后转动拨盘，调节该轴的微调值，直到相机完全水平。

相机	>	跟焦器	>	陀螺仪		俯仰	[0]	俯仰	[1]
云台	>	盗梦空间	>	加速度计		横滚	[0]	横滚	[0]
高级	>	手动定位	>	姿态微调	>	航向	[0]	航向	[0]
通用	>	标定	>						

⚠注意：

- 平衡微调只能在约 $\pm 5^\circ$ 的范围内来调节各轴的角度，偏差太多的情况下，无法完全调平相机；
- 平衡微调只是临时性的解决办法，在完成拍摄后，还是需要进行加速度计校准；
- 平衡微调的参数不会保存，重启后会失效。

切换显示语言

Air 2S支持中文、英文两种语言，用户可根据自身需求，来设置显示语言。

相机	>	语言	>	English		English	*
云台	>	配置	>	中文	*	中文	
高级	>	关于					
通用	>						

用户配置管理

Air 2S可以保存三组用户的相机类型、电机出力、按键操作习惯等参数，方便用户在使用不同的相机时快速调用，避免每次更换相机后，都要重新调节各个参数的麻烦。

相机	>	语言	>	配置1	>	保存	
云台	>	配置	>	配置2	>	加载	
高级	>	关于		配置3	>		
通用	>			还原			

当配置数据比较混乱时，可选择‘还原’来清除所有用户配置数据。

扩展使用

连接智能手机或电脑

Air 2S内置BLUETOOTH 5.0 BLE蓝牙模块，可与智能手机连接，配合MOZA Master APP，能够进行参数调节、延时摄影拍摄、固件升级等操作。Air 2S配备了一个Type-C USB接口，可连接电脑，配合MOZA Master软件，能够进行参数调节、固件升级等操作。

下载地址：<https://www.gudsen.com>

▲注意：

1. MOZA Master支持的系统为iOS、Android、Windows、MacOS
2. 在电脑上使用MOZA Master软件时，请先安装好驱动，否则电脑无法识别Air 2S
3. 智能手机无法直接与Air 2S进行蓝牙配对连接，必须使用MOZA Master APP才能正常配对连接。

安装手机支架

将手机安装在相机上方，通过APP可实现目标跟踪。

- a. 将手机支架固定在相机顶部的热靴接口上；
- b. 将手机横向装入手机夹；
- c. 打开APP，进入目标跟踪功能，调节手机角度，使取景内容尽量与相机一致。

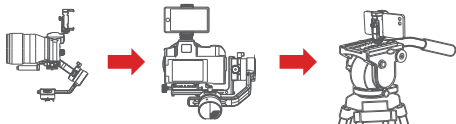

除安装在相机顶部用于目标跟踪外，也可通过手机支架将手机固定于液压云台上，以便使用体感控制功能。

固件升级

如果您使用电脑升级固件，请按以下步骤操作：

- a. 将Air 2S关机
- b. 按住菜单键，不要松开，然后单击电源键，屏幕上会显示 'Boot Mode'，即进入固件升级状态
- c. 将Air 2S通过USB-C数据线连接到电脑上，启动升级软件，在设备列表中选择该Air 2S
- d. 升级软件会自动进入固件升级界面，等待固件下载完成后，点击 '升级' 按钮，等待约30秒
- e. 升级过程中，Air 2S屏幕会显示 'Upgrading'，升级完成后，屏幕会显示 'Upgrade Success'，然后重启Air 2S即可

如果您使用APP升级固件，请按以下步骤操作：

- a. 将Air 2S关机
- b. 按住菜单键，不要松开，然后单击电源键，屏幕上会显示 'Boot Mode'，即进入固件升级状态
- c. 启动APP，点击 '连接' 按钮搜索并连接Air 2S设备
- d. APP会自动进入固件升级界面，等待固件下载完成后，点击 '升级' 按钮，等待约5分钟
- e. 升级过程中，Air 2S屏幕会显示 'Upgrading'，升级完成后，屏幕会显示 'Upgrade Success'，然后重启Air 2S即可

规格参数

Air 2S	
载重	0.5kg~4.2kg
尺寸	478*206*184mm(W*D*H)
俯仰包络尺寸	110 mm
横滚包络尺寸	100 mm
航向轴机械限位范围	360°无限位
横滚轴机械限位范围	-100°~+200°
俯仰轴机械限位范围	-190°到+110°
电池类型	Li-ion 18650MH1-4S1P 41NR19/66
电池容量	3200 mAh
工作电压	14.8V
静态电流	150mA
通信方式	BT5.0 BLE
	USB
相机控制接口	Mini USB 5V 1A
假电池供电接口	DC2.0mm 7.8V 1A
附件供电接口	DC5.5mm 16.8V
TYPE-C充电接口	支持快充
工作温度	0--50℃

产品保修卡

用户资料

产品型号	MOZA Air 2S
购买日期	
姓 名	
电 话	
地 址	

经销商信息（签章）

产品保修条例

保修期

自购机日起，云台主体保修12个月；云台电机、电池保修3个月。设备外壳、说明书、USB线材、包装等不在“一年免费保修服务”范围内，您可以选择有偿服务。

七日内免费退货

自购机日起7日内，根据国家最新三包规定，您可以选择退货（按票面金额一次性退清货款）、换货（更换同型号同规格的产品）或修理。

八至十五日免费换货或修理

自购机日起第8日至第15日内，主机出现性能故障，并经特约维修中心检测，确认非人为损坏的本身质量问题，您可以选择换货（更换同型号、同规格产品）或修理；但是更换的范围，只限于产品主机，其他配件无质量问题，不能更换；购买者在以下条件下不享受免费保修服务，您可以选择有偿服务。

1. 超过三包有效期的；
2. 无三包凭证及有效发货票的，但能够证明该产品在三包有效期内的除外；
3. 包修凭证上的型号与修理产品型号不符或者涂改的；
4. 非本公司特约维修人员拆动造成损坏的；
5. 因不可抗力造成损坏的；
6. 未按产品使用说明书要求使用、维护、保养而造成损坏的。



Follow us
魔爪社交媒体



MOZA WeChat
魔爪微信公众号

GUDSEN

INVENTED FOR VIDEO

Shenzhen Gudsen Technology Co., Ltd

Web: www.gudsen.com