

SAMSUNG

USER MANUAL

SM-R190

English. 06/2021. Rev.1.1

www.samsung.com

Table of Contents

Basics

- 3 Read me first
- 6 About the Galaxy Buds Pro
- 7 Device layout and functions
- 9 Attaching an ear tip to the earbud
- 10 Charging the battery
- 15 Battery indicator lights identification

Appendix

- 38 Troubleshooting
- 41 Managing the Galaxy Buds Pro
- 43 Restarting the earbuds
- 43 Coupling the earbuds
- 43 Removing the battery

Using the earbuds

- 17 Connecting the earbuds to a mobile device
- 22 Wearing the earbuds
- 23 Using the earbud by touch
- 26 Using the noise controls mode
- 28 Using Bixby
- 29 Listening to music
- 30 Using the equaliser
- 31 Using call features

Galaxy Wearable App

- 32 Introduction
- 33 Connecting and disconnecting the earbuds
- 34 Viewing Galaxy Buds Pro status and customising settings

Basics

Read me first

Please read this manual before using this device to ensure safe and proper use.

- Descriptions are based on the device's default settings.
- Some content may differ from your device depending on the region, model specifications, or device's software. Images may differ in appearance from the actual product. Content is subject to change without prior notice.
- Before using other mobile devices, make sure they are compatible with the device. Visit the Samsung website to see the specifications of compatible mobile devices.
- Modifying the device's operating system or installing software from unofficial sources may result in device malfunctions and data corruption or loss. These actions are violations of your Samsung licence agreement and will void your warranty.
- Some functions may not work as described in this manual depending on the maker and model of the mobile device you connect to the device.
- This product includes certain free/open source software. The licence information of the open source software used in this product can be found at opensource.samsung.com.

Maintaining water resistance

The earbuds support water-resistance but the earbuds may be damaged if used in conditions inconsistent with the IPX7 standard. Follow these instructions carefully, as failure to do so may result in damage to your devices. The charging case does not support water-resistance.

- Do not immerse the devices in fresh water deeper than 1 m or keep them submerged for more than 30 minutes.
- Do not expose the devices to water moving with force or running water.
- Do not wear your devices while swimming, playing water sports, taking a shower, or while visiting spa or sauna facilities.
- Do not put the devices into a washing machine or drying machine.

- If the devices are exposed to fresh water, dry them thoroughly by wiping them with a clean, soft cloth and shaking them to remove the water from the devices. Do not expose or immerse the devices to other liquids, such as salt water, swimming pool water, soapy water, oil, perfume, sunscreen, hand cleaner, chemical products such as cosmetics, ionised water, alcoholic beverage, or acid liquids. If the devices are exposed or immersed in any of the liquids above, rinse them with fresh water in a bowl, and dry them thoroughly by wiping them with a clean, soft cloth and shaking them to remove the water from the devices. If you do not follow these instructions, the water can enter the devices' joints and affect the devices' speakers feature, other functionality, and their appearance.
- **It is not recommended to use the devices in water.**
- **Your devices have been tested in a controlled environment and certified to be water-resistant in specific situations (meets requirements of classification IPX7 as described by the international standard IEC 60529-Degrees of Protection provided by Enclosures [IP Code]; test conditions: room temperature, fresh water, 1 metre, 30 minutes).**

Precautions for using the earbuds

- Excessive exposure to loud sounds can cause hearing damage.
- Exposure to loud sounds while walking may distract your attention and cause an accident.
- Always turn the volume down before using the earbuds and use only the minimum volume setting necessary to hear your conversation or music.
- Prolonged skin contact with foreign materials on the earbuds may cause irritation. Make sure the earbuds are clean and dry before wearing them.
- In dry environments, static electricity can build up in the earbuds. Avoid using earbuds in dry environments or touch a metal object to discharge static electricity before using the earbuds.
- Do not use earbuds while driving or riding. Doing so may distract your attention and cause an accident, or may be illegal depending on your region.
- Although the Galaxy Buds Pro comply with international safety standards, inserting the earbuds forcefully or wearing them for a long time may cause pain or skin irritation.
- If you experience any skin irritation while you are wearing the earbuds, stop wearing them immediately and consult a specialist.

- Do not clean the earbuds with compressed air or use ultrasonic waves or external heat sources if dust, sweat, ink, oil, or chemicals (cosmetics, sunscreen, antibacterial spray, hand sanitiser, detergent, insecticide, etc.) come into contact with the earbuds and charging case. Discoloration or corrosion may cause damage to the Galaxy Buds Pro.
- Wash the ear tips with clean water and dry them thoroughly after use, and wipe the earbuds with a soft, dry cloth if they are contaminated.

Instructional icons



Warning: situations that could cause injury to yourself or others



Caution: situations that could cause damage to your device or other equipment



Notice: notes, usage tips, or additional information

About the Galaxy Buds Pro

Galaxy Buds Pro are wireless earbuds which allow you to listen to music or answer incoming calls after connecting them to your mobile device even while doing other activities, such as working out.

 Do not wear the earbuds in high-traffic areas, such as roads or crosswalks. Doing so may result in accidents due to slowed reaction times.



Device layout and functions

Package contents

Refer to the quick start guide for package contents.

- 📄 • The items supplied with the Galaxy Buds Pro, any available accessories, and their images may vary depending on the region or service provider.
- The supplied items are designed only for the Galaxy Buds Pro and may not be compatible with other devices.
- Appearances and specifications are subject to change without prior notice.
- You can purchase additional accessories from the Samsung website. Make sure they are compatible with the Galaxy Buds Pro before purchase.
- Use only Samsung-approved accessories. Using unapproved accessories may cause the performance problems and malfunctions that are not covered by the warranty.
- Availability of all accessories is subject to change depending entirely on manufacturing companies. For more information about available accessories, refer to the Samsung website.

Device layout

Earbud

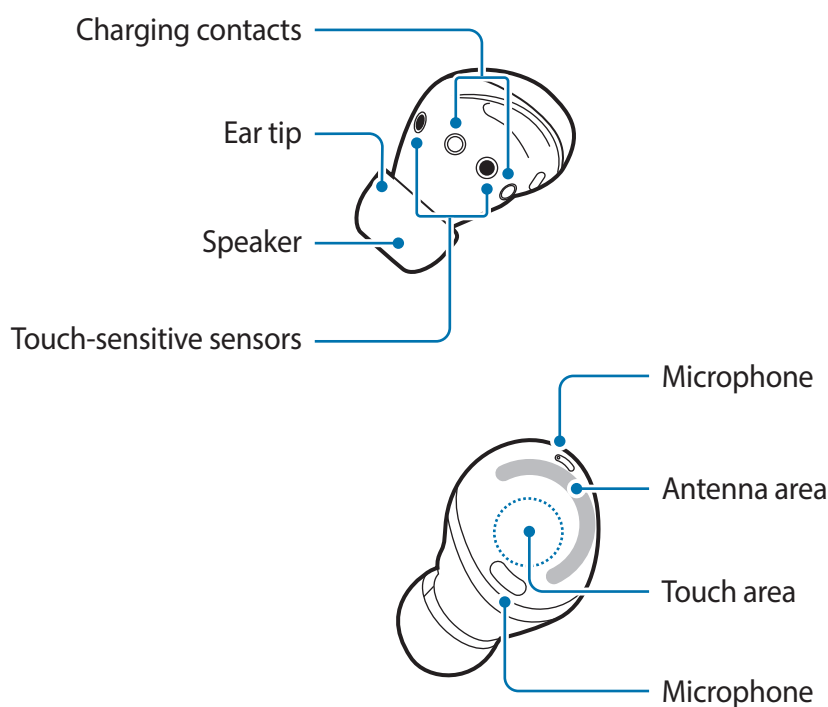

- ❗ If you use the earbuds when they are broken, there may be a risk of injury. Use the earbuds only after they have been repaired at a Samsung Service Centre.
- 👉 If foreign materials are placed on the touch-sensitive sensor, they may cause the sensor to malfunction. Before wearing the earbuds, clean the sensor first.

Charging case

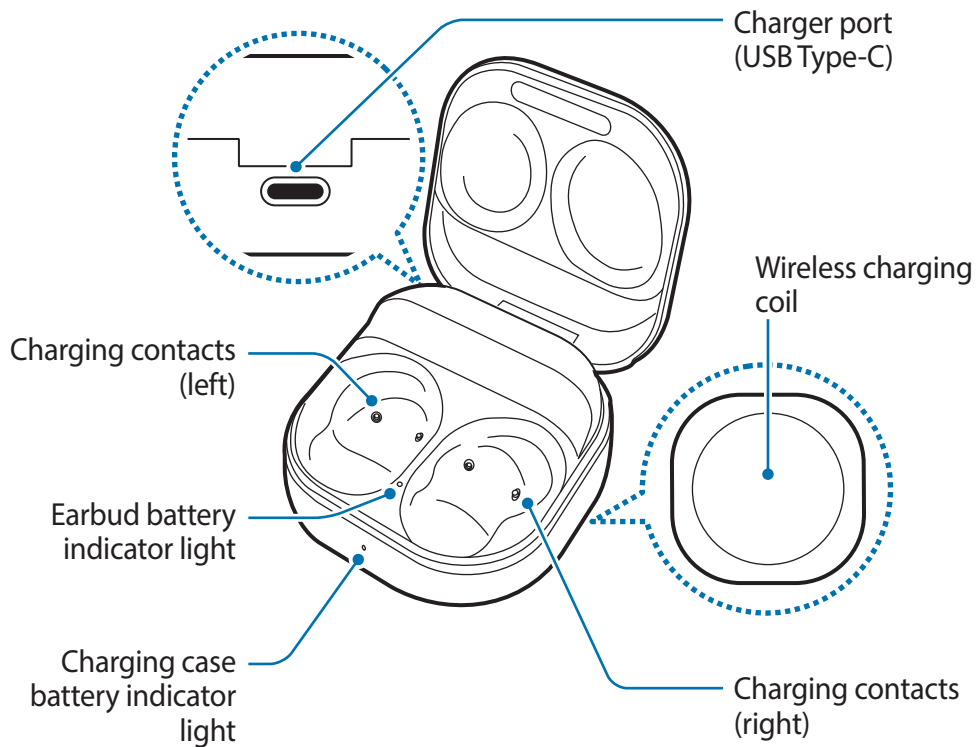

- 👉 If there is sweat or liquid on the charging contacts, corrosion may occur on the Galaxy Buds Pro. When there is sweat or liquid on the charging contacts or earbuds, clean them before inserting the earbuds in the charging case.

Attaching an ear tip to the earbud

- ⚠ • Do not put the earbuds in your ears without ear tips. Doing so may hurt your ears.
- Do not pull the ear tip excessively when you attach or detach it. The ear tip may tear.
- Do not press the ear tip excessively or twist it. The ear tip may be damaged.

- 1 Select the ear tip that fits your ear.
- 2 Align the latch at the bottom of the earbud and groove of the ear tip and cover the latch with the ear tip.

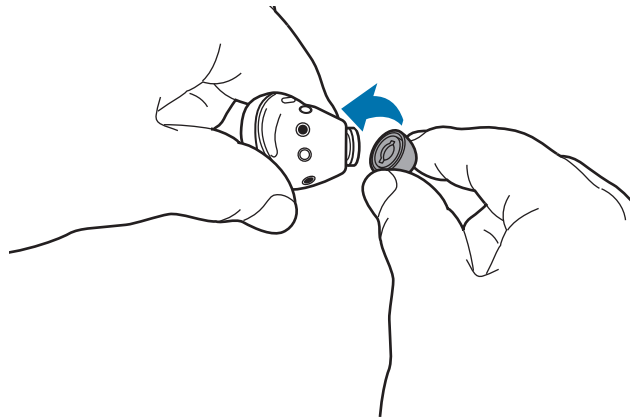



- 3 Follow the same procedure for the opposite earbud.

Charging the battery

Wired charging

Fully charge the battery before using the earbuds for the first time or when they have been unused for extended periods. The earbuds will start to work while charging. When you charge the battery for the first time or when the battery is completely discharged, it needs at least 10 minutes to start to work.

The charging case, which has a built-in battery, is charged along with the earbuds that are in the charging case when connected to the charger.

-  Use only Samsung-approved battery, charger, and cable specifically designed for your device. Incompatible battery, charger, and cable can cause serious injuries or damage to your device.
- 
 - Connecting the charger improperly may cause serious damage to the charging case. Any damage caused by misuse is not covered by the warranty.
 - Use only USB Type-C cable supplied with the Galaxy Buds Pro. The charging case may be damaged if you use Micro USB cable.
- 
 - Chargers are sold separately.
 - To save energy, unplug the charger when not in use. The charger does not have a power switch, so you must unplug the charger from the electric socket when not in use to avoid wasting power.
 - You cannot use your earbuds' wireless features while charging the earbuds' batteries.
 - Keep the charging case closed while you store or charge the earbuds, or when you charge the charging case.
 - If you touch the charging contacts while charging the charging case, it may affect charging.
 - If there is sweat or liquid on the charging contacts, corrosion may occur on the Galaxy Buds Pro. When there is sweat or liquid on the charging contacts or earbuds, clean them before inserting the earbuds in the charging case.
 - When you insert your earbuds in the charging case, the charging will start automatically, and it will stop automatically if earbuds are fully charged.
 - It will likely not have a huge impact on the life of your Galaxy Buds Pro even if you do not remove your earbuds from the charging case after the earbuds are fully charged.
 - If you will not be using your Galaxy Buds Pro for a long time, store them after they are charged.

- 1 Open the charging case.
- 2 Check the direction of each earbud and correctly insert them into their corresponding slots in the charging case.

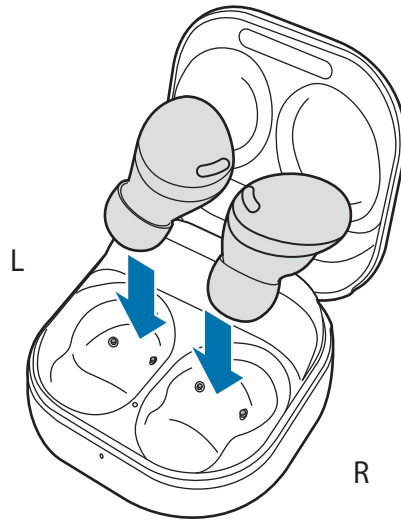

- 3 Close the charging case.

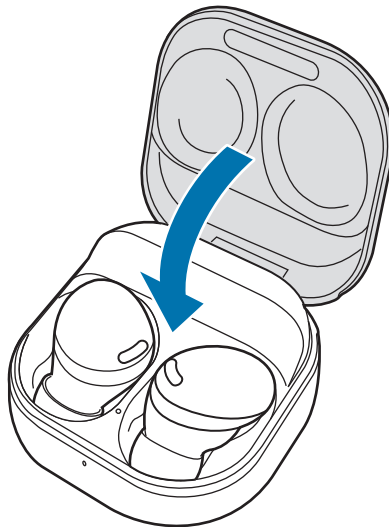

- 4 Connect the USB cable to the charger and then plug the USB cable into the charger port.

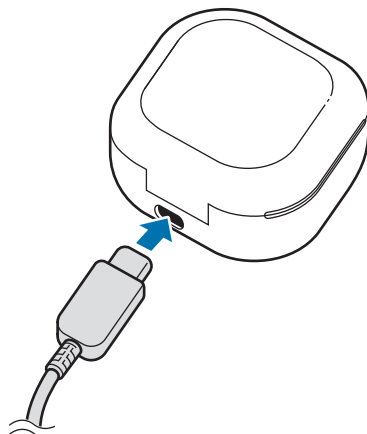

5 Plug the charger into an electric socket.

The batteries of the earbuds and the charging case are charged simultaneously.

6 After fully charging, disconnect the charging case from the charger. First disconnect the USB cable from the charging case and then unplug the charger from the electric socket.

Reducing the battery consumption

When you are not using the earbuds, store them in the charged charging case. The touch-sensitive sensor will continue to work while wearing the earbuds and reduce the usage time.

Battery charging tips and precautions

- If there is sweat or liquid on the charging contacts, corrosion may occur on the Galaxy Buds Pro. When there is sweat or liquid on the charging contacts or earbuds, clean them before inserting the earbuds in the charging case.
- Using a power source other than the charger, such as a computer, may result in a slower charging speed due to a lower electric current.
- While charging, the Galaxy Buds Pro and the charger may heat up. This is normal and should not affect the Galaxy Buds Pro's lifespan or performance. If the battery gets hotter than usual, the charger may stop charging.
- If you charge the Galaxy Buds Pro while the charger port is wet, the Galaxy Buds Pro may be damaged. Thoroughly dry the charger port before charging the Galaxy Buds Pro.
- If the Galaxy Buds Pro are not charging properly, take the Galaxy Buds Pro and the charger to a Samsung Service Centre.
- Avoid bending the USB cable. Doing so may damage or reduce the lifespan of the USB cable. Never use a damaged USB cable.

Wireless charging

The charging case has a built-in wireless charging coil. You can charge the battery by using a wireless charger (sold separately) or another device that functions as a wireless charger.

- 1 Open the charging case.
- 2 Check the direction of each earbud and correctly insert them into their corresponding slots in the charging case.
- 3 Close the charging case.
- 4 Place the centre of the charging case's back on the centre of the wireless charger.

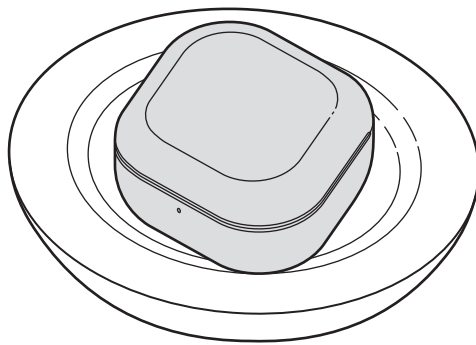

- 5 After fully charging, disconnect the charging case from the wireless charger.

Precautions for wireless charging

Do not place the charging case on the wireless charger when conductive materials, such as metal objects and magnets, are placed between the charging case and the wireless charger.

The Galaxy Buds Pro may not charge properly or may overheat, or the charging case may be damaged.

-  Use Samsung-approved wireless chargers. If you use other wireless chargers, the battery may not charge properly.

Charging via Wireless power sharing

- 1 Open the charging case.
- 2 Check the direction of each earbud and correctly insert them into their corresponding slots in the charging case.
- 3 Close the charging case.

- 4 Turn on the Wireless power sharing feature on the device that functions as a wireless charger and place the centre of the charging case's back on the device that functions as a wireless charger.

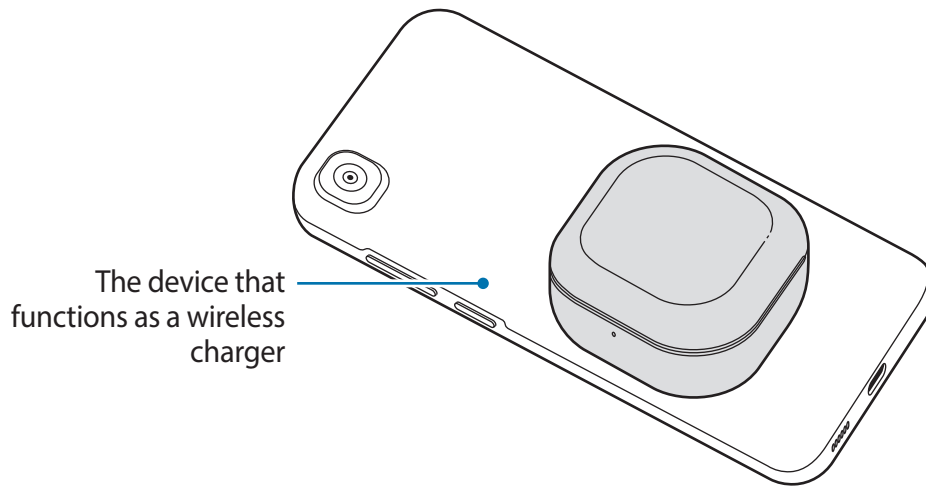

- 5 After fully charging, disconnect the charging case from the device that functions as a wireless charger.



- Only mobile devices that support the Wireless power sharing feature can charge the Galaxy Buds Pro. To see mobile devices that support the Wireless power sharing feature, visit the Samsung website.
- The location of the wireless charging coil may vary by device. Adjust the device and the charging case to make a strong connection.
- To charge properly, do not move or use either the device that functions as a wireless charger or the charging case while charging.
- The power charged to the Galaxy Buds Pro may be less than the amount shared to them by the device that functions as a wireless charger.
- If you charge the Galaxy Buds Pro while charging the device that functions as a wireless charger, the charging speed may decrease or the Galaxy Buds Pro may not charge properly, depending on the charger type.
- The charging speed or efficiency may vary depending on the device's condition or the surrounding environment.
- If the remaining battery power of the device that functions as a wireless charger drops below a certain level, power sharing will stop.

Checking the battery level

Connect the earbuds to your mobile device, launch the **Galaxy Wearable** app on the mobile device, and view the battery status of the earbuds and the charging case. Refer to [Connecting the earbuds to a mobile device](#) for more information.



 When the remaining battery level is low, a notification will appear on the mobile device's notification panel.

Battery indicator lights identification

The battery indicator lights inform you of your earbuds and the charging case's charging status.

The earbud battery indicator light is located inside of the charging case and shows the charging status of the earbuds. The charging case battery indicator light on the front of the charging case indicates the charging status of the case itself.

Earbud battery indicator light

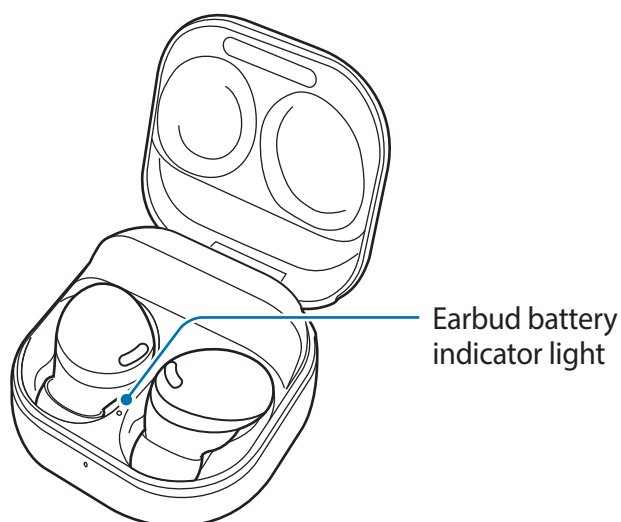

Colour	Status
Continuously red	• Charging
Continuously green	• Fully charged
Flashes red	• Charging blocked due to abnormal temperatures

Charging case battery indicator light

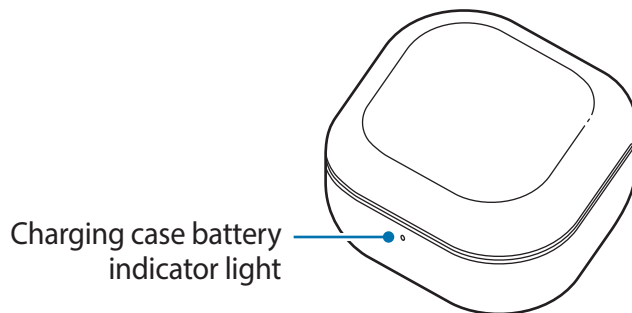

Colour	Status
Continuously red	• Charging
Continuously green	• Fully charged
Flashes red (rapid pace)	• Charging blocked due to abnormal temperatures
Flashes red (flashes after closing the charging case)	• Battery power is low (lower than 10 %)
Red (stays on for five seconds after closing the charging case)	• Battery power is low (between 10 % and 29 %)
Yellow (stays on for five seconds after closing the charging case)	• Battery power is moderate (between 30 % and 59 %)
Green (stays on for five seconds after closing the charging case)	• Battery power is high (more than 60 %)

- 📌 • The charging case battery indicator light flashes red when the external power is cut off during charging.
- If the battery indicator lights do not work as described, disconnect the charger from the charging case and reconnect it.
- The charging case battery indicator light will turn on only after inserting the earbuds into the charging case and closing it.

Using the earbuds

Connecting the earbuds to a mobile device

Before the connection

- Charge the charging case sufficiently.
- The Galaxy Wearable app must be installed on your mobile device. If the app is not installed on your mobile device, download the app from **Galaxy Store** or **Play Store**.
 -  • You can download the Galaxy Wearable app only on mobile devices running Android operating system 7.0 (API 24), or later, and with 1.5 GB of RAM or more.
 - You can change the language of the Galaxy Wearable app on your mobile device. Launch the **Settings** app on your mobile device and tap **General management** → **Language**. English may appear by default if the selected language on the Settings app is not supported on the Galaxy Wearable app.

Connecting the earbuds to a Samsung mobile device for the first time

- 1 Check the direction of each earbud and correctly insert them into their corresponding slots in the charging case.

If the earbud battery indicator light does not flash, connect the charging case to the charger and charge them for more than 10 minutes.
- 2 Close the charging case.

3 Open the charging case.

The earbuds will enter Bluetooth pairing mode automatically and a pop-up window will appear on your mobile device.

If the pop-up window does not appear or if you want to connect to a non-Samsung mobile device that also uses the Android OS, refer to [Connecting to a non-Samsung mobile device that also uses the Android OS \(or, the connection pop-up window does not appear\)](#).

 When the charging case battery indicator light flashes in red, take out the earbuds from the charging case and insert them into the case again.

4 On your mobile device, tap **Connect** on the pop-up window and follow the on-screen instructions to complete the connection.

Once the connection has been established, the earbuds will be automatically connected to your mobile device whenever you open the charging case while the earbuds are inside it.

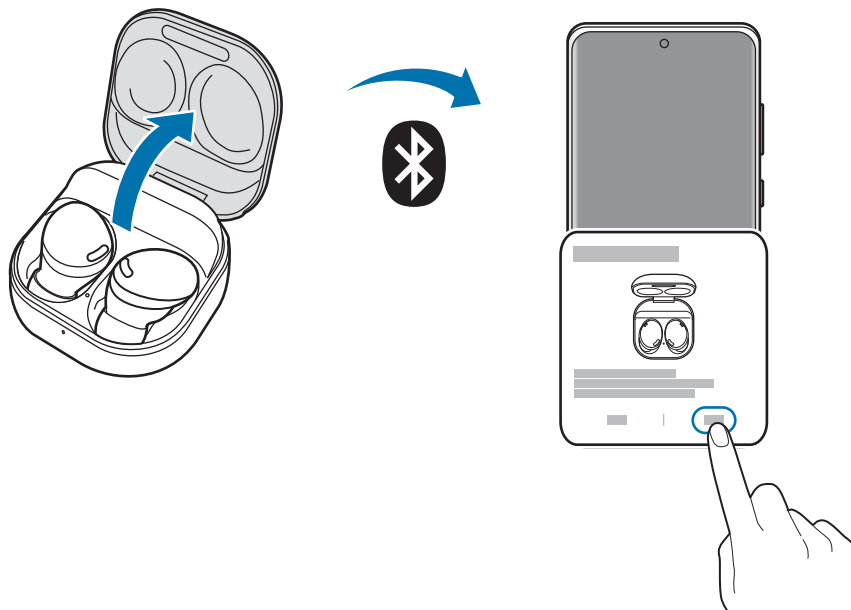

-  • The connection pop-up window will appear only on Samsung mobile devices running Android operating system 7.1.1 or later that have the SmartThings app installed. If the pop-up window does not appear, update the SmartThings app to the latest version.
- The appearance of the pop-up window may vary depending on your connected mobile device.



- If the earbuds do not connect to a mobile device within three minutes, Bluetooth pairing mode will be deactivated. Close the charging case again and open it. The earbuds will enter Bluetooth pairing mode.
- If you want to connect to another mobile device after a connection has been established, refer to [Connecting with other devices after disconnecting from the previous mobile device](#).
- When connecting earbuds with a mobile device that has been signed in to a Samsung account, the earbuds pairing information will be synced on the other mobile devices that use the same Samsung account and you do not need to pair them at the beginning again. To connect the other devices that use the same Samsung account with the earbuds, on the mobile devices that you want to connect, launch the **Settings** app, tap **Connections** → **Bluetooth**, and then select the earbuds synced through the Samsung account.
- If only a single earbud is connected to your mobile device, you will hear the sound in mono. It will automatically switch to stereo mode when both earbuds are connected to your mobile device.
- If the earbuds do not connect to a mobile device, the connection pop-up window does not appear, or your mobile device cannot find the earbuds, touch and hold both earbuds for more than three seconds while wearing them to enter Bluetooth pairing mode manually. When Bluetooth pairing mode is entered, you will hear a sound. However, you cannot use this method when you are playing music after setting the volume adjustment as a preset touch-and-hold feature.

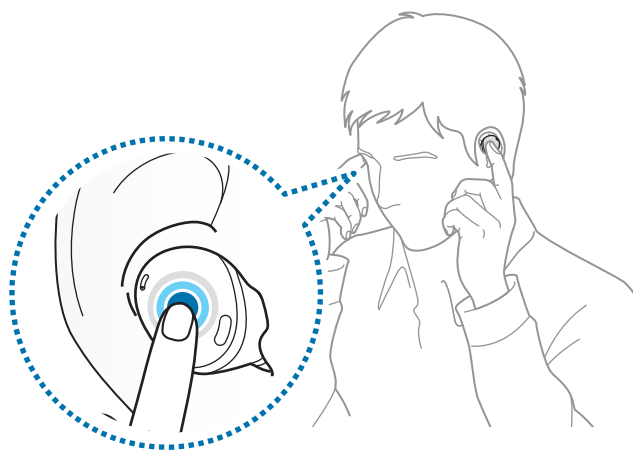

Connecting to a non-Samsung mobile device that also uses the Android OS (or, the connection pop-up window does not appear)

 If you connect to a non-Samsung mobile device that also uses the Android OS, some of the features of the earbuds may not be available and the earbuds may not work properly.

- 1 Check the direction of each earbud and correctly insert them into their corresponding slots in the charging case.

If the earbud battery indicator light does not flash, connect the charging case to the charger and charge them for more than 10 minutes.

- 2 Close the charging case.

- 3 Open the charging case.

The earbuds will enter Bluetooth pairing mode automatically.

- 4 On your mobile device, activate the Bluetooth feature to connect the earbuds to your mobile device, launch the **Galaxy Wearable** app, and then follow the on-screen instructions to complete the connection.

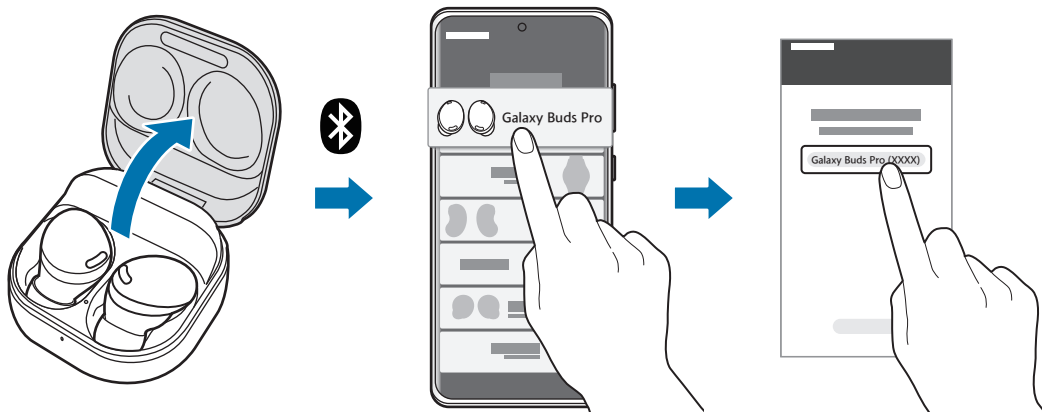

Tips and precautions when connecting to the mobile device

- If the earbuds do not connect to a mobile device within three minutes, Bluetooth pairing mode will be deactivated. Close the charging case again and open it. The earbuds will enter Bluetooth pairing mode.
- If you want to connect to another mobile device after a connection has been established, refer to [Connecting with other devices after disconnecting from the previous mobile device](#).

- If the earbuds do not connect to a mobile device, the connection pop-up window does not appear, or your mobile device cannot find the earbuds, touch and hold both earbuds for more than three seconds while wearing them to enter Bluetooth pairing mode manually. When Bluetooth pairing mode is entered, you will hear a sound. However, you cannot use this method when you are playing music after setting the volume adjustment as a preset touch-and-hold feature.
- Connection methods may vary depending on your device and software version.
- You can download the Galaxy Wearable app only on mobile devices running Android operating system 7.0 (API 24), or later, and with 1.5 GB of RAM or more.

Tips and precautions for using Bluetooth

Bluetooth is a wireless technology standard that uses a 2.4 GHz frequency to connect to various devices over short distances. It can connect and exchange data with other Bluetooth enabled devices, such as mobile devices, without connecting via cables.

Notices for using Bluetooth

- To avoid problems when connecting your earbuds to another device, place the devices close to each other.
- Ensure that your earbuds and the other Bluetooth device are within the maximum Bluetooth connection range (10 m). The distance may vary depending on the environment the devices are used in.
- Ensure that there are no obstacles between the earbuds and a connected device, including human bodies, walls, corners, or fences.
- Do not touch the Bluetooth antenna of a connected device.
- Bluetooth uses the same frequency as some industrial, scientific, medical, and low power products and interference may occur when making connections near these types of products.
- Some devices, especially those that are not tested or approved by the Bluetooth SIG, may be incompatible with the earbuds.
- Do not use the Bluetooth feature for illegal purposes (for example, pirating copies of files or illegally tapping communications for commercial purposes).

Wearing the earbuds

Adjust the earbuds to fit your ears.

- ⚠ • Your device contains magnets. Keep a safe distance between your device and objects that may be affected by magnets such as credit cards and implantable medical devices. If you have an implantable medical device, consult your physician before use.
- Keep a safe distance between your device and objects that are affected by magnets. Objects such as credit cards, passbooks, access cards, boarding passes, or parking passes may be damaged or disabled by the magnets in the device.
- 👉 • If the touch-sensitive sensor does not make contact with your ear, the earbud may not work. Use the ear tips that fit your ears if you do not hear a sound informing you that the earbud is detected.
- If the earbuds are not positioned correctly in your ears, they may not work. If this is the case, use a pair of ear tips that fit your ears and wear the earbuds properly.
- Follow all posted warnings and directions from authorised personnel in areas where the use of wireless devices is restricted, such as aeroplanes and hospitals.

1 Hold the upper and lower sides of each earbud and remove them from the charging case.

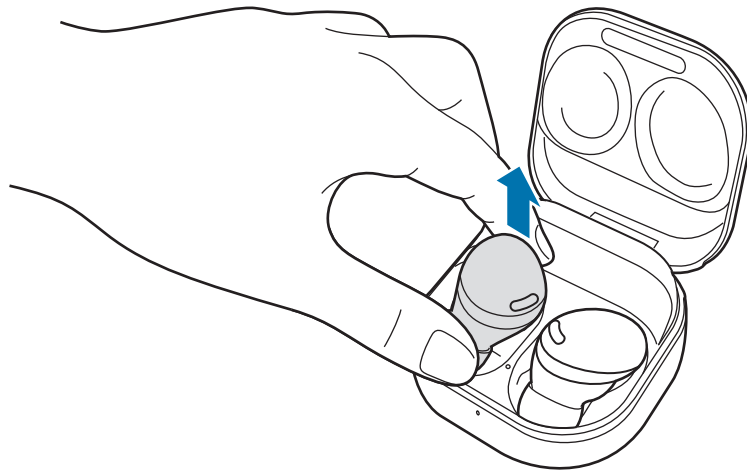

- 2 Check the direction of each earbud.
- 3 Hold the earbuds so that you see the imprinted direction marks, insert the earbuds into your ears, and then adjust the earbuds by rotating them until they sit comfortably in your ears.

The touch-sensitive sensors will detect that you are wearing the earbuds when you put them on. Then, the earbud will emit a sound informing you that the earbud is detected.

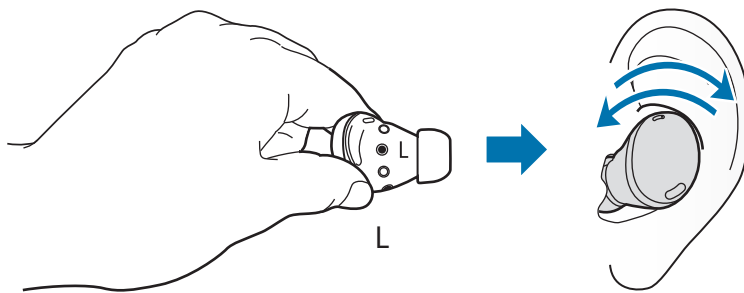

Using the earbud by touch

Introduction

Touch the earbud to play or stop music or answer or reject calls. You can also set the earbuds to perform other actions by touch.

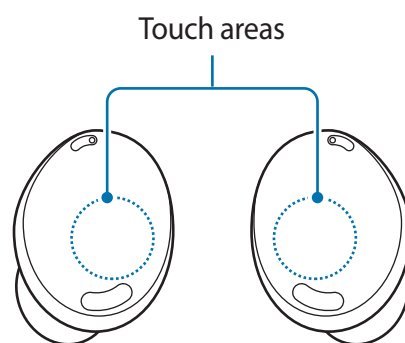

- To avoid hurting your ears, do not apply excessive pressure to the earbuds with your fingertips.
- To avoid damaging the touch areas, do not touch the earbuds with anything sharp.

Understanding touch actions

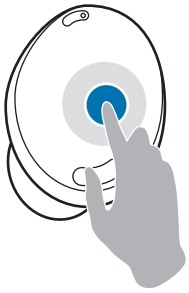

Single touch

- Play or pause track.
- Stop using the Text-to-Speech feature.



Double touch

- Play next track.
- Answer or end a call.
- Place the current call on hold and answer the second call.
- Switch between the current call and the held call.



Triple touch

- Play previous track.
 - If you touch the earbud three times three seconds after a track begins playing, it will start the track from beginning. Touch the earbud three times within three seconds of when a track begins playing to play the previous track.



Touch and hold

- Activate a preset feature.
 - It is set by default to activate the noise controls mode. Refer to [Setting a preset touch-and-hold feature](#) for more information about changing preset menus.
- Decline a call.



If the earbuds do not connect to a mobile device, the connection pop-up window does not appear, or your mobile device cannot find the earbuds, touch and hold both earbuds for more than three seconds while wearing them to enter Bluetooth pairing mode manually. When Bluetooth pairing mode is entered, you will hear a sound. However, you cannot use this method when you are playing music after setting the volume adjustment as a preset touch-and-hold feature.

Locking the earbuds' touch feature

You can prevent unintended actions by locking the earbuds' touch feature.

Activating from the Galaxy Wearable app

Launch the **Galaxy Wearable** app on the mobile device and tap the **Block touches** switch to activate it.

Activating from the Settings app

 This feature is available only on mobile devices running the Android One UI version 3.1 and later.

- 1 Launch the **Settings** app on your mobile device and tap **Connections** → **Bluetooth**.
- 2 Tap  next to the earbuds' name under **Paired devices**.
- 3 Tap the **Block touches** switch to activate it.

Activating from the widget

Add the **Galaxy Buds Pro** widget to the mobile device and tap the button to quickly lock the touch feature of the earbuds.

Setting a preset touch-and-hold feature

You can select a preset touch-and-hold feature of each earbud to activate features quickly and conveniently.

- 1 Launch the **Galaxy Wearable** app on the mobile device.
- 2 Tap **Touch and hold**.
- 3 Under **Left** or **Right**, select preset touch-and-hold features for each earbud.
 - **Switch noise controls:** The following features will be launched in order whenever you touch and hold the earbud: active noise cancelling and ambient sound mode. Refer to [Activating the noise controls mode](#) for more information.
 - **Voice command (Bixby):** Start a conversation with an intelligent voice assistant service. When using Bixby, refer to [Using Bixby](#) for more information.

- **Volume down/Volume up:** Adjust the volume.
-  • If you select the volume adjustment feature as one side's preset touch-and-hold feature, the other side's preset touch-and-hold feature is also automatically set to the volume adjustment feature.
- When the volume adjustment feature has been already selected and you try to change the one side's preset touch-and-hold feature, the other side's preset touch-and-hold feature is automatically set to activate the noise controls mode.

Using the noise controls mode

Introduction

There are two noise controls mode: active noise cancelling and ambient sound mode.

Activate the active noise cancelling feature to block out the external sounds around you. Use it when you want to avoid distractions, such as when listening to music. Conversely, activate the ambient sound mode to hear your surroundings clearly, so you can quickly detect any potentially dangerous situations or hear another person's voice during a conversation.

 If the microphone (the outer microphone while wearing the earbuds) and its area are covered completely, feedback may occur when launching the active noise cancelling feature.

 You can only activate the noise controls mode when wearing both earbuds in your ears.

Activating the noise controls mode

Activating from the earbuds

Make sure that the preset touch-and-hold feature is set to the noise controls mode and then touch and hold the earbud.

The following features will be launched in order whenever you touch and hold the earbud: active noise cancelling and ambient sound mode.

Activating from the Galaxy Wearable app

- 1 Launch the **Galaxy Wearable** app on the mobile device and tap **Active noise cancelling** or **Ambient sound**.

- 2 Select **High** or **Low** to adjust the active noise cancelling level under **Active noise cancelling level** or drag the **Ambient sound volume** adjustment bar to adjust its volume.

Activating from the Settings app

 This feature is available only on mobile devices running the Android One UI version 3.1 and later.

- 1 Launch the **Settings** app on your mobile device and tap **Connections** → **Bluetooth**.
- 2 Tap  next to the earbuds' name under **Paired devices**.
- 3 Tap **Active noise cancelling** or **Ambient sound** to activate it.

Activating from the widget

Add the **Galaxy Buds Pro** widget to the mobile device and tap the button to activate the noise controls mode quickly.

Activating the voice detect feature

You can set the device to activate ambient sound mode automatically in any situation when the earbuds detect that you are talking to other people. If ambient sound mode is activated, the media volume will be decreased to let you hear outside sounds or another person's voice clearly, allowing you to concentrate on the conversation. The earbuds return to the previously used mode automatically if they do not detect a voice for a certain period.

-  • The voice detection sensors of both earbuds detect your voice when using the voice detect feature. So, if you only wear an earbud in one ear, this feature may not be available.
- In the situations where vibrations are made, such as when you brush your teeth, cough, or hum, the earbuds may misinterpret the vibration as a voice.
 - You can deactivate ambient sound mode during conversations manually by touching and holding the earbud or from the Galaxy Wearable app.

- 1 Launch the **Galaxy Wearable** app on the mobile device.
- 2 Tap **Voice detect** and tap the switch to activate it.
- 3 Select the amount of time it will take to automatically deactivate the ambient sound mode.

Using Bixby

Introduction

Bixby is a user interface that helps you use your device more conveniently.

You can talk to Bixby. Bixby will launch a function you request or show the information you want on the connected mobile device.

-  • This feature is available only when a mobile device that supports Bixby is connected.
- Only some languages are available depending on Bixby set on your mobile device. Certain features may not be available depending on your region.

Using Bixby

- 1 Make sure you set a preset touch-and-hold feature for launching Bixby and touch and hold the earbud. Alternatively, say “Hi, Bixby”.

Bixby will be launched on your connected mobile device.

- 2 Say what you want to Bixby.

Bixby will launch the function you request or show the information you want on the connected mobile device when it recognises what you say through the earbuds.

To repeat what you said before or to say something new, touch and hold the earbud.

Waking up Bixby using your voice

You can start a conversation with Bixby by saying “Hi, Bixby” while wearing the earbuds.

- 1 Launch the **Galaxy Wearable** app on the mobile device and tap **Advanced**.
- 2 Tap the **Bixby voice wake-up** switch to activate it.

-  When you activate this feature, the Bixby voice wake-up feature on your connected mobile device will also be activated automatically.

Tips for better voice recognition

- Speak clearly.
- Speak in quiet places.
- Do not use offensive or slang words.
- Avoid speaking in dialectal accents.

The Galaxy Buds Pro may not recognise what you say or may perform unwanted commands depending on your surroundings or how you speak.

Listening to music

Listen to music saved in your mobile device by connecting the earbuds to the mobile device. You can stream music played from the connected mobile device.

On your mobile device, launch a music player app and play music.

Playing or pausing the track

Touch the earbud to play and pause the track.

Playing the next track

Double touch the earbud to play the next track.

Playing the previous track

Touch the earbud three times to play the previous track.



If you touch the earbud three times three seconds after a track begins playing, it will start the track from beginning. Touch the earbud three times within three seconds of when a track begins playing to play the previous track.

Adjusting the volume

You can adjust the volume by touching and holding the earbud after setting it as a preset touch-and-hold feature.



- Adjust the volume via your connected mobile device if a sound is low in your earbuds while at full volume.
- If you connect the earbuds to your mobile device while listening to music, the volume may change.
- If you select the volume adjustment feature as one side's preset touch-and-hold feature, the other side's preset touch-and-hold feature is also automatically set to the volume adjustment feature.

- 1 Launch the **Galaxy Wearable** app on the mobile device and tap **Touch and hold**.
- 2 Under **Left** or **Right**, select **Volume down** or **Volume up**.
- 3 Touch and hold the right earbud and release your finger when you reach the desired volume to increase the volume.
Touch and hold the left earbud and release your finger when you reach the desired volume to decrease the volume.

Using the equaliser

You can select from six different equaliser presets and enjoy the same music with a different and unique sound.

Launch the **Galaxy Wearable** app on the mobile device, tap **Equaliser**, and then select a preset you want.

Using call features

When the earbuds are connected to a mobile device, you can answer and control calls from the connected mobile device.

Answering or declining a call

When a call comes in while you are wearing the earbuds, they will emit a sound and a voice notification will inform you of the incoming call's phone number or the name saved in your contacts.

To answer the call, double touch the earbud.

To decline the call, touch and hold the earbud.

 If you are not notified of the incoming call's phone number or the name saved in your contacts via voice notification, launch the **Galaxy Wearable** app on the mobile device and tap **Read notifications aloud** → **See all**. Then, tap ▼, select **All**, and then tap the **Incoming call** switch to activate the feature.

Answering a second call

When a second call comes in during a call, the earbuds will emit a sound.

To stay on the current call and reject an incoming second call, touch and hold the earbud.

To place the current call on hold and answer the second call, double touch the earbud.

To switch between the current call and the held call, double touch the earbud during a call.

Ending a call

Double touch the earbud to end the current call.

Galaxy Wearable App

Introduction

To connect the earbuds to a mobile device, you must install the Galaxy Wearable app on your mobile device. Using the Galaxy Wearable app, you can view the Galaxy Buds Pro status and customise their settings.

Launch the **Galaxy Wearable** app on your connected mobile device.

- If it is the first time connecting the earbuds and a mobile device, refer to [Connecting the earbuds to a mobile device](#) for more information.
- Some features may not be available depending on the type of connected mobile device.

Access additional options.

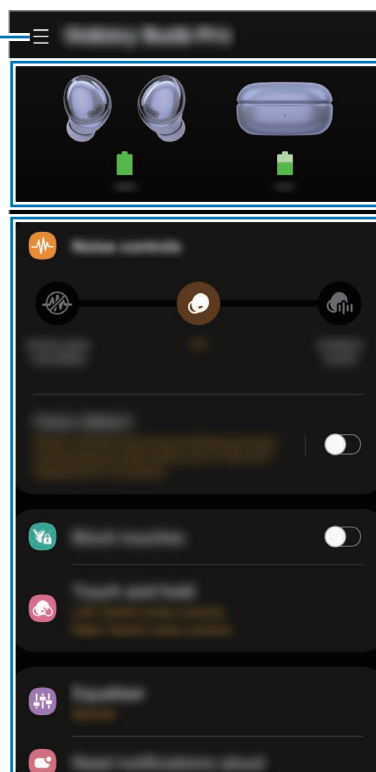

Galaxy Buds Pro's battery status

Customise your Galaxy Buds Pro settings

Connecting and disconnecting the earbuds

Disconnecting mobile devices from the earbuds

Insert the earbuds into the charging case and close it. The Bluetooth connection will end.

To manually disconnect the earbuds from your mobile device, launch the **Galaxy Wearable** app on the mobile device and tap  → **Disconnect**. Or, launch the **Settings** app on the mobile device, tap **Connections** → **Bluetooth**, and then unpair the earbuds from your mobile device under **Paired devices**.

Reconnecting mobile devices with the earbuds that temporarily disconnected

To reconnect the earbuds that temporarily disconnected from a device, insert them into the charging case and close it. Then, open the charging case again.

To manually reconnect the earbuds to your mobile device, launch the **Galaxy Wearable** app on the mobile device and tap **Connect**.

Connecting with new earbuds

You can temporarily disconnect the earbuds from your mobile device and connect additional ones.

Launch the **Galaxy Wearable** app on the mobile device and tap  → **Add new device**.

Connecting with other devices after disconnecting from the previous mobile device

- 1 Disconnect the earbuds from the previous mobile device. Launch the **Settings** app on the mobile device, tap **Connections** → **Bluetooth**, and then tap the switch to deactivate the Bluetooth feature. Alternatively, unpair the earbuds from your mobile device under **Paired devices**.
- 2 Close the charging case, open it again to enter Bluetooth pairing mode.
- 3 Launch the **Galaxy Wearable** app on your new mobile device and follow the on-screen instructions to complete the connection.

Switch the mobile devices connected with earbuds

When the earbuds are connected with two or more mobile devices, you can switch the mobile devices easily without disconnecting from the previous mobile device.

On the mobile device that you want to switch to, launch the **Settings** app, tap **Connections** → **Bluetooth**, and then select earbuds under **Paired devices**.

 The connections between your earbuds and the mobile devices can be switched automatically under the circumstances. For example, when your earbuds are registered on both a tablet and a smartphone, you can receive an incoming call from the smartphone with your earbuds while watching a video on the tablet since the earbuds' connection is switched to the smartphone automatically.

Viewing Galaxy Buds Pro status and customising settings

View the status of the Galaxy Buds Pro that are connected to your mobile device and change their settings.

Launch the **Galaxy Wearable** app on the mobile device.

 Some features, such as the noise controls mode or Bixby voice wake-up, may affect the usage time of your earbuds.

Setting the noise controls mode

Activate or deactivate the active noise cancelling or ambient sound mode based on your situation or surroundings. Also, you can set the ambient sound mode to activate automatically.

Launch the **Galaxy Wearable** app on the mobile device and select a feature and change its settings.

- **Active noise cancelling:** Activate the active noise cancelling feature.
- **Off:** Deactivate the noise controls mode.
- **Ambient sound:** Activate the ambient sound mode.
- **Active noise cancelling level:** Adjust the active noise cancelling level.
- **Ambient sound volume:** Adjust the ambient sound volume.
- **Voice detect:** Set the ambient sound mode to activate automatically when the earbuds detect a voice.

Block touches

Lock the earbuds' touch feature.

Launch the **Galaxy Wearable** app on the mobile device and tap the **Block touches** switch to activate it.

Touch and hold

Select a feature to be used as a preset touch-and-hold feature.

Launch the **Galaxy Wearable** app on the mobile device and tap **Touch and hold**. Refer to [Setting a preset touch-and-hold feature](#) for more information.

Equaliser

Select an equaliser preset you want to use.

Launch the **Galaxy Wearable** app on the mobile device, tap **Equaliser**, and then select an equaliser preset you want.

Read notifications aloud

You will receive notifications from the mobile device's apps via the earbuds.

Launch the **Galaxy Wearable** app on the mobile device and tap **Read notifications aloud**.

- **Read aloud while using phone:** Set the earbuds to receive notifications of the mobile device even when you are using the mobile device.
- **App notifications to read aloud:** Select the apps you want to receive notifications from and change the notification settings for each app.

Advanced

Activate advanced features of the Galaxy Buds Pro.

Launch the **Galaxy Wearable** app on the mobile device and tap **Advanced**.

- **Bixby voice wake-up:** Wake Bixby by voice to start a conversation with an intelligent voice assistant service.
- **Seamless earbud connection:** You can quickly change the mobile device to connect your earbuds with. Activate the feature to quickly switch the connection from the current mobile device to a nearby mobile device logged in via the same Samsung account or a device that has previously connected with your earbuds.

 Be careful to not connect your earbuds to another person's mobile device.

- **360 audio:** Provide 360-degree surround sound for an immersive environment while enjoying media.
 -  • This feature is available only on mobile devices running the Android One UI version 3.1 and later.
 - You can enjoy the higher quality audio if you place the connected mobile device closer to you.
 - This feature may not be supported because of how the media is played.
 - When you are in areas with poor signal reception, the connection to the mobile device may be lost temporarily.
- **Hearing enhancements:** You can adjust the volume's right and left balance if you have a hearing impairment or if using a single earbud is more convenient. Drag the **Left/right sound balance** adjustment bar to adjust the balance. If you drag the bar to the left, the left earbud's volume will increase and vice versa.

Labs

Minimise audio delay to remove the time lag from the video and sound output, and listen to vivid sound when launching a game.

Launch the **Galaxy Wearable** app on the mobile device, tap **Labs**, and then tap the **Gaming mode** switch to activate it.

-  This feature is available only when connecting with a Samsung mobile device that uses the Android OS.

Find My Earbuds

If you misplace your earbuds, use the Galaxy Wearable app on your mobile device to find it.

- 1 Launch the **Galaxy Wearable** app on the mobile device and tap **Find My Earbuds**.
- 2 Tap **Start**.
You will hear a beeping sound from your earbuds and that will become louder.
- 3 Tap **Stop** to stop the beeping sound for both earbuds.
Tap  under each earbud to stop the beeping sound for each earbud separately.

-  You can also find your earbuds using the SmartThings Find feature on the SmartThings app. When launching the **Galaxy Wearable** app on a mobile device that supports the feature and tapping **Find My Earbuds**, the SmartThings Find screen will appear and you can check your misplaced earbuds' location on the map. Also, you can find them by following the beeping sound emitted from your earbuds.

General

You can reset all your earbuds settings.

Launch the **Galaxy Wearable** app on the mobile device and tap **General** → **Reset**.

Earbuds software update

Update your earbuds' software via the firmware over-the-air (FOTA) service.

Launch the **Galaxy Wearable** app on the mobile device and tap **Earbuds software update**.

- **Download and install:** Check for and install updates manually.
- **Last update:** View the information for the latest software update.

Tips and user manual

View how to use the Galaxy Buds Pro.

Launch the **Galaxy Wearable** app on your mobile device and tap **Tips and user manual** to view the quick tips for using the Galaxy Buds Pro. Tap **User manual** to view the full user manual.

About earbuds

View the information of the Galaxy Buds Pro.

Launch the **Galaxy Wearable** app on the mobile device and tap **About earbuds**.

To change your Galaxy Buds Pro's name, tap **Edit**.

- **Legal information:** View the legal information for the Galaxy Buds Pro.
- **Software information:** View the earbuds' software information.
- **Battery information:** Check the earbuds and charging case's battery information.

Appendix

Troubleshooting

Before contacting a Samsung Service Centre, please attempt the following solutions. Some situations may not apply to your Galaxy Buds Pro.

Your earbuds do not work

- The battery may be completely discharged. Charge the battery completely before using the earbuds.
- If an earbud's touch-sensitive sensor does not make contact with your ear, the earbud may not work. If you do not hear a sound informing you that the earbuds are detected, remove the earbuds from your ears and put them in again.
- If the earbuds' touch feature becomes unresponsive or the earbuds do not work properly, insert the earbuds into their corresponding slots in the charging case, close the charging case, and then remove them after seven seconds or more.

Bluetooth device cannot locate your earbuds

- Close the charging case again and open it to enter the Bluetooth pairing mode.
- Ensure that your earbuds and the other Bluetooth device are within the maximum Bluetooth connection range (10 m). The distance may vary depending on the environment the devices are used in.

If the tips above do not solve the problem, contact a Samsung Service Centre.

A Bluetooth connection is not established or your earbuds and the mobile device are disconnected

- Ensure there are no obstacles, such as walls or electrical equipment, between the devices.
- Ensure that the latest version of the Galaxy Wearable app is installed on the mobile device. If necessary, update the Galaxy Wearable app to the latest version.
- Ensure that your earbuds and the other Bluetooth device are within the maximum Bluetooth connection range (10 m). The distance may vary depending on the environment the devices are used in.
- Restart the mobile device and relaunch the **Galaxy Wearable** app.
- If only a single earbud is connected to your mobile device, restart the earbuds to connect them both. To restart the earbuds, refer to [Restarting the earbuds](#) for more information.

The battery does not charge properly (For Samsung-approved chargers)

- Ensure that the charging contacts of the earbuds and the charging contacts of the charging case are in contact with each other.
- Ensure that the charger is connected properly to the charging case.
- If the charging contacts are dirty, the battery may not charge properly. Wipe the charging contacts with a dry cloth and try charging the battery again.

If the tips above do not solve the problem, contact a Samsung Service Centre.

The charging time and the battery life is different between the earbuds

- The charging time may differ between the two earbuds even if they started charging at the same time.
- The charging time and the remaining battery may differ between the two earbuds due to different inner components.

The battery depletes faster than when first purchased

- When you expose the Galaxy Buds Pro to very cold or very hot temperatures, the useful charge may be reduced.
- The battery is consumable and the useful charge will get shorter over time.
- When you are not using the earbuds, do not wear them, but store them in the charged charging case. The touch-sensitive sensor will continue to work while wearing the earbuds and reduce the usage time even though you are not using the earbuds. Also, the batteries of earbuds which are not being stored in the charging case will drain.

You cannot hear others speaking

Adjust the volume on the connected mobile device.

Sound echoes during a call

Adjust the volume on the connected mobile device or move to another area.

Sound is emitted from the connected mobile device, not the earbuds, during a call

- Check if you are wearing the earbuds properly. If worn improperly, you will not be able to hear the call audio through the earbuds, even if the Bluetooth icon appears on the connected mobile device.
- Remove the earbuds from your ears and put them in again.

Audio quality is poor

- Wireless network services may be disabled due to issues with the service provider's network. Ensure to keep the earbuds away from electromagnetic waves.
- Ensure that your earbuds and the other Bluetooth device are within the maximum Bluetooth range (10 m). The distance may vary depending on the environment the devices are used in.
- You may experience drops in volume or noise depending on the connected device's volume. To avoid this, appropriately adjust the connected device's sound.

Your earbuds sound comes slower than the screen when playing videos and games

The earbuds may have a time lag between the video and sound output when playing videos or games when connected to a mobile device.

The noise controls mode does not work well

- Wear both earbuds in your ears and launch active noise cancelling, which is one of the noise controls mode. If you are unsure if the active noise cancelling feature is activated, check it on the Galaxy Wearable app.
- Check whether there is a buildup of foreign materials in the microphones located at the top and bottom of the earbuds, and clean them if required.
- Ensure that the latest software version is installed on the earbuds.

Your Galaxy Buds Pro are hot to the touch

When you use the Galaxy Buds Pro for an extended period of time, they may feel hot to the touch. This is normal and should not affect your Galaxy Buds Pro's lifespan or performance.

If the Galaxy Buds Pro overheat or feel hot for a prolonged period, do not use them for a while. If the Galaxy Buds Pro continue to overheat, contact a Samsung Service Centre.

A small gap appears around the outside of the Galaxy Buds Pro

- This gap is a necessary manufacturing feature and some minor rocking or vibration of parts may occur.
- Over time, friction between parts may cause this gap to expand slightly.

Managing the Galaxy Buds Pro

Basic maintenance

- Use a soft, dry cloth to clean the earbuds after use.
- Keep the earbuds dry. Prevent liquid from contacting or entering the earbuds.
- Clean the earbuds regularly to prevent earwax or debris from building up in the speaker and the air duct.

Cleaning the speaker and the air duct

If the volume is lower than it should be with the current setting, clean the speaker and the air duct. Before cleaning the speaker, detach the ear tip from the latch at the bottom of the earbud.

Remove any earwax or debris with a clean, dry, and soft brush, cotton swabs, or other tools.

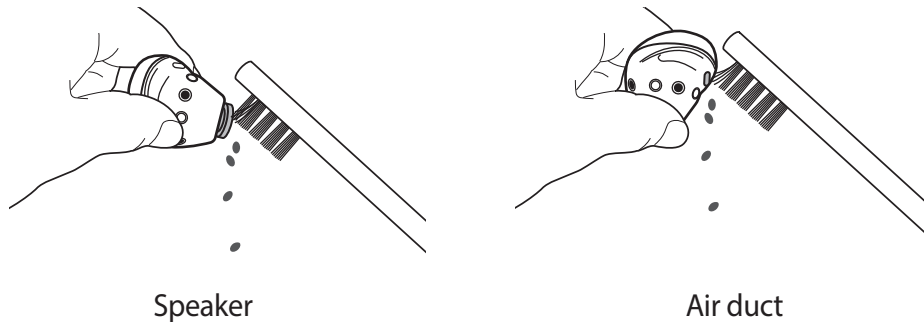

! Do not use anything sharp or excessive force while removing earwax or debris. The speaker and the air duct may be damaged.

Cleaning the charging contacts

If the battery does not charge properly, wipe the charging contacts with a dry cloth.

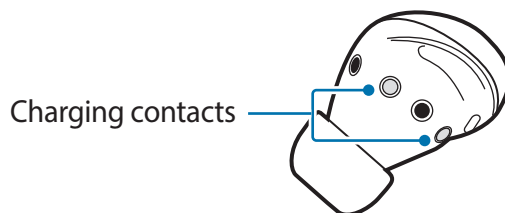

Cleaning the earbuds and charging case

When the charging case and earbuds are exposed to foreign materials, such as dust, sand, or metal shavings, the Galaxy Buds Pro may not charge properly or may be damaged. If the earbuds or the charging case were exposed to foreign materials, wipe them with a soft and dry cloth before inserting them into the charging case.

Restarting the earbuds

If the earbuds' touch feature becomes unresponsive or the earbuds do not work properly, restart the earbuds.

To restart the earbuds, insert the earbuds into their corresponding slots in the charging case and remove them after seven seconds or more.

 If the charging case has low battery, connect the charging case to the charger first.

Coupling the earbuds

When you lose one of the earbuds, you do not have to purchase a new set of earbuds because you can make a new set of earbuds with a newly purchased earbud and the other earbud that you already have.

1 Check the direction of each earbud, the newly purchased earbud and previously used earbud, and correctly insert them into their corresponding slots in the charging case.

2 Touch and hold both earbuds for seven seconds or more.

The earbud battery indicator light will flash green and turn off. Then, the earbuds are coupled.

 The earbud battery indicator light will keep flashing red when the earbuds are not coupled properly. Remove the earbuds from the charging case and insert them again. Then, touch and hold both earbuds for seven seconds or more.

3 Connect the earbuds to a mobile device. For more information, refer to [Connecting the earbuds to a mobile device](#).

Removing the battery

- **To remove the battery, contact an authorised service centre. To obtain battery removal instructions, please visit www.samsung.com/global/ecodesign_energy.**
- For your safety, you **must not attempt to remove** the battery. If the battery is not properly removed, it may lead to damage to the battery and device, cause personal injury, and/or result in the device being unsafe.
- Samsung does not accept liability for any damage or loss (whether in contract or tort, including negligence) which may arise from failure to precisely follow these warnings and instructions, other than death or personal injury caused by Samsung's negligence.

Copyright

Copyright © 2021 Samsung Electronics Co., Ltd.

This manual is protected under international copyright laws.

No part of this manual may be reproduced, distributed, translated, or transmitted in any form or by any means, electronic or mechanical, including photocopying, recording, or storing in any information storage and retrieval system.

Trademarks

- SAMSUNG and the SAMSUNG logo are registered trademarks of Samsung Electronics Co., Ltd.
- Bluetooth® is a registered trademark of Bluetooth SIG, Inc. worldwide.



- All other trademarks and copyrights are the property of their respective owners.

Model: SM-R190

Rated voltage/current: 5 V / 120 mA (earbuds), 5 V / 500 mA (charging case), 3.7 V (internal battery)

Made in Vietnam by Samsung

PO BOX 12987, DUBLIN, IE

